

° Custom/standard/special aluminum profiles

° Heat sinks in bars

° Heat sinks
HIGH PERFORMANCE

° LED Heat Sinks

° Heat sinks machined to design and anodized

° Card holders for electronics in aluminum type DIN 43700

° Modular structural profiles for robotics

° Modular structural profiles for PHOTOVOLTAIC installations



OMAR s.r.l.
PROFILATI ALLUMINIO
ALTA TECNOLOGIA

The "many forms" of the aluminum billet
Round Aluminum Heat Sinks
for LED Lighting

December 2024 Edition

Consult the updated catalog
online at:

www.omar-alluminio.it

www.omar-alluminio.com

www.led.sm

° Profiles for pneumatics

° Profiles for stands

° Skirting board profiles
skirting board wire covers

° Products derived from
aluminum profiles

° Machining
aluminum profiles

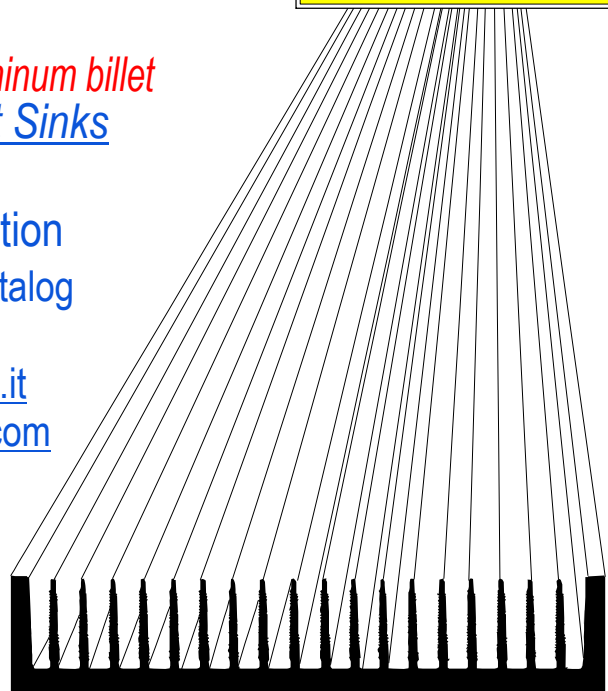
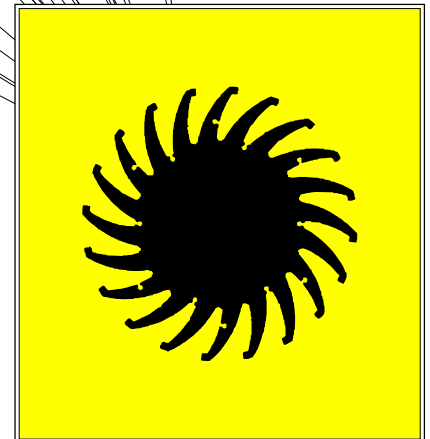
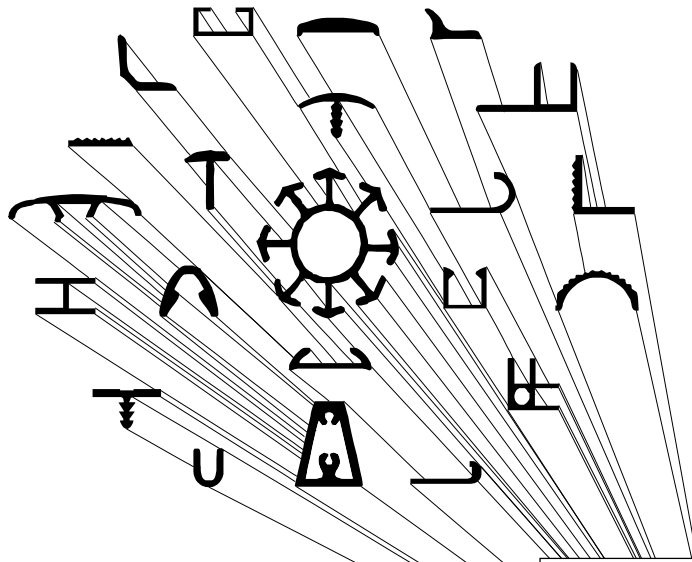

Via Newton, n.12
20016 Pero (Milano - Italy)
Tel.+39 02 3535955 r.a.
Fax.+39 02 3539929
E.Mail: info@omar-alluminio.it

ALUMINUM PROFILES
CUSTOM-DECORATED-STANDARD-SPECIAL



ED: ELECTRONICS-LED-PHOVOLTAIC
AUTOMATION-ROBOTICS-PNEUMATICS-AUTOMOTIVE

Heat sinks for LED light sources

Solid State Lighting - LED

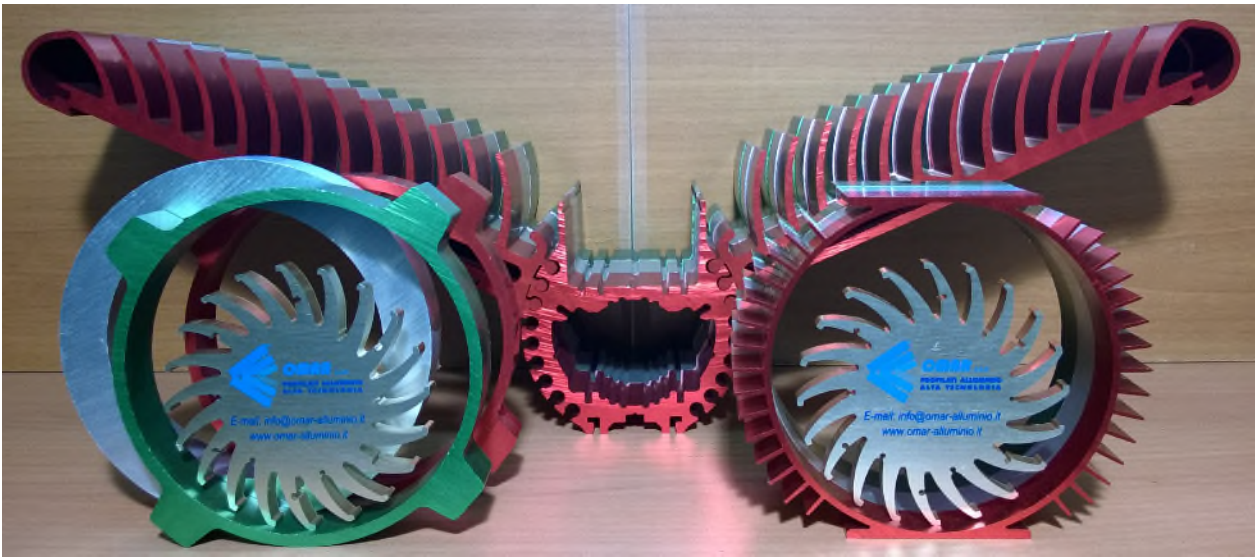

IN ADDITION TO THE PROFILES SHOWN IN THE CATALOGUE,
WE ARE ABLE TO SUPPLY HEAT SINKS IN BARS WITH 'CUSTOM'
SHAPES EVEN FOR SMALL QUANTITIES.

ALL PROFILES ARE AVAILABLE IN THE FOLLOWING FORMATS:

- 3 / 4 METER BARS
- CUT TO SIZE (RAW/OXIDIZED)
- COMPLETELY MACHINED ACCORDING TO YOUR DRAWING

WE ARE ABLE TO SUPPLY:

- CUSTOM SECTIONS ALSO FOR LITTLE QUANTITY
- CUSTOM DRILLINGS

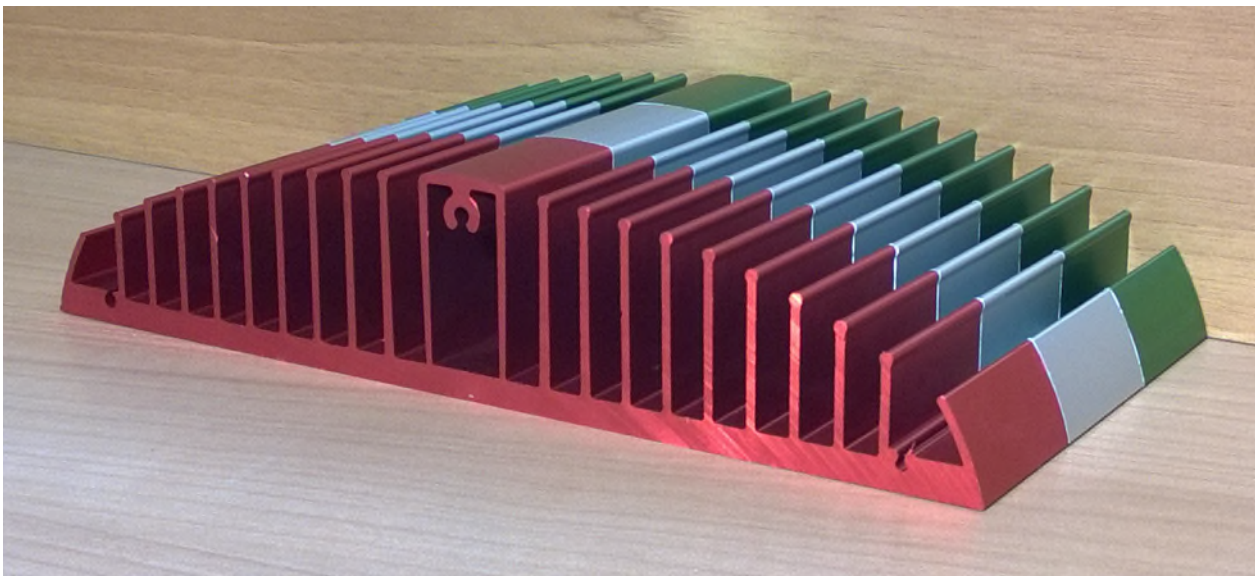

Cataloghi Online: www.omar-alluminio.it

www.omar-alluminio.com

CUSTOM ALUMINUM PROFILES / STANDARD / SPECIAL / AND FOR:

ELECTRONICS / LED / PHOTOVOLTAIC / ROBOTIC AUTOMATION / PNEUMATICS / AUTOMOTIVE

Via Newton, n.12

20016 Pero (Milano - Italy)

Tel. +39 02 3535955 r.a. Fax. +39 02 3539929

E-Mail: info@omar-alluminio.it



Aluminum heat sinks for Led lighting

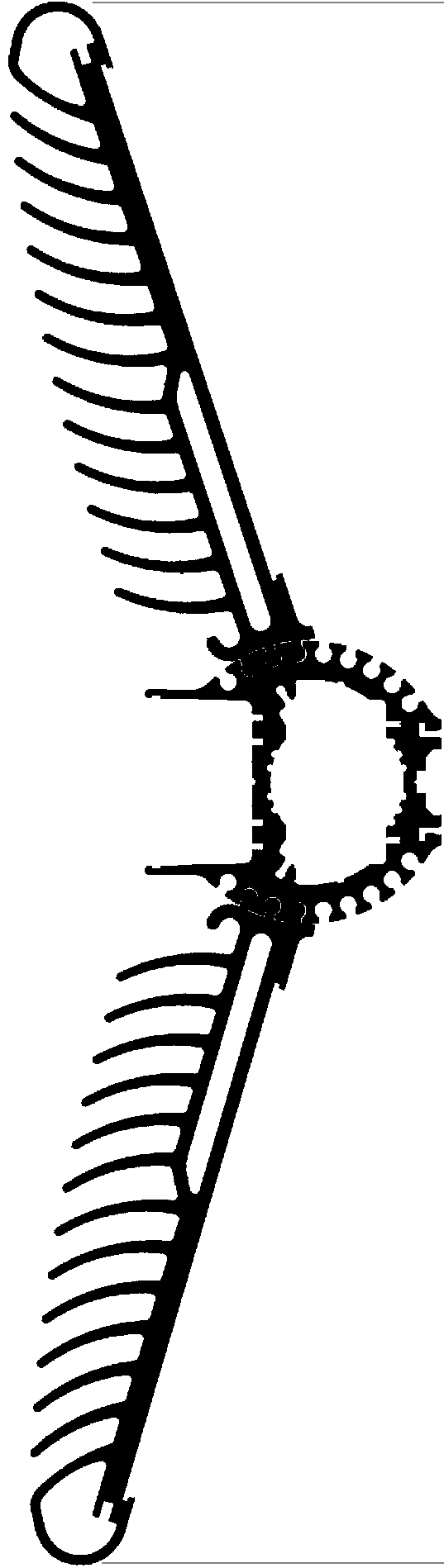

2274* *PRIVATE PROFILE OUT OF SCALE DRAWING 630

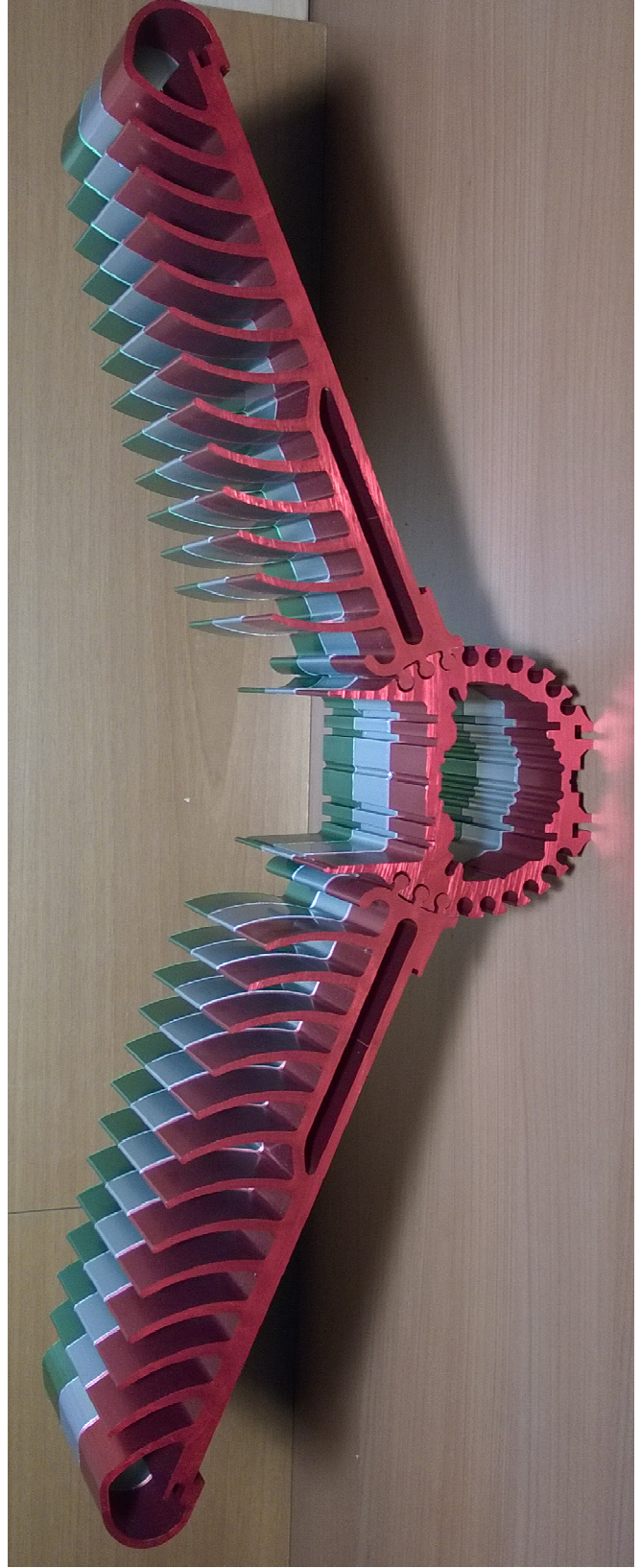

Aluminum heat sinks for Led lighting

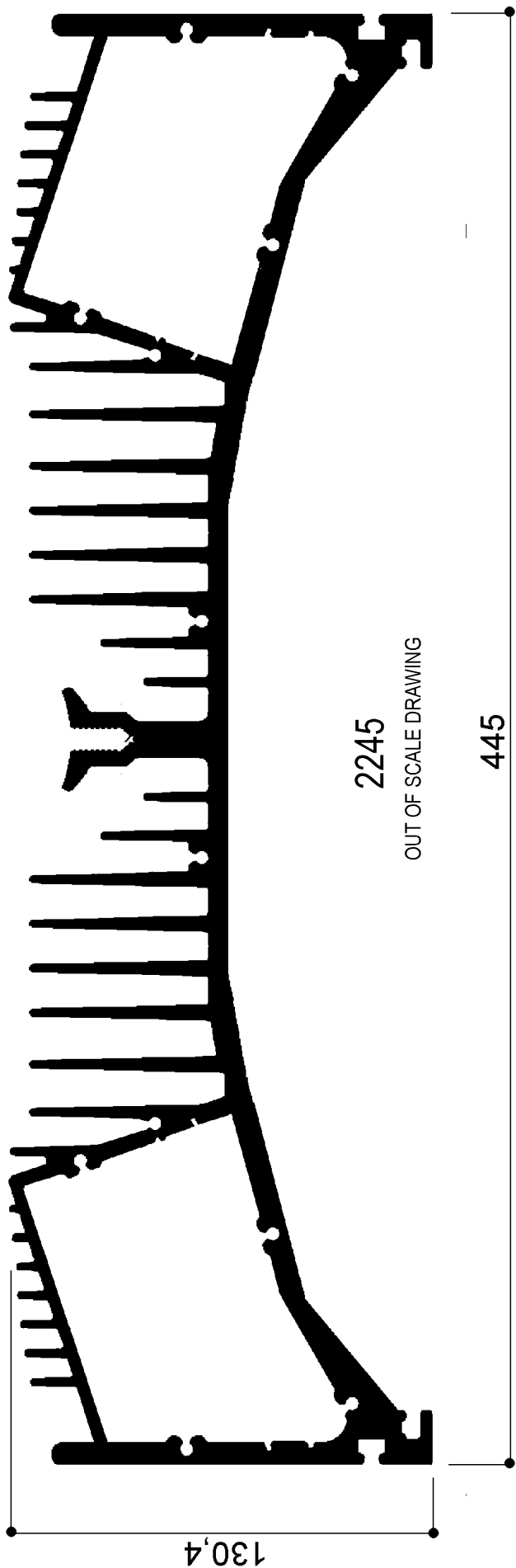

2245

OUT OF SCALE DRAWING

445

130,4

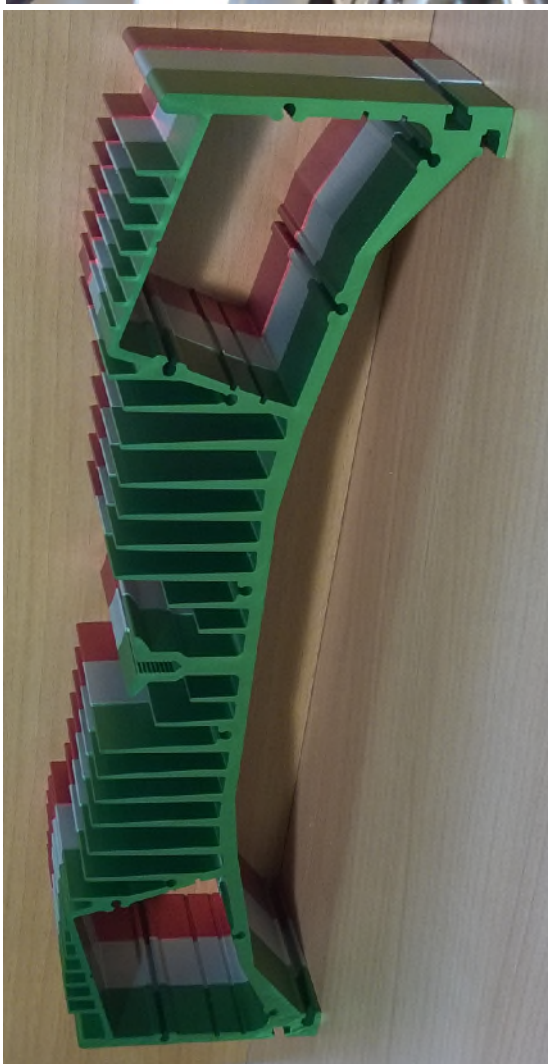

Cataloghi Online: www.omar-alluminio.it

www.omar-alluminio.com

CUSTOM ALUMINUM PROFILES / STANDARD / SPECIAL / AND FOR:

ELECTRONICS / LED / PHOTOVOLTAIC / ROBOTIC AUTOMATION / PNEUMATICS / AUTOMOTIVE

Via Newton, n.12

20016 Pero (Milano - Italy)

Tel. +39 02 3535955 r.a. Fax. +39 02 3539929

E.Mail: info@omar-alluminio.it

Aluminum heat sink for LED lighting

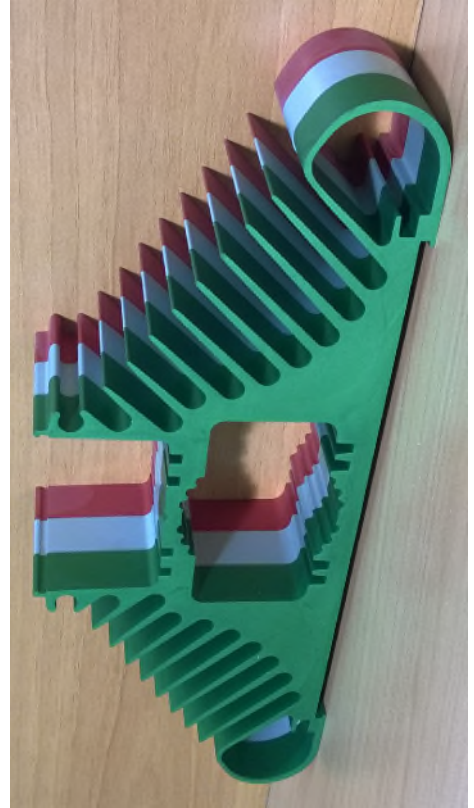
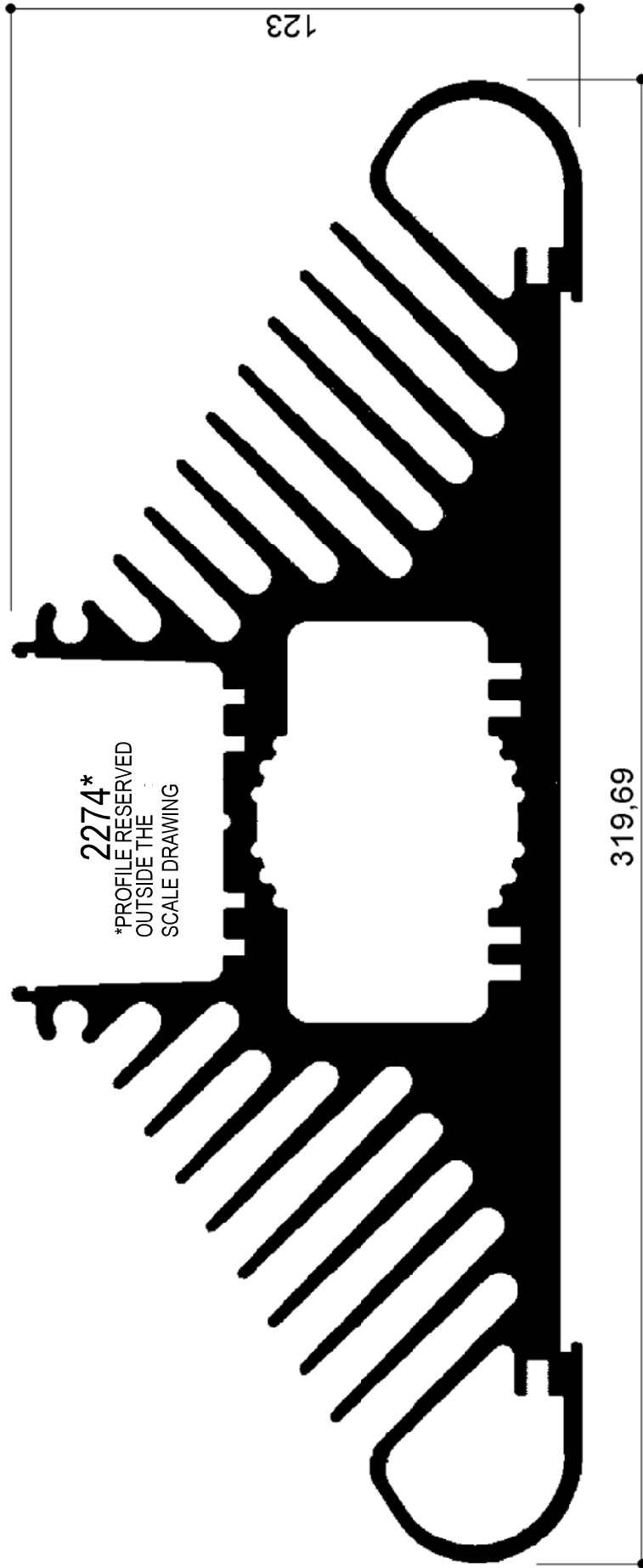

Aluminum heat sinks for Led lighting

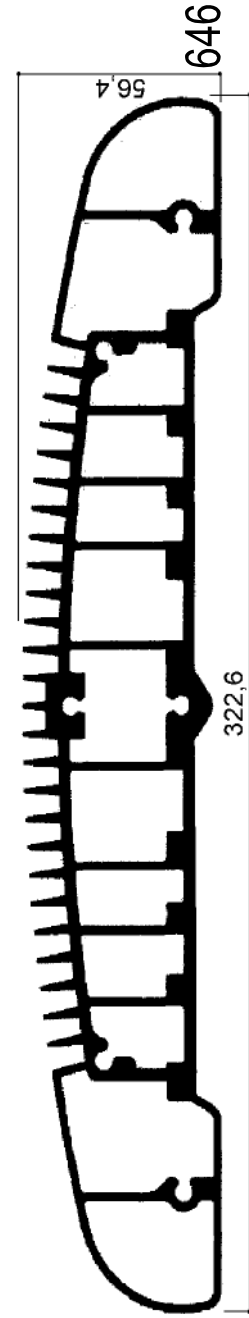
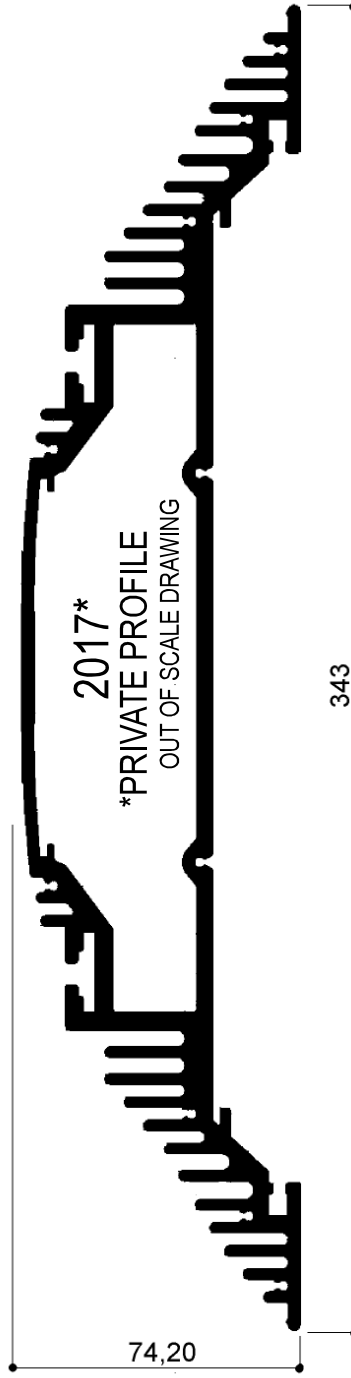
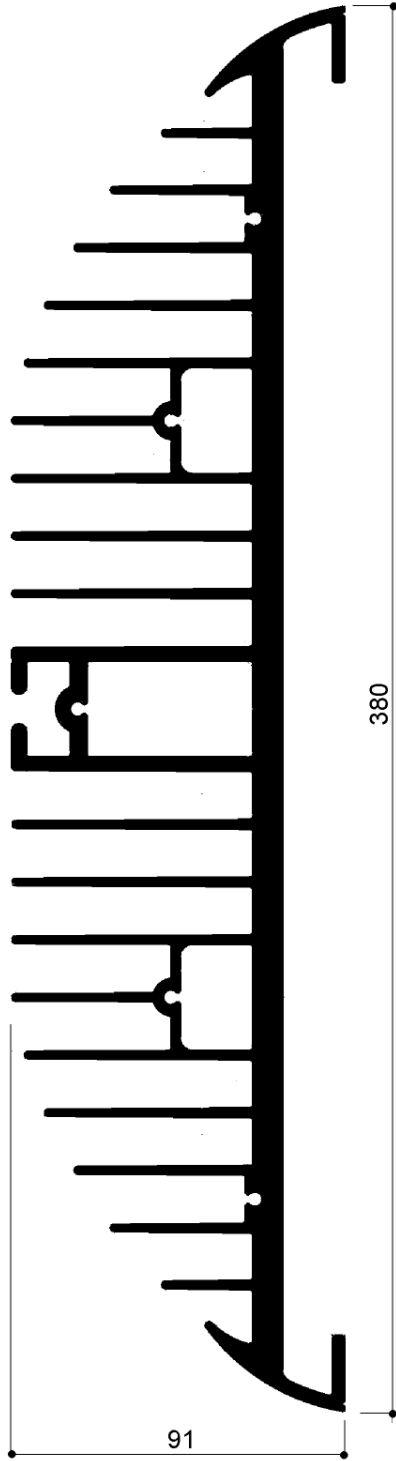

*PRIVATE PROFILE
OUT OF SCALE DRAWING

Cataloghi Online: www.omar-alluminio.it

www.omar-alluminio.com

CUSTOM ALUMINUM PROFILES / STANDARD / SPECIAL / AND FOR:

ELECTRONICS / LED / PHOTOVOLTAIC / ROBOTIC AUTOMATION / PNEUMATICS / AUTOMOTIVE

Via Newton, n.12

20016 Pero (Milano - Italy)

Tel. +39 02 3535955 r.a. Fax. +39 02 3539929

E.Mail: info@omar-alluminio.it



Aluminum heat sinks for Led lighting



LIFE DRAWINGS (1:1) - 1:1 SCALE

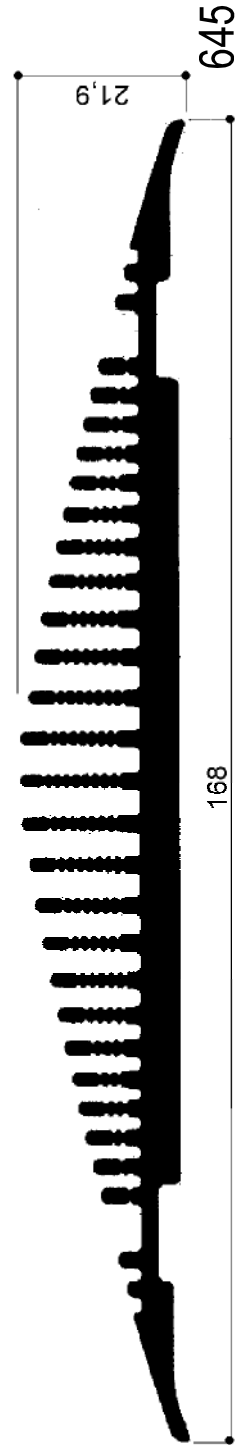
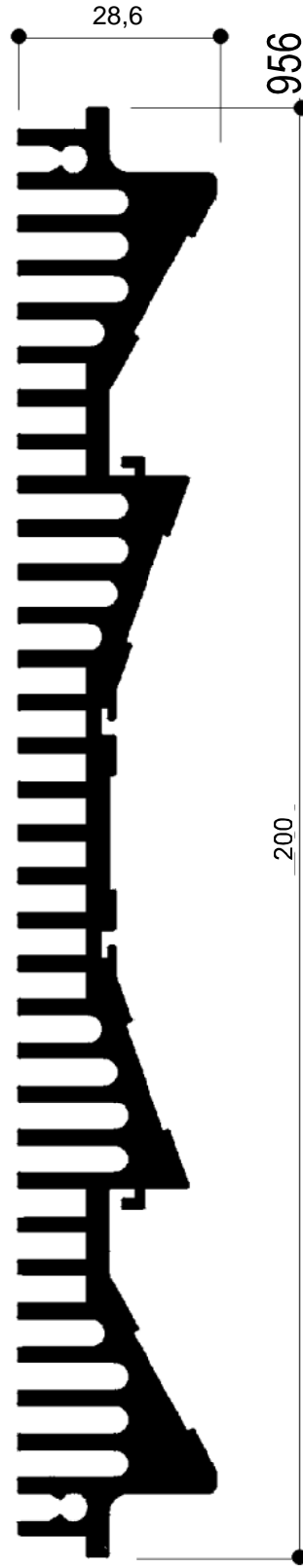
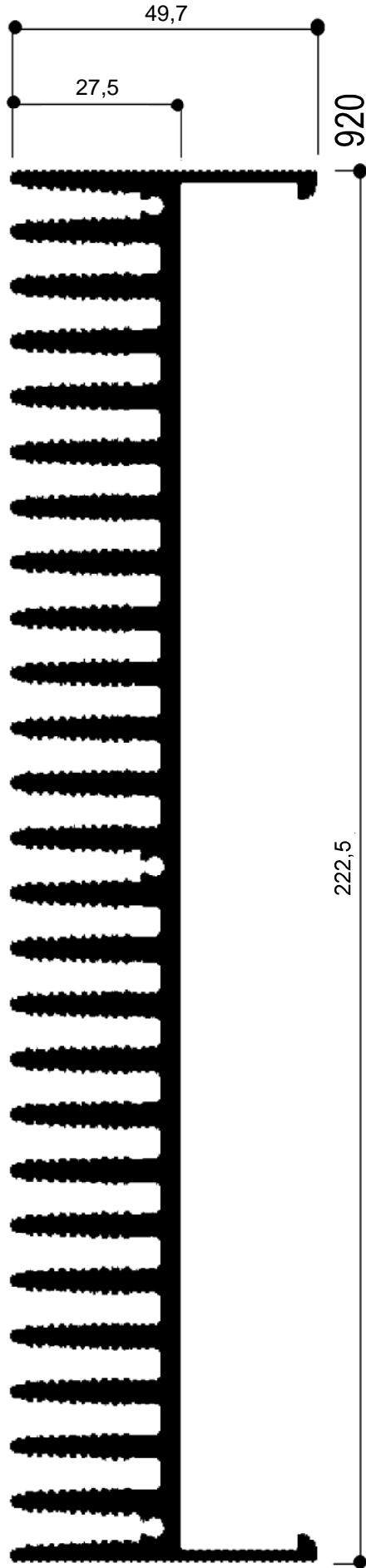

Aluminum heat sinks for Led lighting



OUT OF SCALE DRAWING

*PRIVATE PROFILE

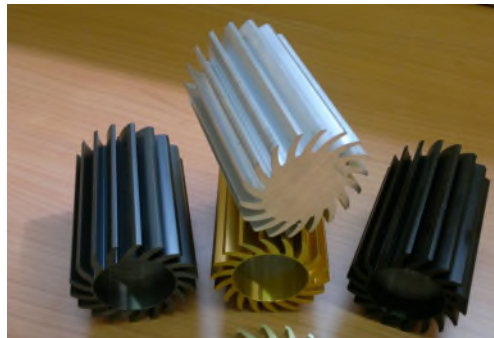
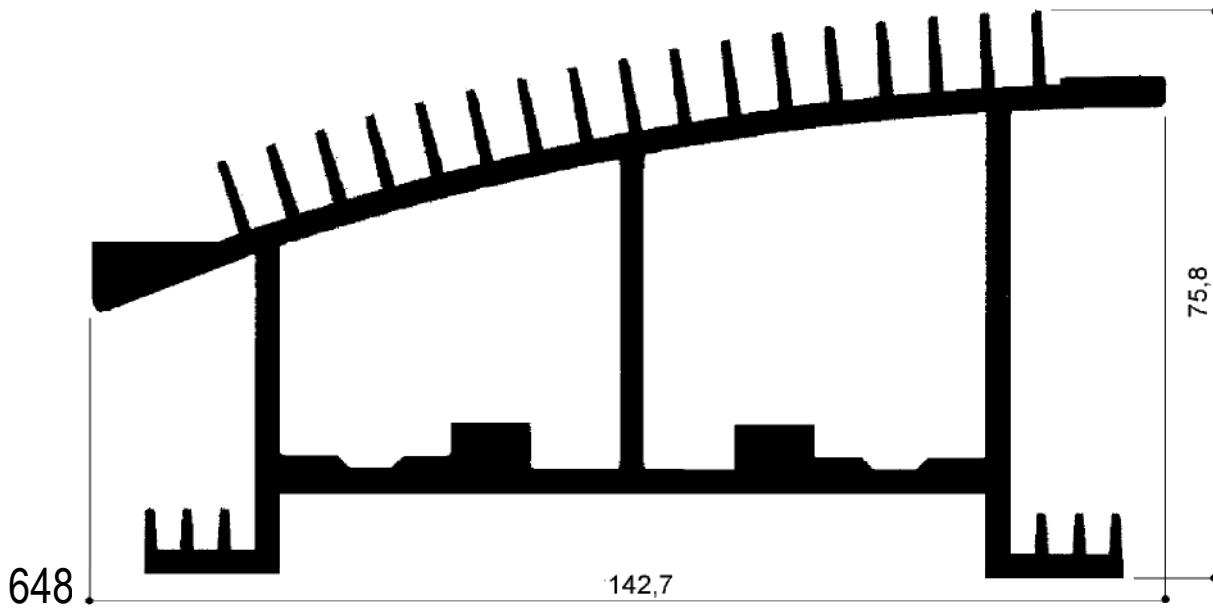

Cataloghi Online: www.omar-alluminio.it

www.omar-alluminio.com

CUSTOM ALUMINUM PROFILES / STANDARD / SPECIAL / AND FOR:

ELECTRONICS / LED / PHOTOVOLTAIC / ROBOTIC AUTOMATION / PNEUMATICS / AUTOMOTIVE

Via Newton, n.12

20016 Pero (Milano - Italy)

Tel. +39 02 3535955 r.a. Fax. +39 02 3539929

E.Mail: info@omar-alluminio.it



Aluminum heat sinks for Led lighting



LIFE DRAWINGS (1:1) - 1:1 SCALE

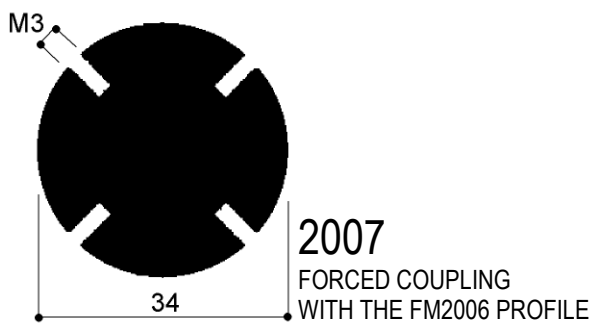
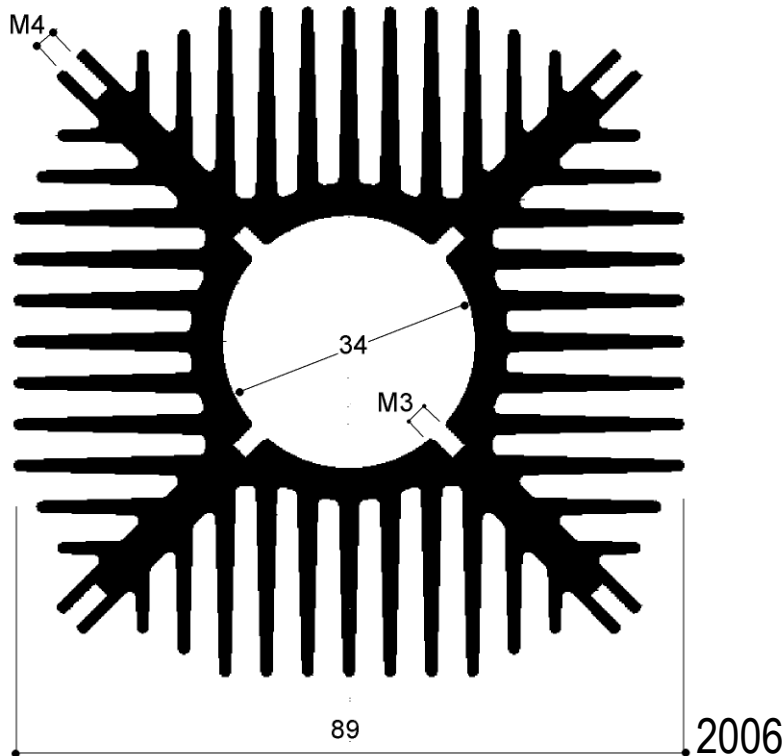
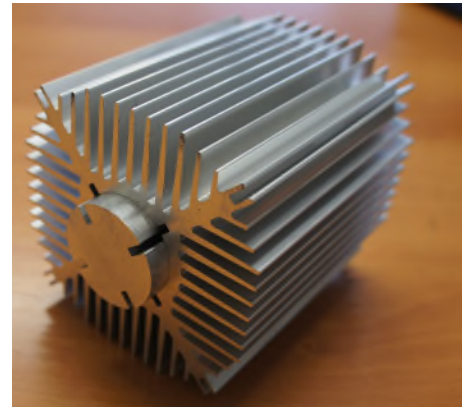
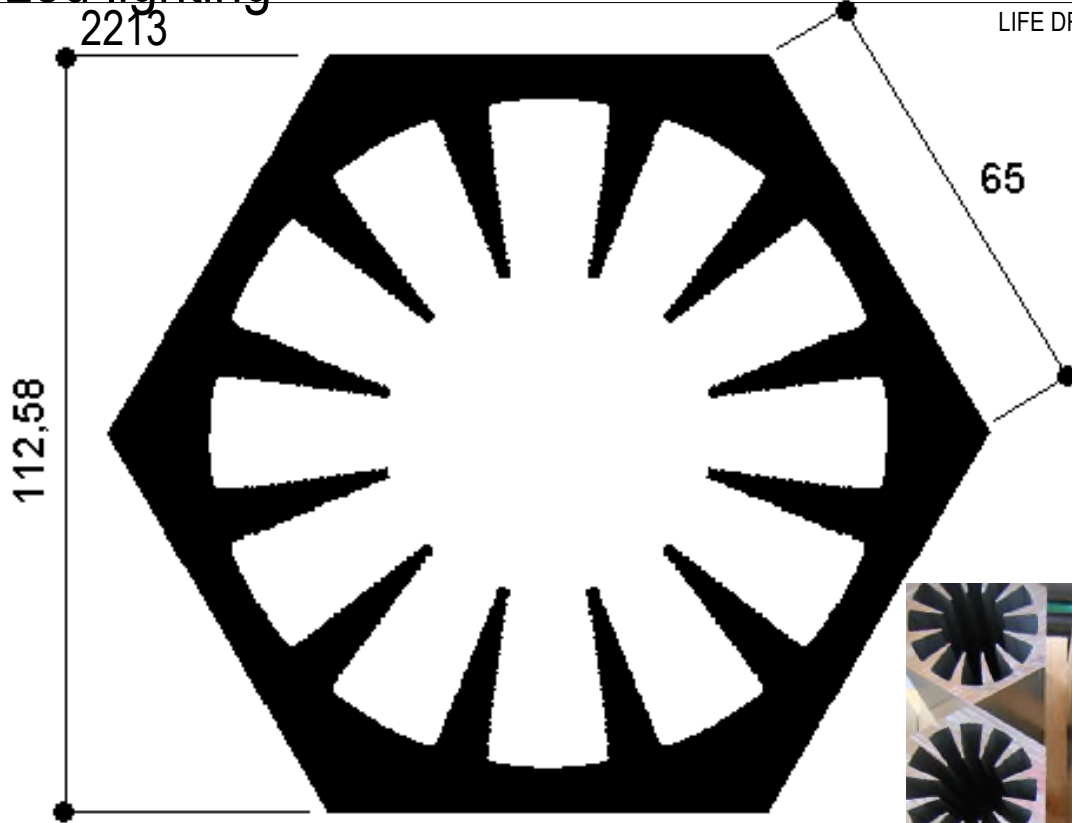

Cataloghi Online: www.omar-alluminio.it

www.omar-alluminio.com

CUSTOM ALUMINUM PROFILES / STANDARD / SPECIAL / AND FOR:

ELECTRONICS / LED / PHOTOVOLTAIC / ROBOTIC AUTOMATION / PNEUMATICS / AUTOMOTIVE

Via Newton, n.12

20016 Pero (Milano - Italy)

Tel. +39 02 3535955 r.a. Fax. +39 02 3539929

E-Mail: info@omar-alluminio.it



Aluminum heat sinks for Led lighting



OUT OF SCALE DRAWING

*PRIVATE PROFILE

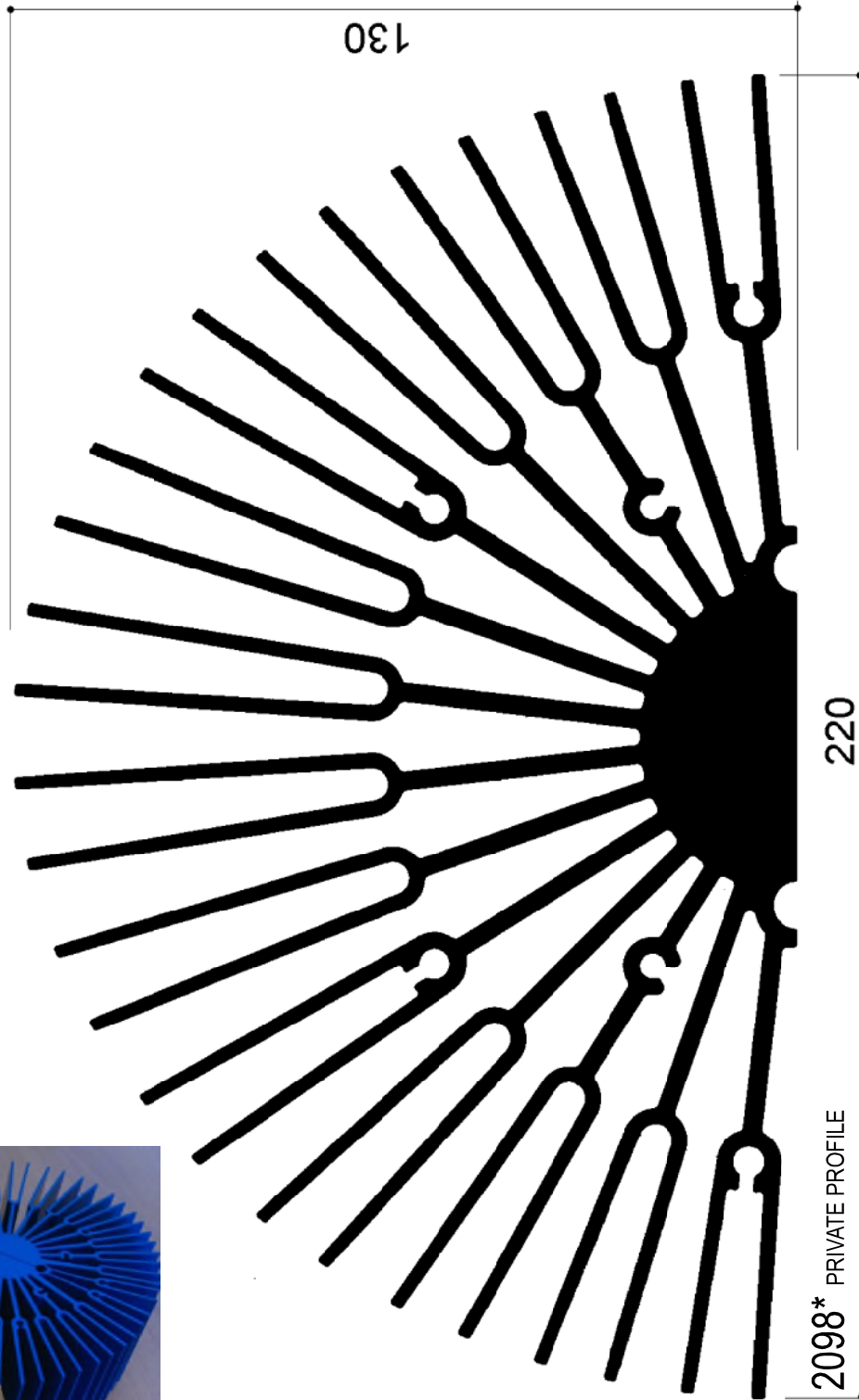

Cataloghi Online: www.omar-alluminio.it

www.omar-alluminio.com

CUSTOM ALUMINUM PROFILES / STANDARD / SPECIAL / AND FOR:

ELECTRONICS / LED / PHOTOVOLTAIC / ROBOTIC AUTOMATION / PNEUMATICS / AUTOMOTIVE

Via Newton, n.12

20016 Pero (Milano - Italy)

Tel. +39 02 3535955 r.a. Fax. +39 02 3539929

E-Mail: info@omar-alluminio.it



Round Aluminum Heat Sinks for Led Lighting



Via Newton, n.12
 20016 Pero (Milano - Italy)
 Tel. +39 02 3535955 r.a. Fax. +39 02 3539929
 E-Mail: info@omar-alluminio.it

Cataloghi Online: www.omar-alluminio.it

www.omar-alluminio.com

CUSTOM ALUMINUM PROFILES / STANDARD / SPECIAL / AND FOR:
 ELECTRONICS / LED / PHOTOVOLTAIC / ROBOTIC AUTOMATION / PNEUMATICS / AUTOMOTIVE

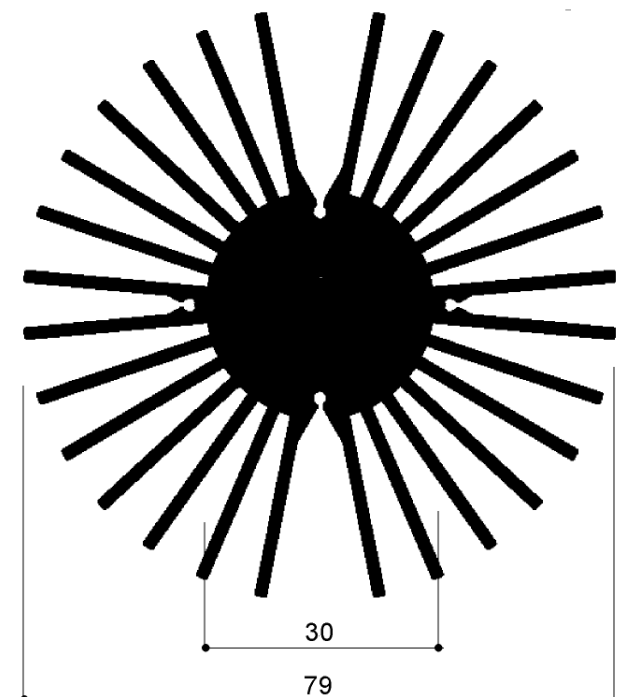
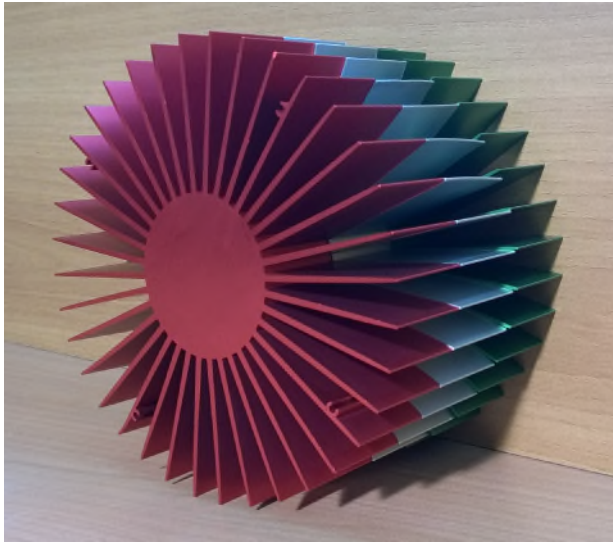
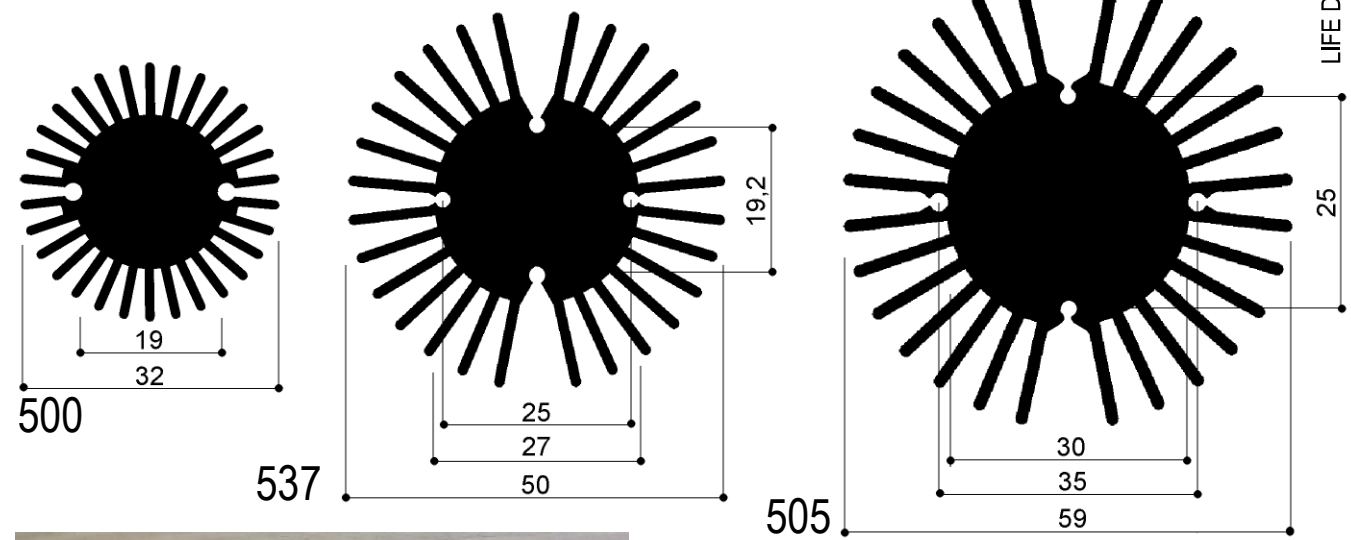
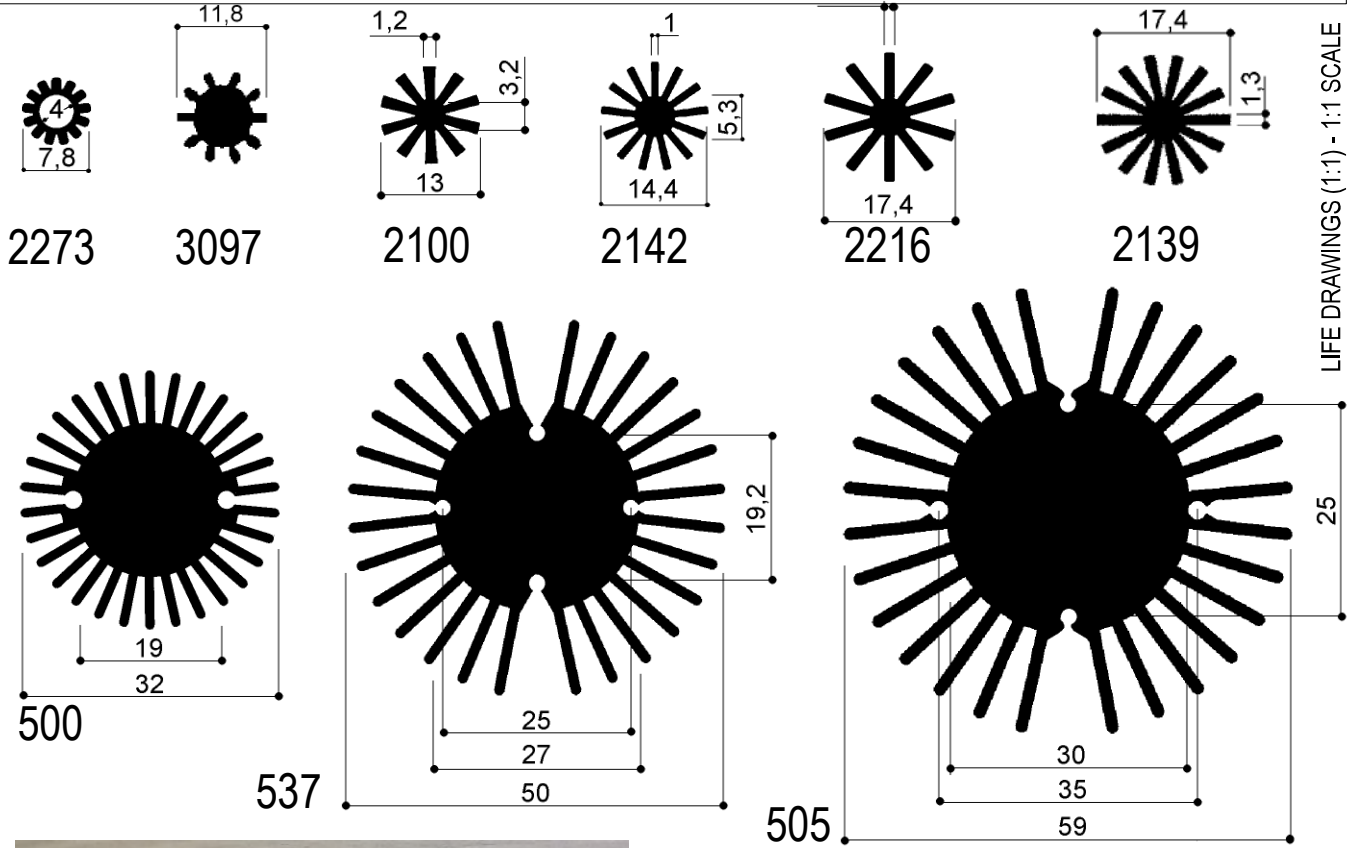

-REPRODUCTION PROHIBITED-
 CONTINUOUS UPDATE - ED. 12-2024

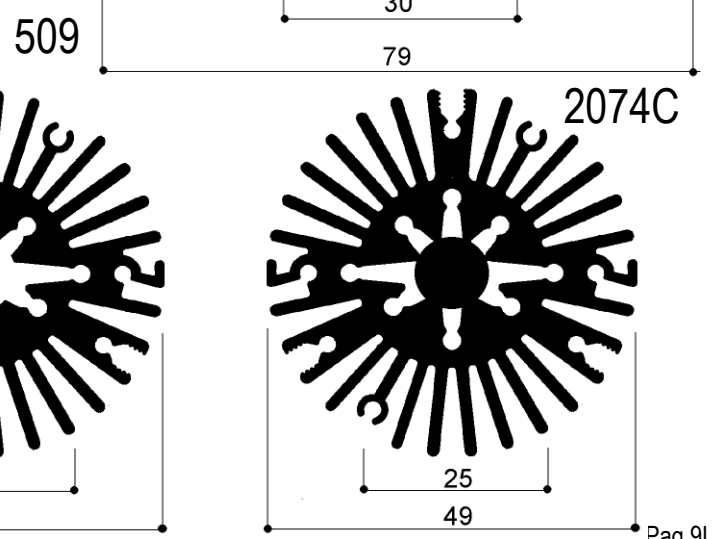
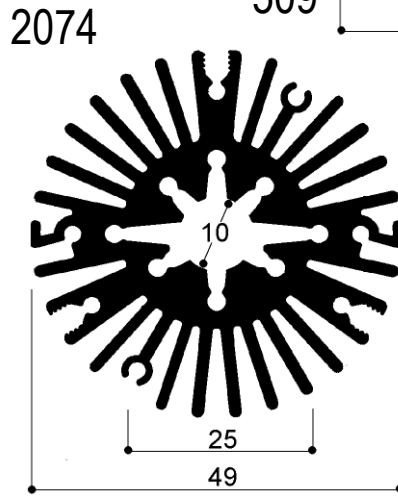
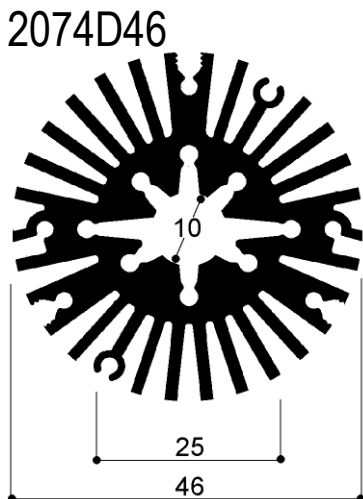

LIFE DRAWINGS (1:1) - 1:1 SCALE

Round Aluminum Heat Sinks for Led Lighting



LIFE DRAWINGS (1:1) - 1:1 SCALE

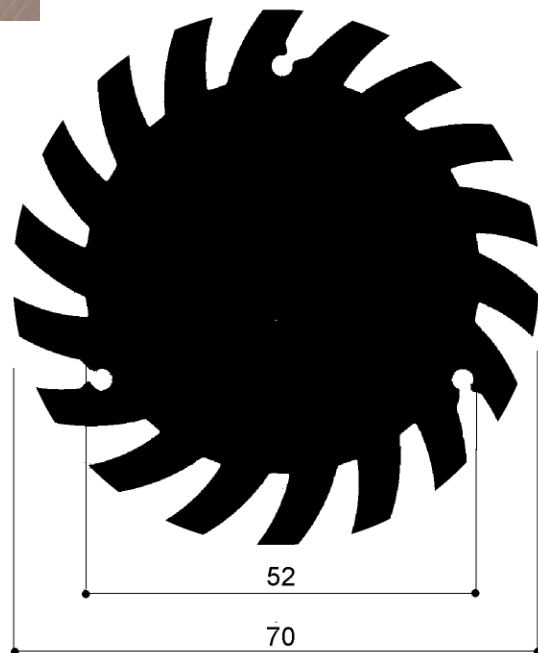
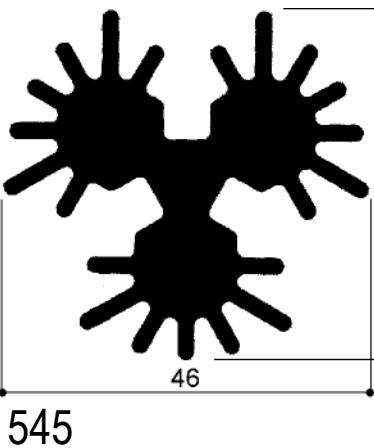
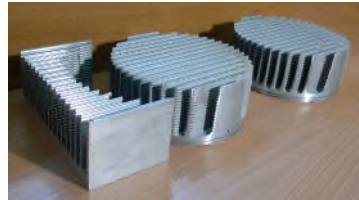
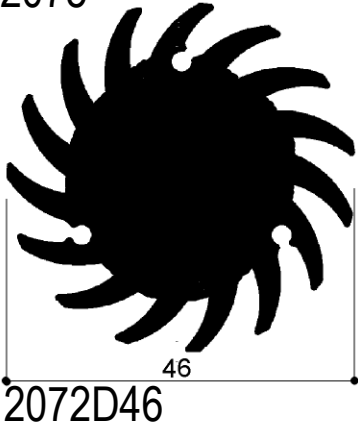
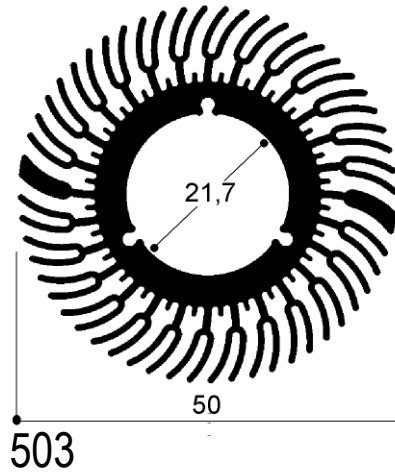
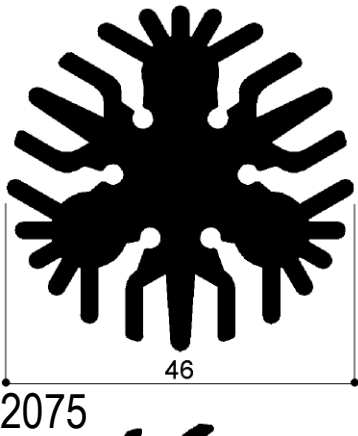
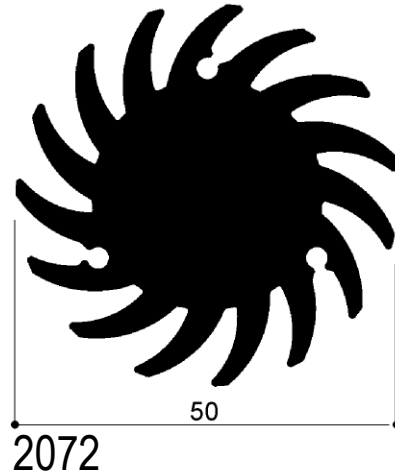
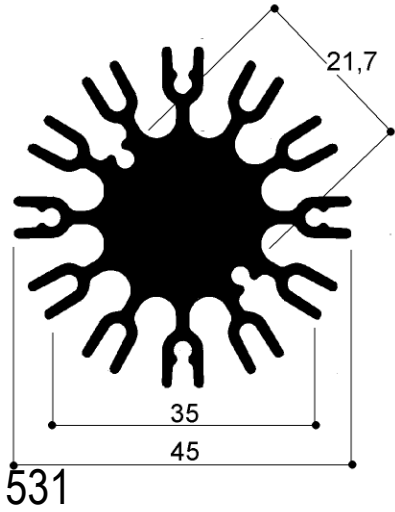

Cataloghi Online: www.omar-alluminio.it

www.omar-alluminio.com

CUSTOM ALUMINUM PROFILES / STANDARD / SPECIAL / AND FOR:

ELECTRONICS / LED / PHOTOVOLTAIC / ROBOTIC AUTOMATION / PNEUMATICS / AUTOMOTIVE

Via Newton, n.12

20016 Pero (Milano - Italy)

Tel. +39 02 3535955 r.a. Fax. +39 02 3539929

E.Mail: info@omar-alluminio.it



Round Aluminum Heat Sinks for Led Lighting



LIFE DRAWINGS (1:1) - SCALE 1:1

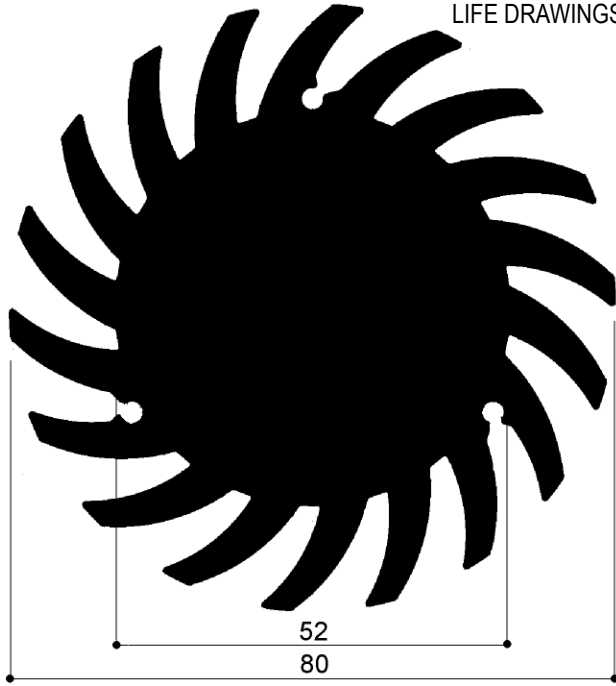

2073

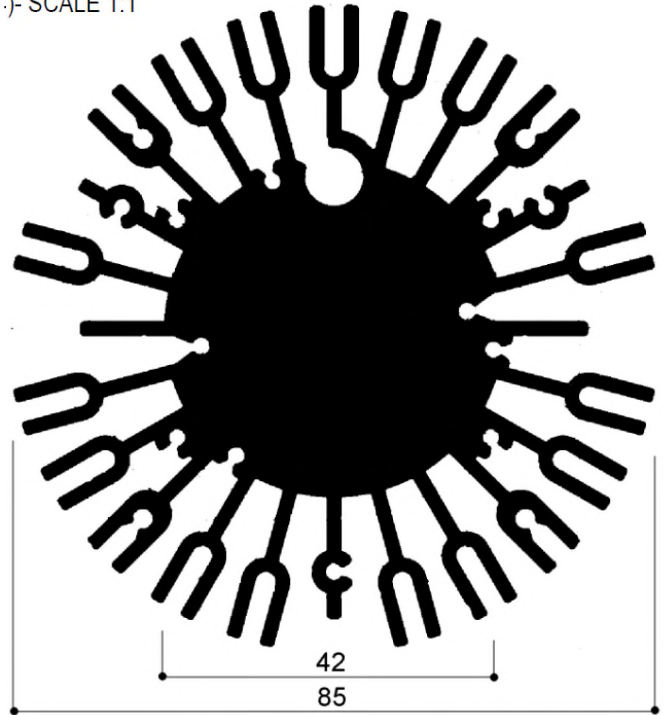

542

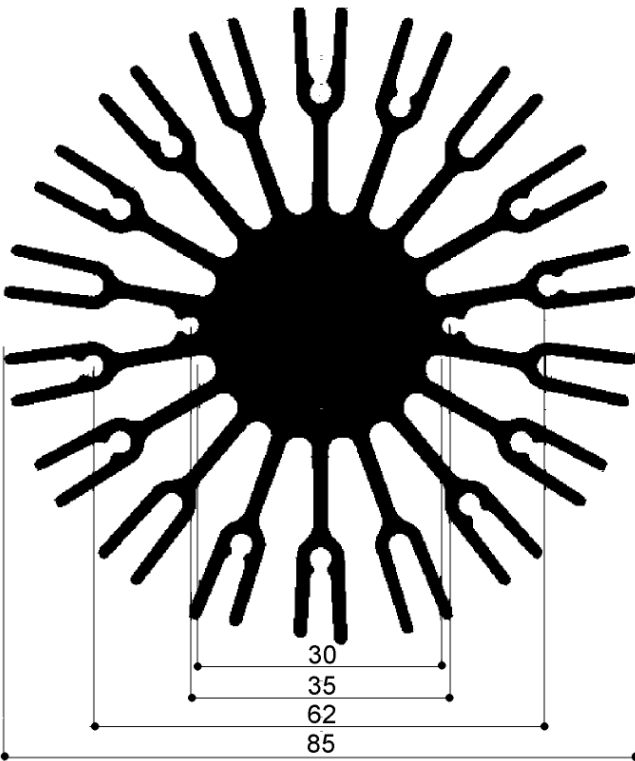

529

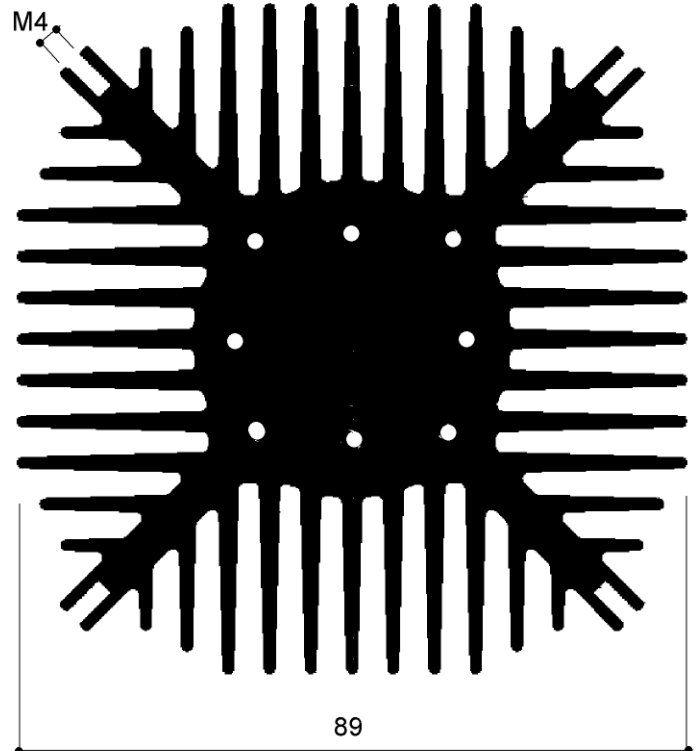

543

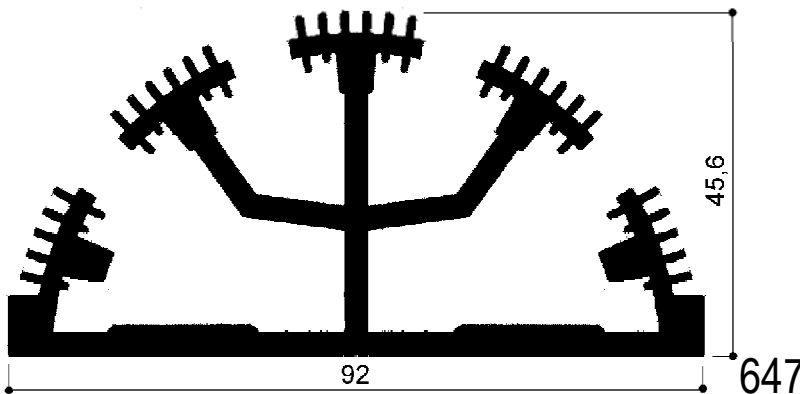

647



Via Newton, n.12

20016 Pero (Milano - Italy)

Tel. +39 02 3535955 r.a. Fax. +39 02 3539929

E-Mail: info@omar-alluminio.it

Cataloghi Online: www.omar-alluminio.it

www.omar-alluminio.com

CUSTOM ALUMINUM PROFILES / STANDARD / SPECIAL / AND FOR:

ELECTRONICS / LED / PHOTOVOLTAIC / ROBOTIC AUTOMATION / PNEUMATICS / AUTOMOTIVE



Round Aluminum Heat Sinks for Led Lighting



LIFE DRAWINGS (1:1) - 1:1 SCALE

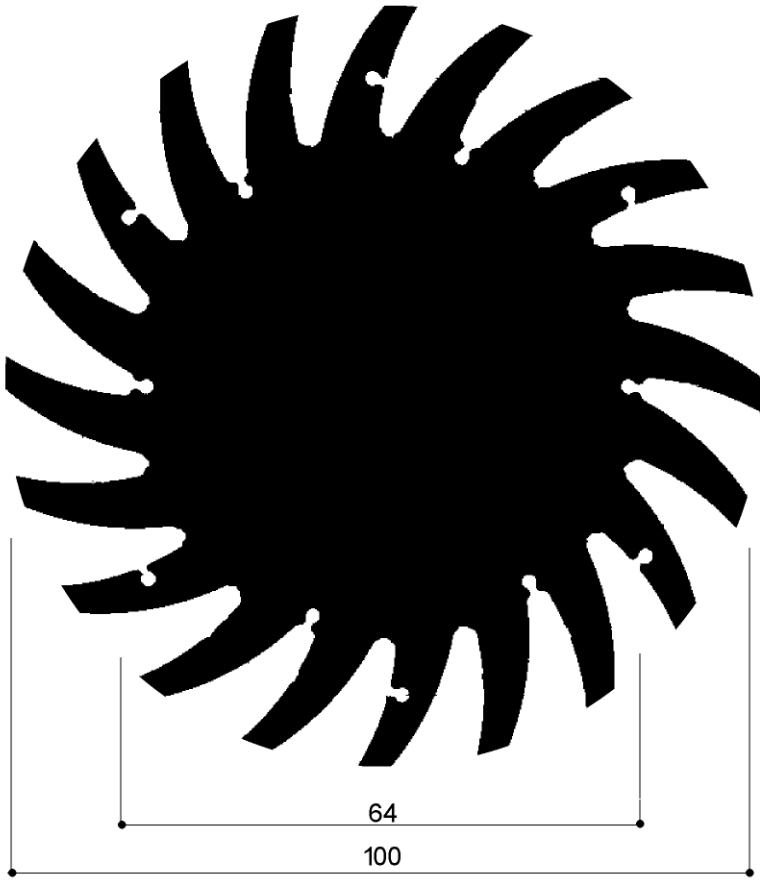

2076D100

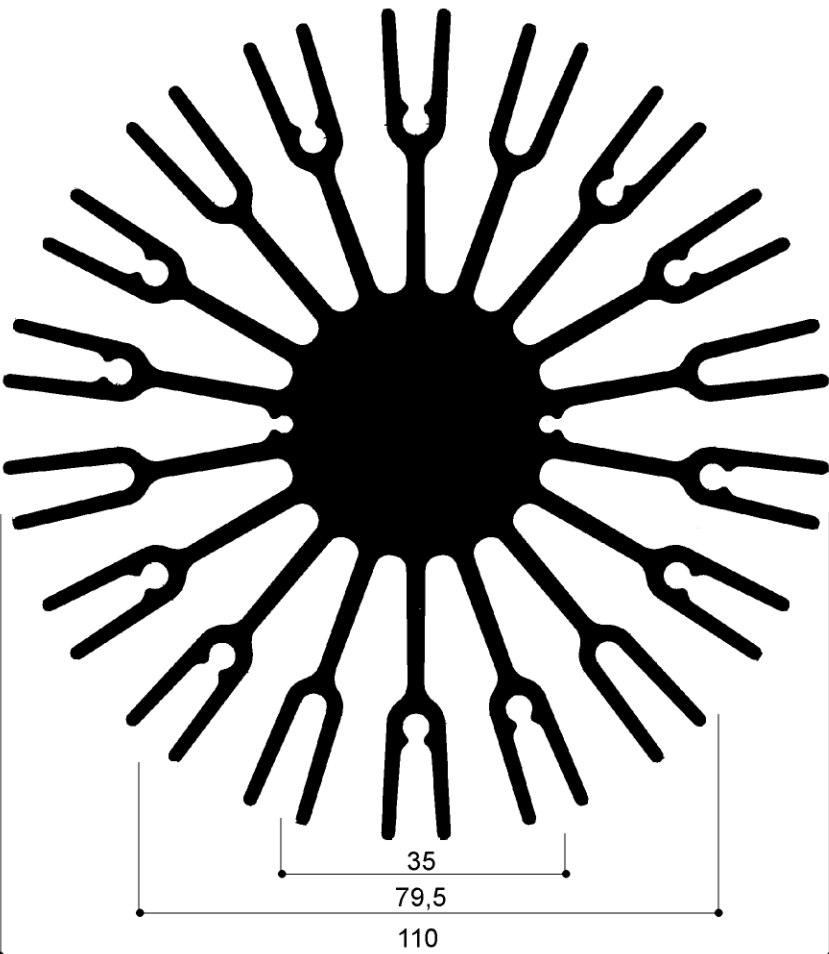

532

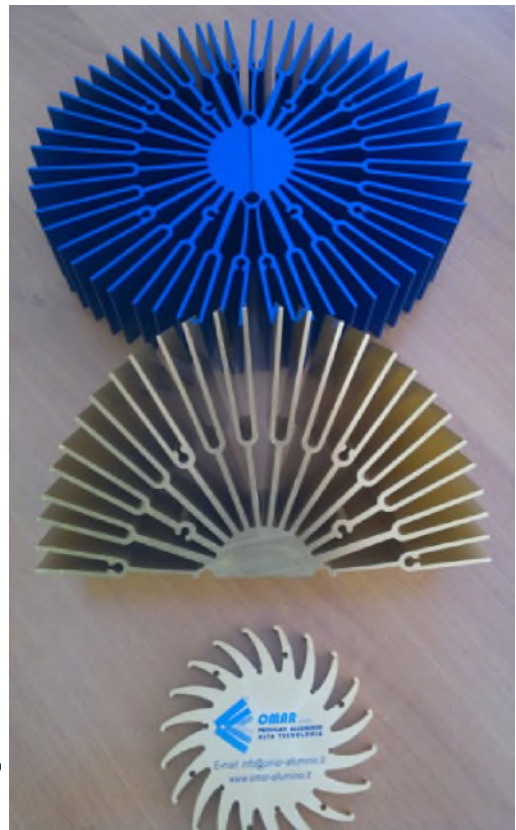

Cataloghi Online: www.omar-alluminio.it

www.omar-alluminio.com

CUSTOM ALUMINUM PROFILES / STANDARD / SPECIAL / AND FOR:

ELECTRONICS / LED / PHOTOVOLTAIC / ROBOTIC AUTOMATION / PNEUMATICS / AUTOMOTIVE



Via Newton, n.12

20016 Pero (Milano - Italy)

Tel. +39 02 3535955 r.a. Fax. +39 02 3539929

E.Mail: info@omar-alluminio.it

Round Aluminum Heat Sinks for Led Lighting



Via Newton, n.12
 20016 Pero (Milano - Italy)
 Tel.+39 02 3535955 r.a. Fax.+39 02 3539929
 E.Mail: info@omar-alluminio.it

Cataloghi Online: www.omar-alluminio.it
www.omar-alluminio.com

CUSTOM ALUMINUM PROFILES / STANDARD / SPECIAL / AND FOR:
 ELECTRONICS / LED / PHOTOVOLTAIC / ROBOTIC AUTOMATION / PNEUMATICS / AUTOMOTIVE

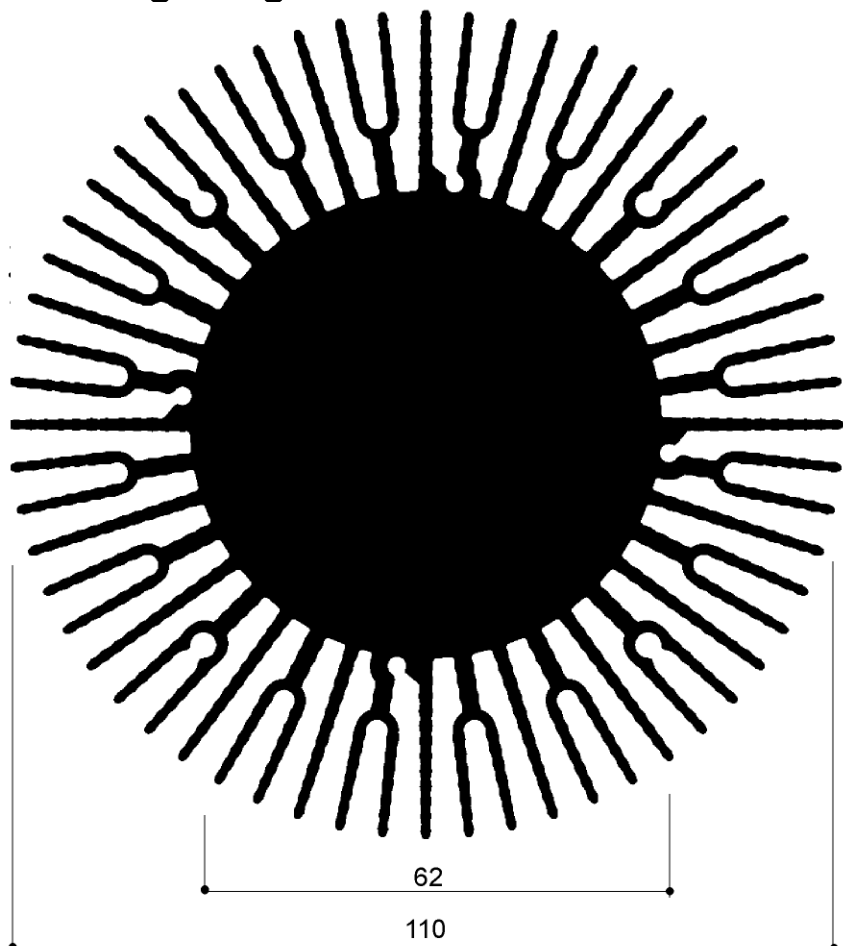

513

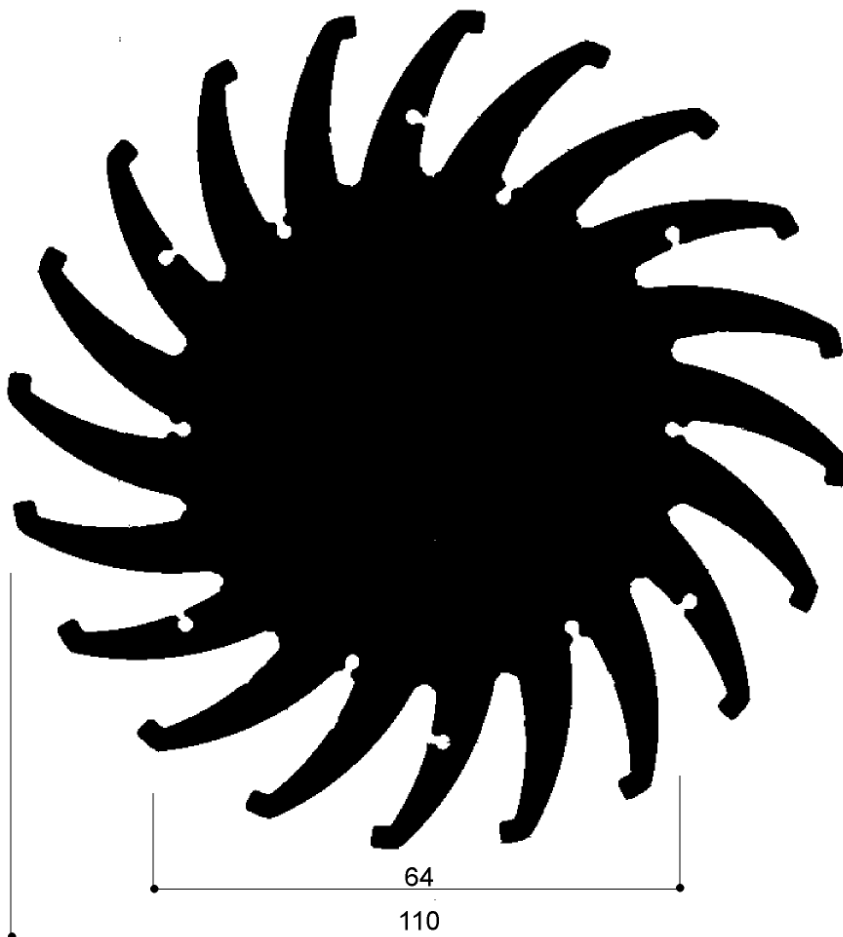

2076 CONTINUOUS UPDATE - E. OF 12-2024

REPRODUCTION PROHIBITED -



Aluminum heat sinks for Led lighting

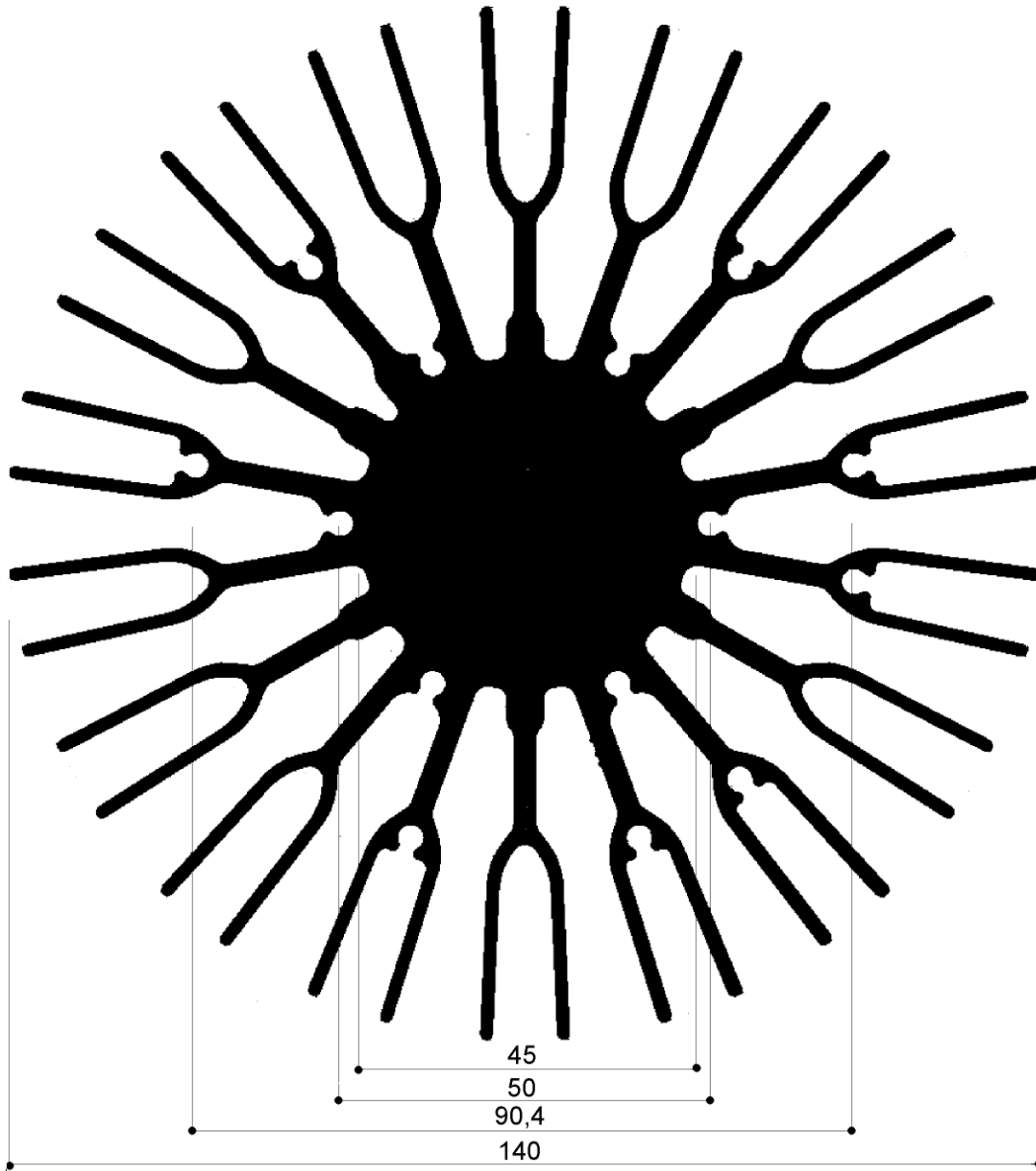

530

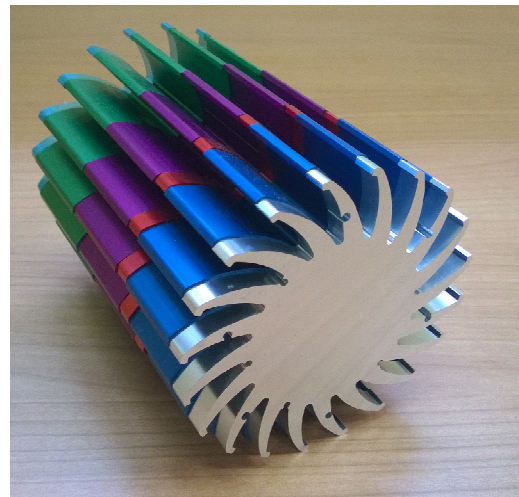
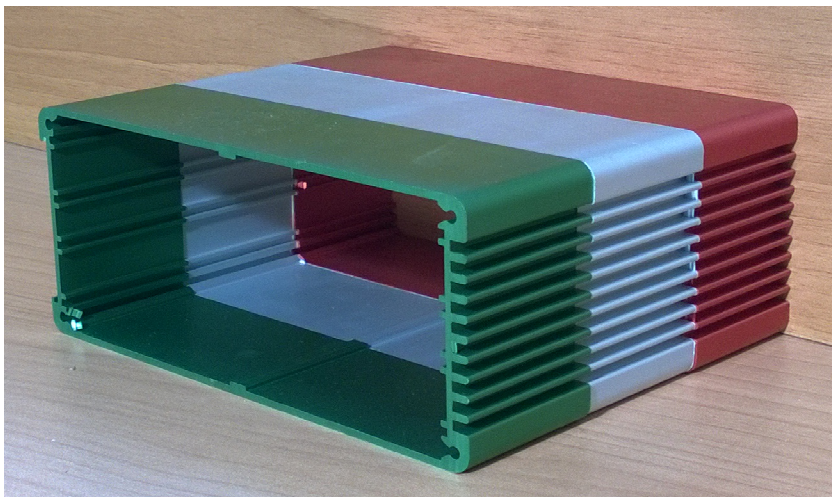

Cataloghi Online: www.omar-alluminio.it

www.omar-alluminio.com

CUSTOM ALUMINUM PROFILES / STANDARD / SPECIAL / AND FOR:

ELECTRONICS / LED / PHOTOVOLTAIC / ROBOTIC AUTOMATION / PNEUMATICS / AUTOMOTIVE

Via Newton, n.12

20016 Pero (Milano - Italy)

Tel. +39 02 3535955 r.a. Fax. +39 02 3539929

E.Mail: info@omar-alluminio.it



Aluminum heat sinks for Led lighting



Via Newton, n.12
20016 Pero (Milano - Italy)
Tel.+39 02 3535955 r.a. Fax.+39 02 3539929
E.Mail: info@omar-alluminio.it

Cataloghi Online: www.omar-alluminio.it
www.omar-alluminio.com

CUSTOM ALUMINUM PROFILES / STANDARD / SPECIAL / AND FOR:
ELECTRONICS / LED / PHOTOVOLTAIC / ROBOTIC AUTOMATION / PNEUMATICS / AUTOMOTIVE

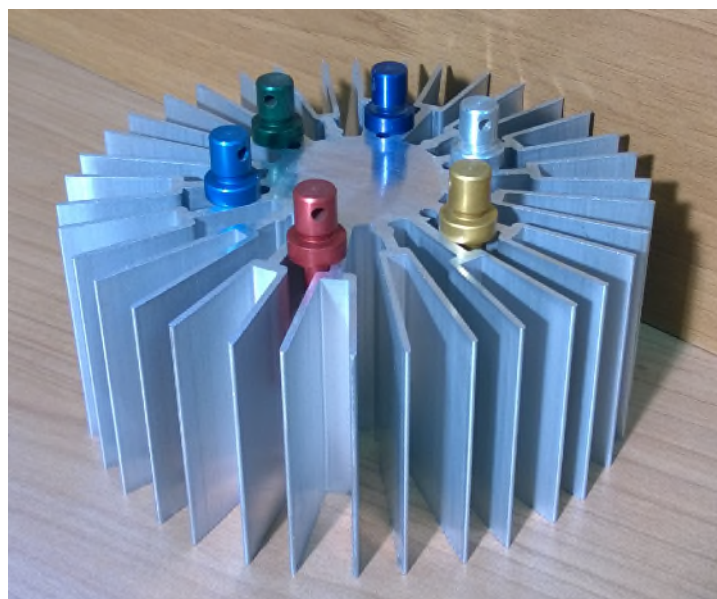
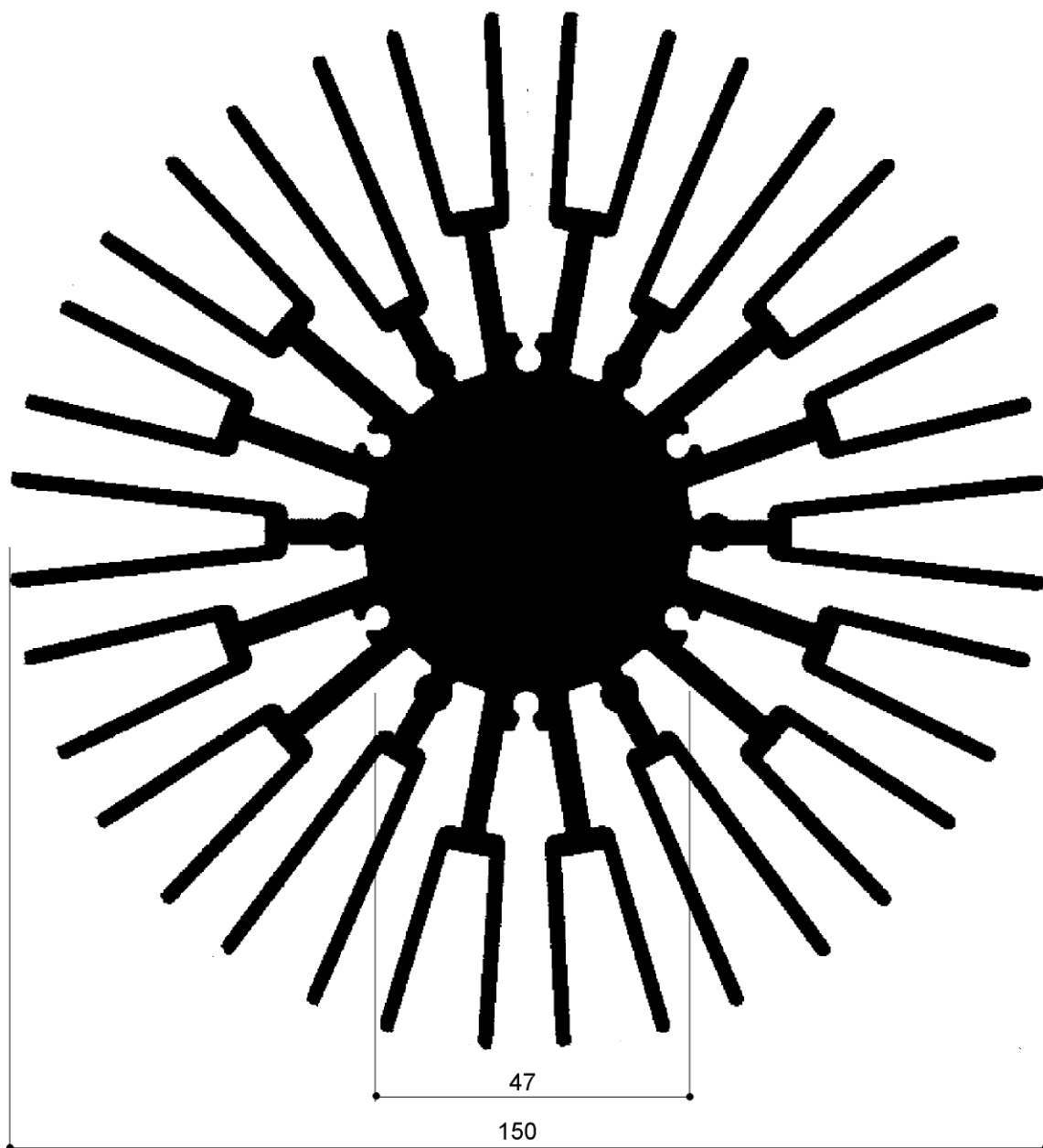

Aluminum heat sinks for Led lighting



LIFE DRAWINGS (1:1) - 1:1 SCALE

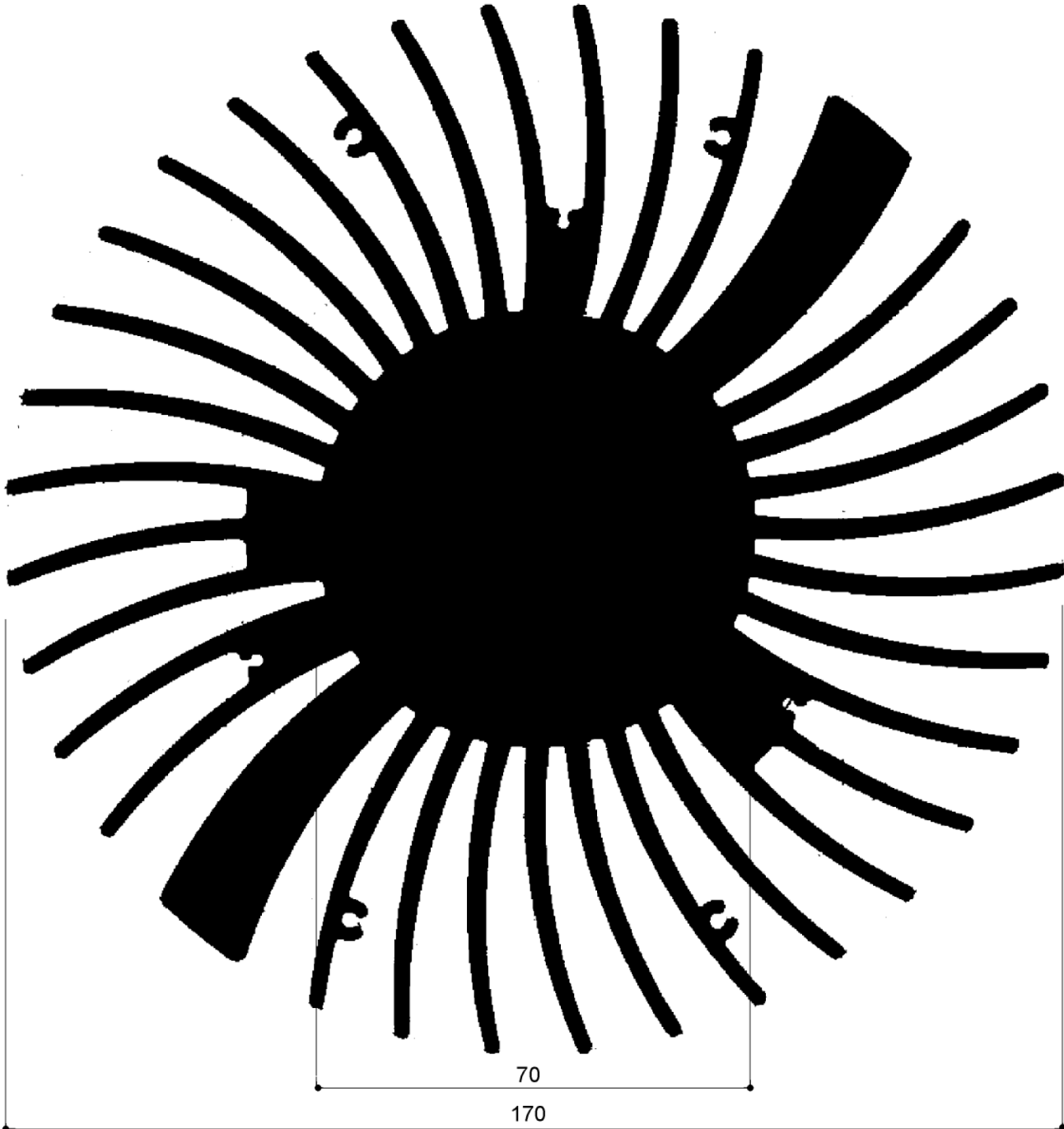

523

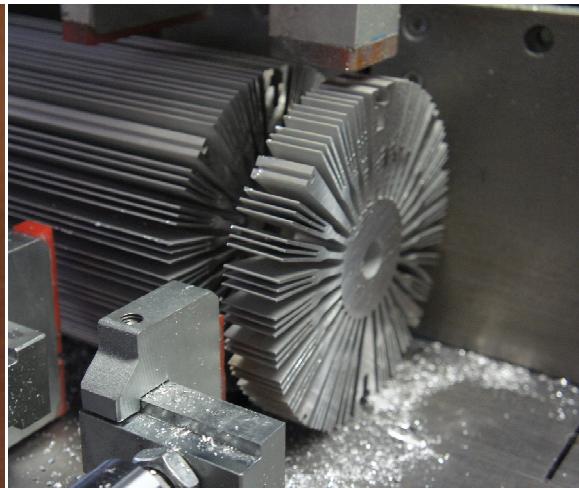
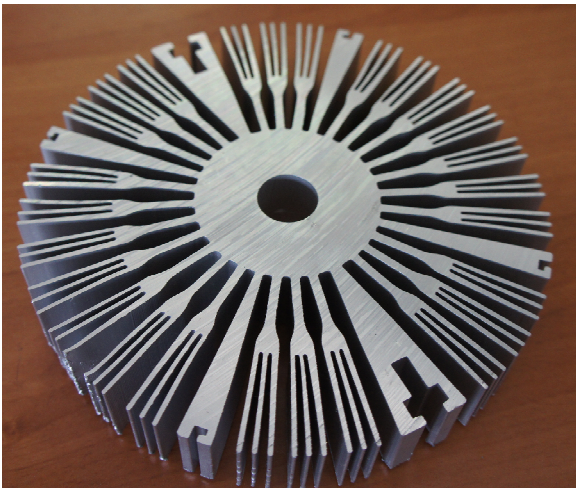

- REPRODUCTION PROHIBITED -
CONTINUOUS UPDATE - ED. 12-2024



Cataloghi Online: www.omar-alluminio.it

www.omar-alluminio.com

CUSTOM ALUMINUM PROFILES / STANDARD / SPECIAL / AND FOR:

ELECTRONICS / LED / PHOTOVOLTAIC / ROBOTIC AUTOMATION / PNEUMATICS / AUTOMOTIVE

Via Newton, n.12

20016 Pero (Milano - Italy)

Tel. +39 02 3535955 r.a. Fax. +39 02 3539929

E.Mail: info@omar-alluminio.it

Aluminum heat sinks for Led lighting

Extruded aluminum heat sinks alloy 6060T5 ready in stock in the basic version:
-only round milling with various diameters -raw



LIFE DRAWINGS (1:1) - 1:1 SCALE

ASSEMBLED PROFILE: DIAGRAM

544

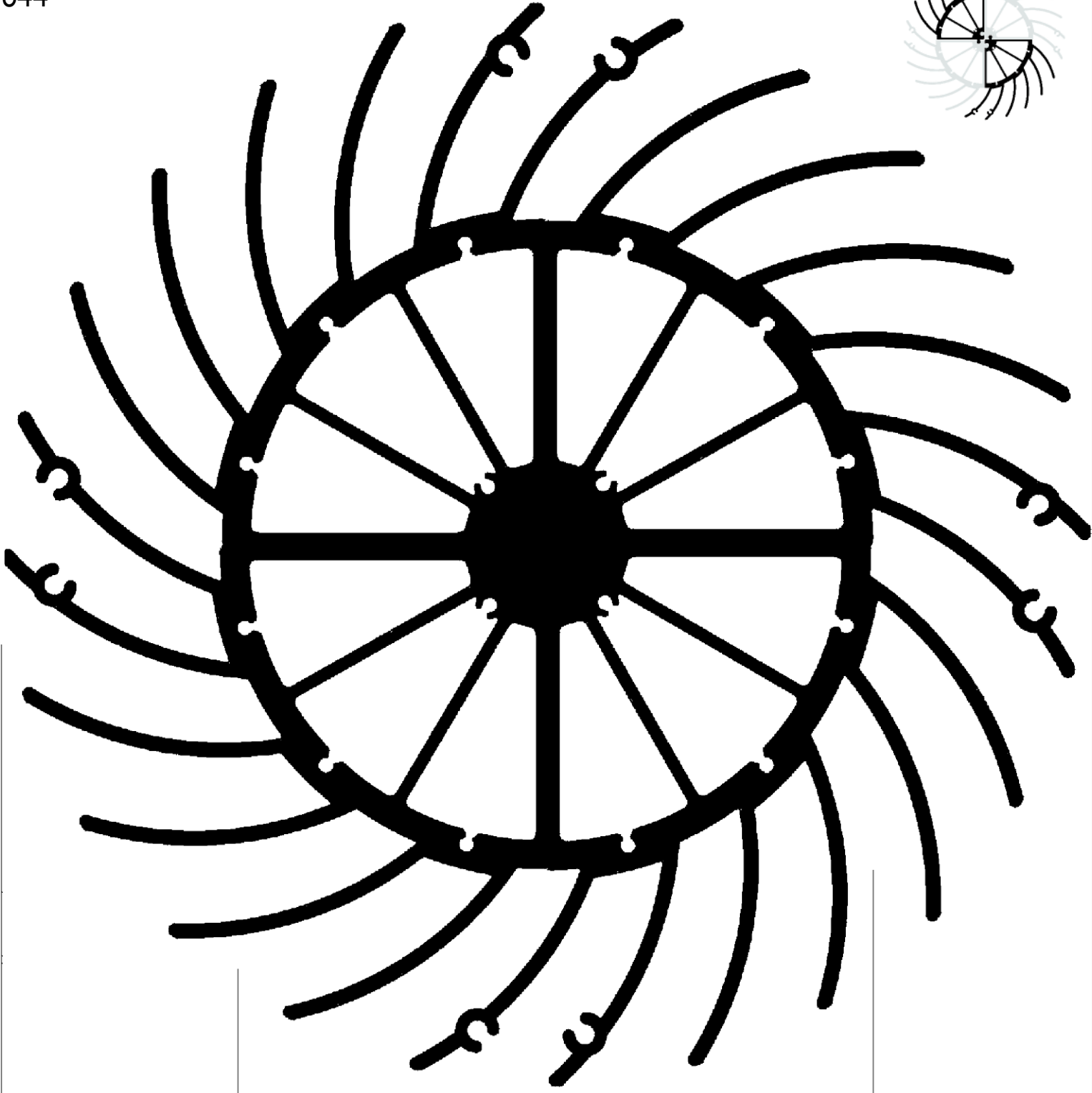
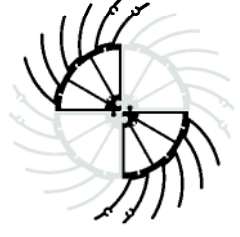

124
200



Via Newton, n.12
20016 Pero (Milano - Italy)
Tel.+39 02 3535955 r.a. Fax.+39 02 3539929
E.Mail: info@omar-alluminio.it

Aluminum heat sinks for Led lighting

Extruded aluminum heat sinks alloy 6060T5 ready in stock in the basic version:
-only round milling with various diameters -raw



LIFE DRAWINGS (1:1) - 1:1 SCALE

524

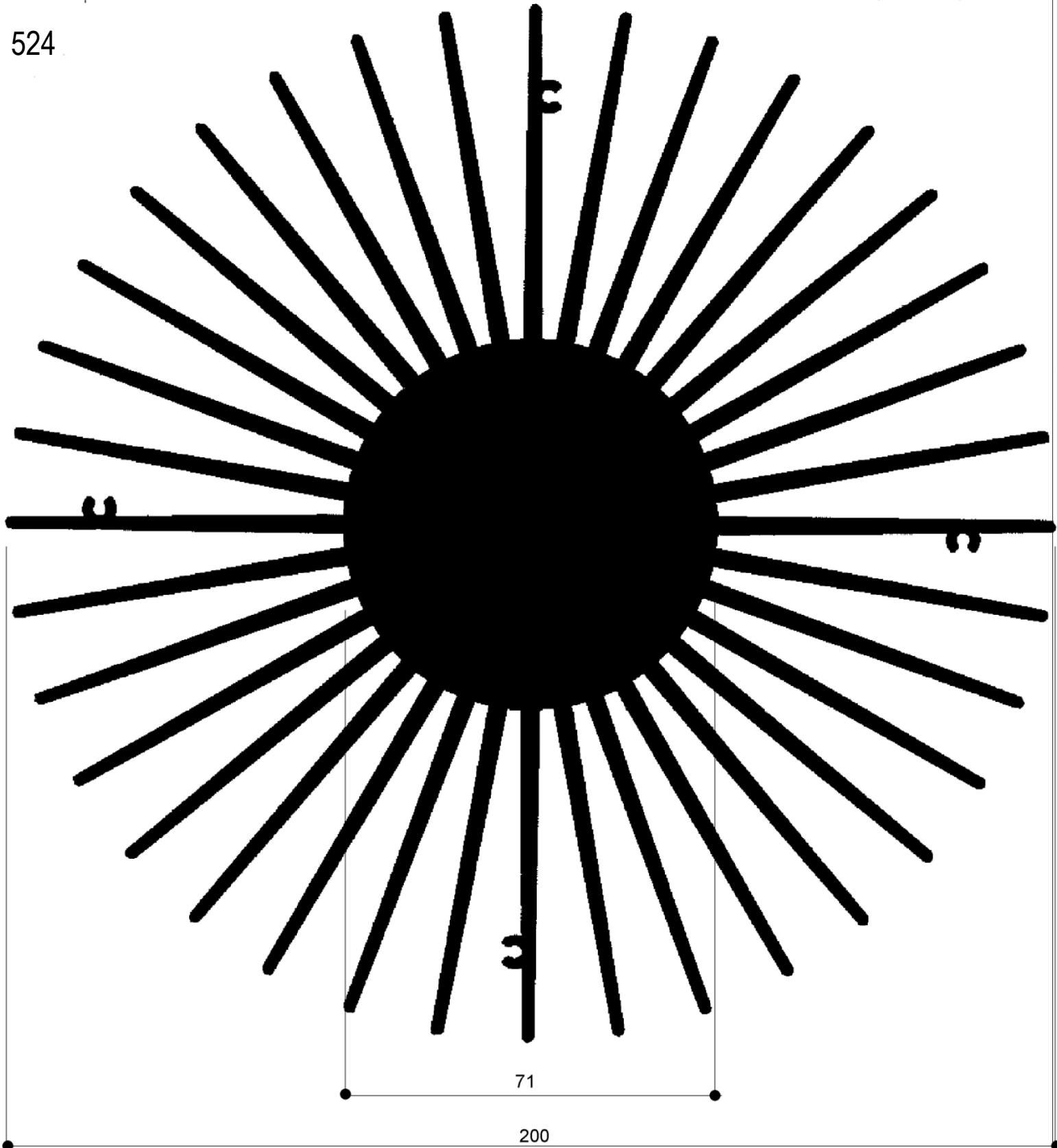

Via Newton, n.12
20016 Pero (Milano - Italy)
Tel.+39 02 3535955 r.a. Fax.+39 02 3539929
E.Mail: info@omar-alluminio.it

Aluminum heat sinks for Led lighting



REAL LIFE DRAWINGS 1:1 SCALE

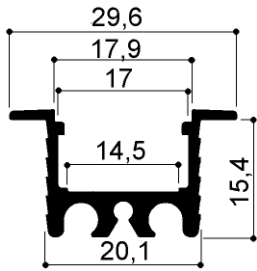

526

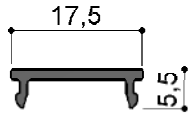

COV526

EXAMPLE PROFILES ASSEMBLED COVER

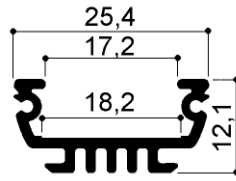
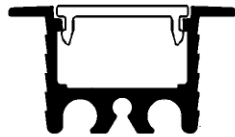

527

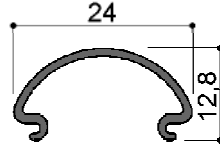

COV527

EXAMPLE PROFILES ASSEMBLED

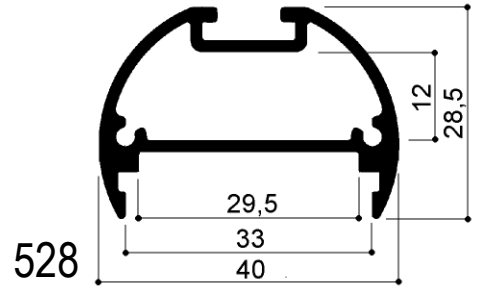
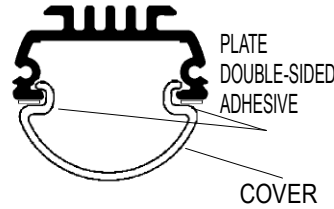

528

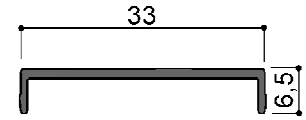

COV528

EXAMPLE PROFILES ASSEMBLED

PLATE DOUBLE-SIDED ADHESIVE

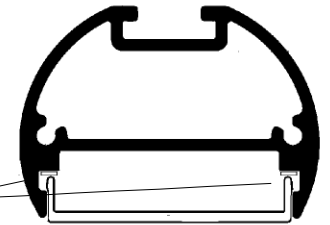

COVER

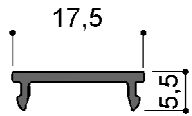

COV526 polycarbonate cover self-extinguishing

- COV526-PT: transparent cover
- COV526-PO: opal cover
- COV526-PST: transparent satin cover
- COV526-PSO: opal satin cover

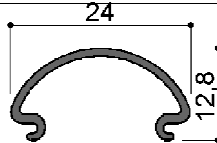

COV527 polycarbonate cover self-extinguishing

- COV527-PT: transparent cover
- COV527-PO: opal cover
- COV527-PST: transparent satin cover
- COV527-PSO: opal satin cover

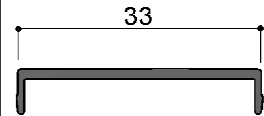

COV528

polycarbonate cover self-extinguishing

- COV528-PT: transparent cover
- COV528-PO: opal cover
- COV528-PST: transparent satin cover
- COV528-PSO: opal satin cover
- COV528-PTMIC: transparent microprismatic

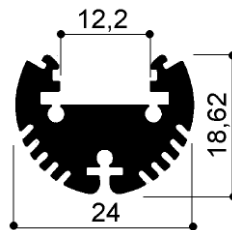

533

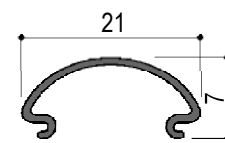

COV533 cover in polycarbonate self-extinguishing



533

COV533-PO: cover opale

COV533

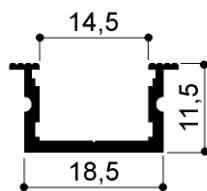

534

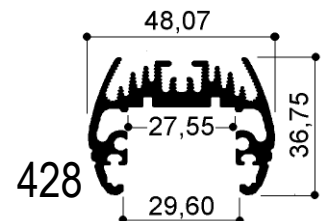

428



Aluminum profiles for LED STRIPS



ABS CLOSED CAP SILVER COLOR FOR ART.526 ART.CODE: L-0001



CAP WITH CABLE GLAND HOLE IN ABS SILVER COLOR FOR ART.526 COD.ART.L-0002



ABS CLOSED CAP SILVER COLOR FOR ART.527 ART.CODE: L-0006



CAP WITH CABLE GLAND HOLE IN ABS SILVER COLOR FOR ART.527 ART.CODE: L-0007



ABS FIXING BRACKET SILVER COLOR ART.527 ART.CODE: L-0008



ADJUSTABLE ROTATING FIXING BRACKET IN ABS SILVER COLOR ART.527 ART.CODE: L-0014



ABS CLOSED CAP SILVER COLOR FOR ART.528 ART.CODE:L-0010



CAP WITH CABLE GLAND HOLE IN ABS SILVER COLOR FOR ART.528 ART.CODE: L-0010



BRACKET KIT FOR WALL MOUNTING/SUSPENSION COLOR BLACK FOR ART.528 ART.CODE: L-0013



CABLE PASS ART.CODE: L-0012



SELF-TAPPING SCREWS 2.9X9.5 FOR FIXING CAP TO THE FM526 AND FM528 PROFILE
PACKS OF 100PCS ITEM CODE: L-0005

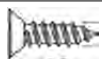

SELF-TAPPING SCREWS 2x6 FOR FIXING CAP TO PROFILE FM527
PACKS OF 100PCS ITEM CODE: L-0009



CLOSED CAP IN SILVER ANODIZED ALUMINUM FOR ART.533 ART.CODE:L-0015

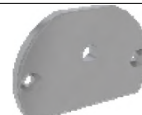

CAP WITH CABLE GLAND HOLE IN SILVER ANODIZED ALUMINUM FOR ART.528 ART.CODE: L-0016

Cataloghi Online: www.omar-alluminio.it

www.omar-alluminio.com

CUSTOM ALUMINUM PROFILES / STANDARD / SPECIAL / AND FOR:

ELECTRONICS / LED / PHOTOVOLTAIC / ROBOTIC AUTOMATION / PNEUMATICS / AUTOMOTIVE

Via Newton, n. 12

20016 Pero (Milano - Italy)

Tel. +39 02 3535955 r.a. Fax. +39 02 35339929

E-Mail: info@omar-alluminio.it



Aluminum profiles for LED STRIPS ACCESSORIES

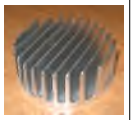

LIFE DRAWINGS (1:1) - 1:1 SCALE

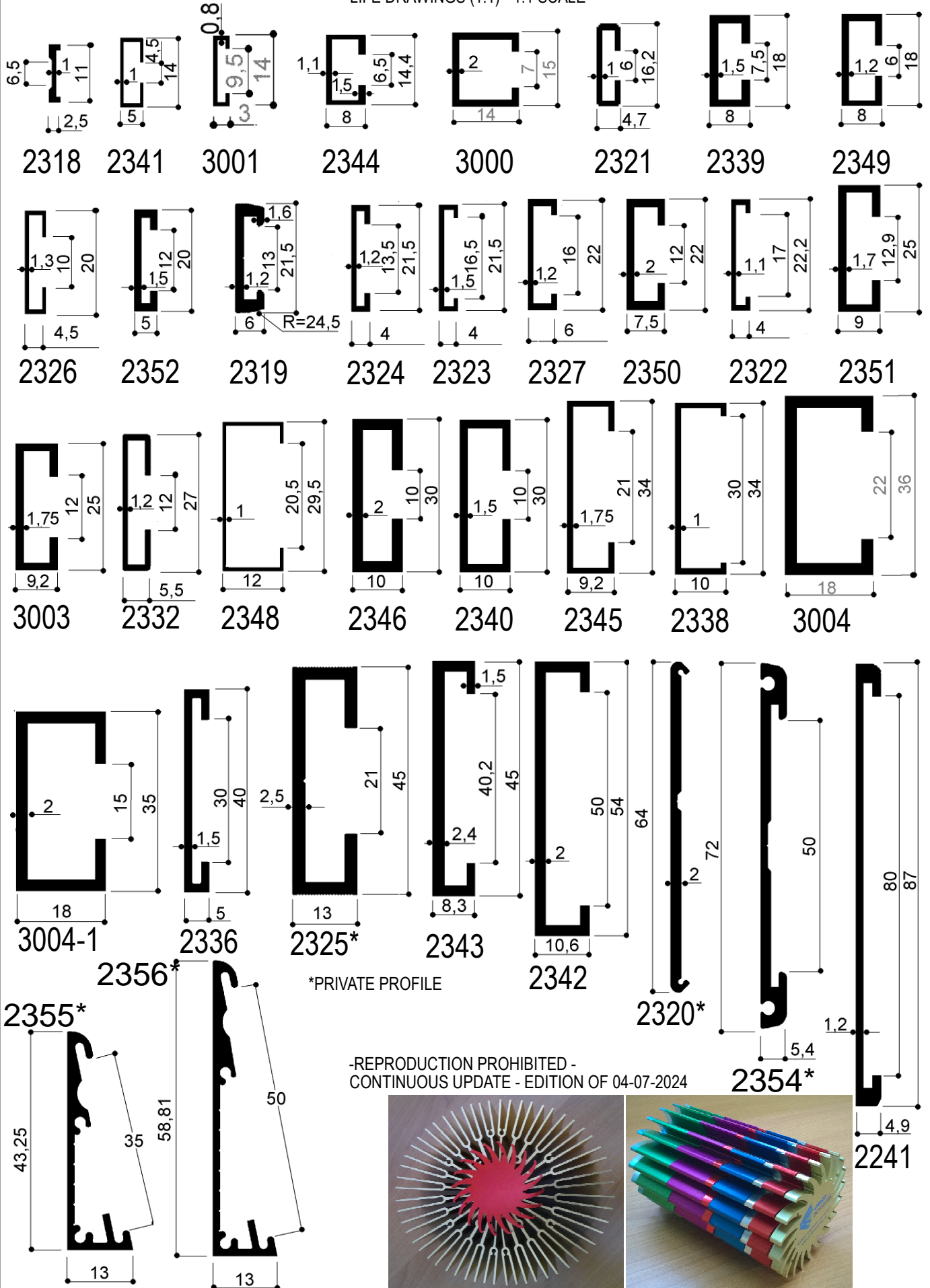

-REPRODUCTION PROHIBITED -
CONTINUOUS UPDATE - EDITION OF 04-07-2024

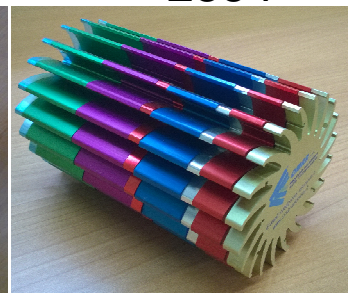
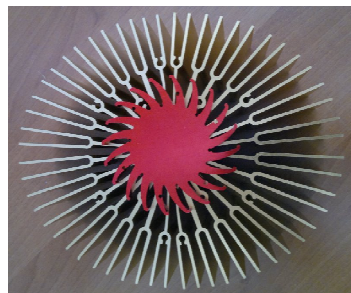

Via Newton, n.12

20016 Pero (Milano - Italy)

Tel. +39 02 3535955 r.a. Fax. +39 02 3539929

E-Mail: info@omar-alluminio.it

Cataloghi Online: www.omar-alluminio.it

www.omar-alluminio.com

CUSTOM ALUMINUM PROFILES / STANDARD / SPECIAL / AND FOR:
ELECTRONICS / LED / PHOTOVOLTAIC / ROBOTIC AUTOMATION / PNEUMATICS / AUTOMOTIVE

OMAR s.r.l.
PROFILATI ALLUMINIO
ALTA TECNOLOGIA

Aluminum heat sinks for Led lighting

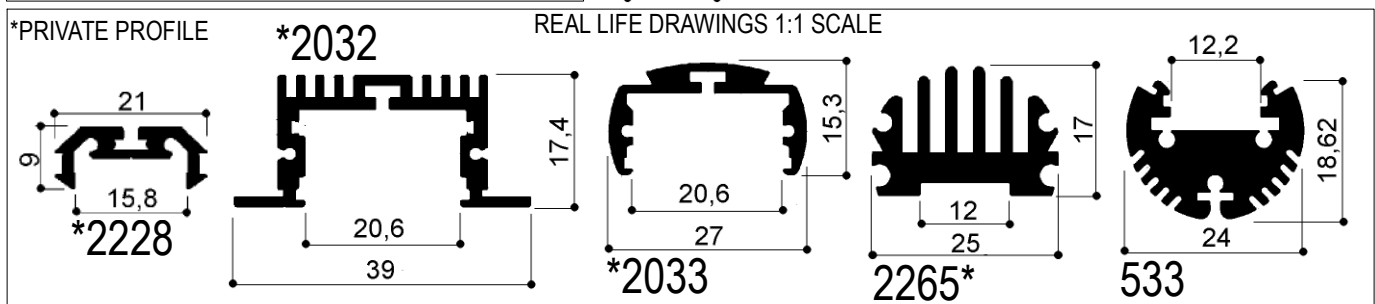
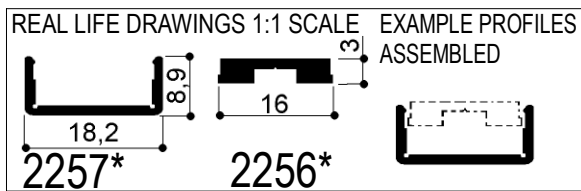
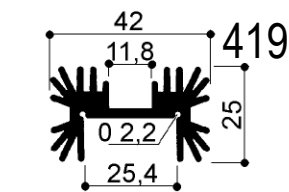
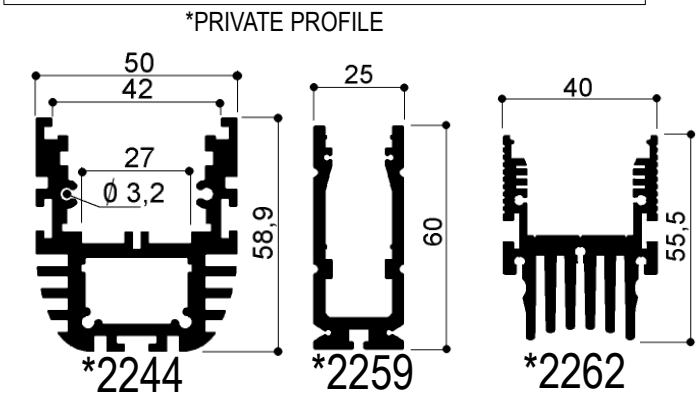
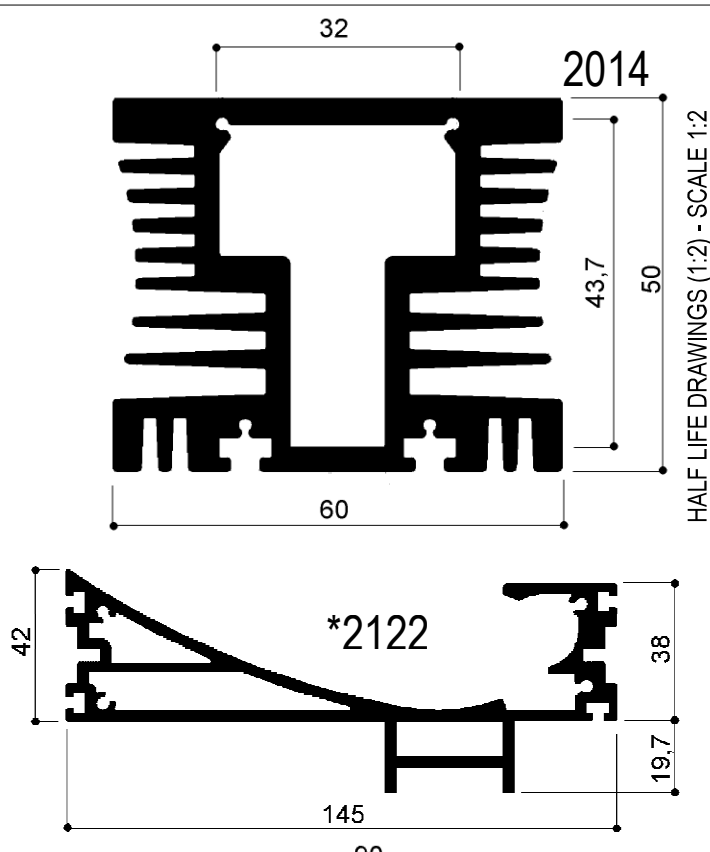
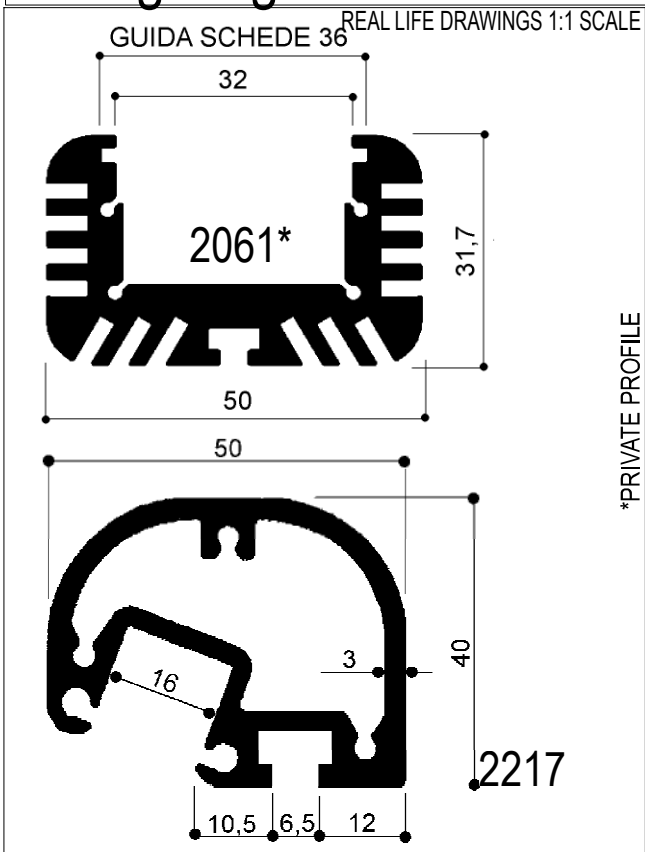

Cataloghi Online: www.omar-alluminio.it

www.omar-alluminio.com

CUSTOM ALUMINUM PROFILES / STANDARD / SPECIAL / AND FOR:

ELECTRONICS / LED / PHOTOVOLTAIC / ROBOTIC AUTOMATION / PNEUMATICS / AUTOMOTIVE

Via Newton, n.12

20016 Pero (Milano - Italy)

Tel. +39 02 3535955 r.a. Fax. +39 02 35339929

E-Mail: info@omar-alluminio.it



Heat sinks for LED light sources

Solid State Lighting - LED

We make heat sinks of any diameter starting from finned bars ready in stock
All the electronic profiles in the catalogue can be worked as in the examples below:

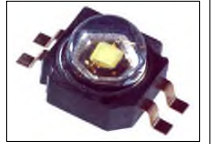

Via Newton, n.12
 20016 Pero (Milano - Italy)
 Tel.+39 02 3535955 r.a. Fax.+39 02 3539929
 E-Mail: info@omar-aluminio.it

Cataloghi Online: www.omar-aluminio.it
www.omar-aluminio.com

CUSTOM ALUMINIUM PROFILES / STANDARD / SPECIAL / AND FOR:
 ELECTRONICS / LED / PHOTOVOLTAIC / ROBOTIC AUTOMATION / PNEUMATICS / AUTOMOTIVE

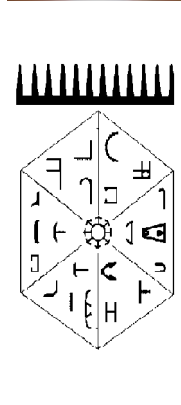
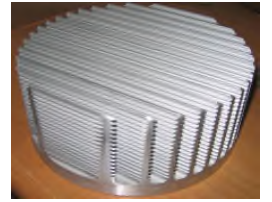
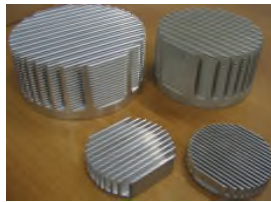
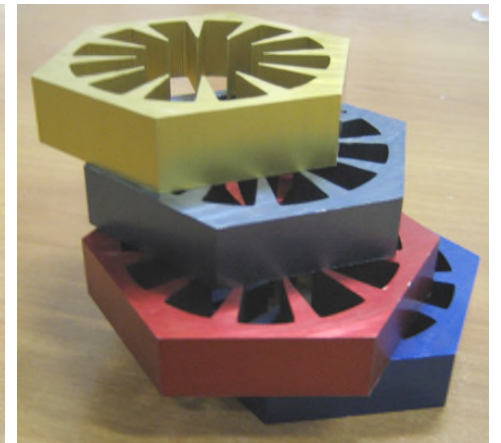
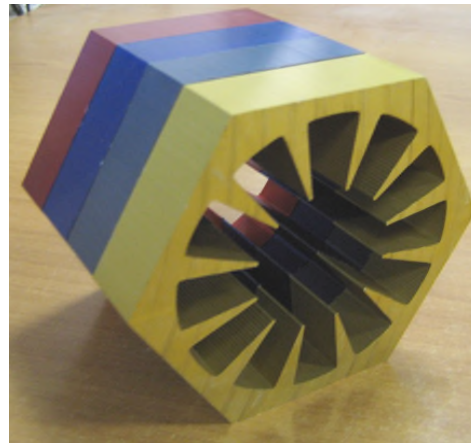
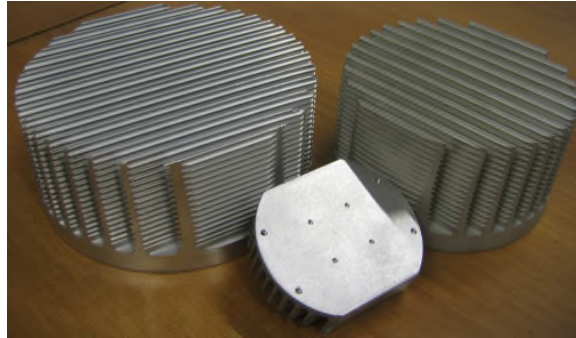
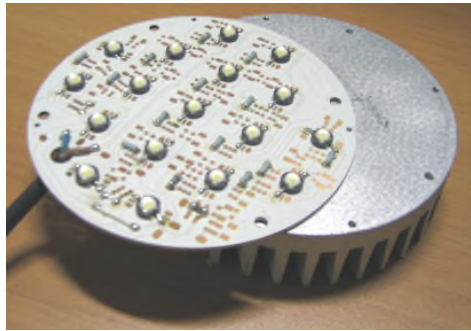

IN ADDITION TO THE PROFILES SHOWN IN THE CATALOGUE
 READY IN STOCK, WE ARE ABLE TO SUPPLY HEAT SINKS
 IN BARS WITH CUSTOM SHAPES EVEN FOR SMALL
 QUANTITIES. ALL PROFILES ARE AVAILABLE IN THE
 FOLLOWING FORMATS:
 - 3/4 METER BARS
 - CUT TO SIZE (RAW/OXIDIZED)
 - COMPLETELY PROCESSED ACCORDING TO YOUR DRAWING
 WE ARE ABLE TO SUPPLY:
 - CUSTOM SECTIONS ALSO FOR LITTLE QUANTITY
 - CUSTOM DRILLINGS



Aluminum heat sinks for Led lighting

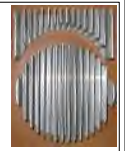

Round milled comb heat sinks for LEDs
-only round milling with various diameters -raw

HALF LIFE DRAWINGS (1:2) - SCALE 1:2

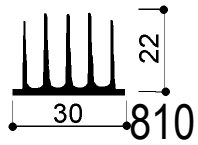

BAR MILLING
DIAMETRO: 27/30mm

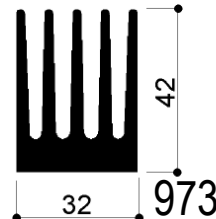
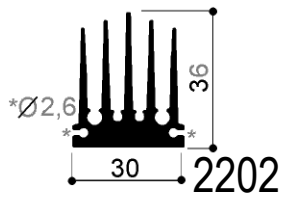

BAR MILLING
DIAMETRO: da 27mm a 32mm

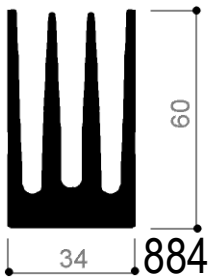
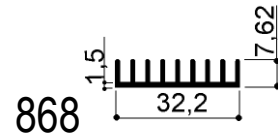

BAR MILLING
DIAMETRO: 34mm

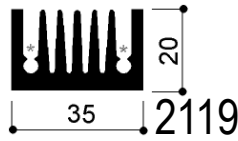

BAR MILLING
DIAMETRO: 27/30/32/35mm

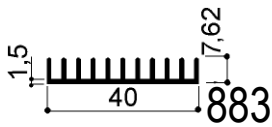
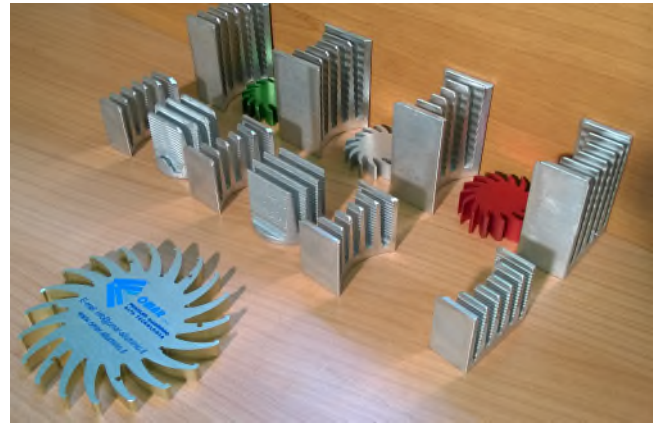

BAR MILLING
DIAMETRO: da 27 a 41/42mm

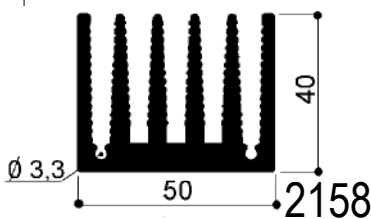
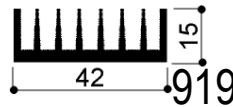
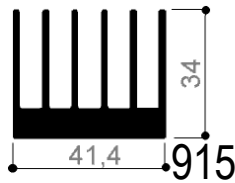

BAR MILLING
DIAMETRO: da 27mm a 50/52mm

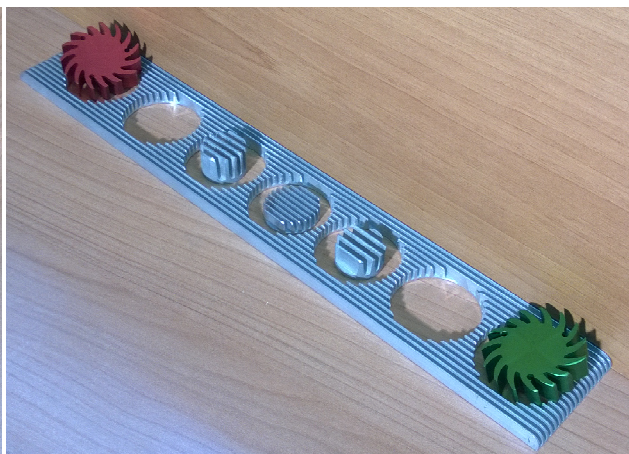
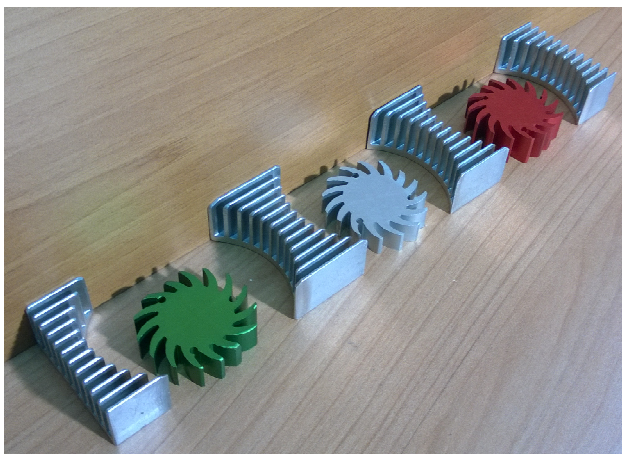
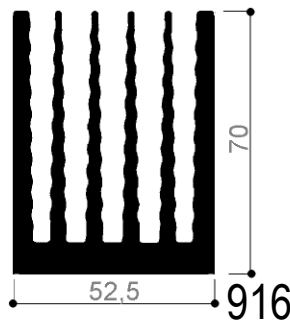
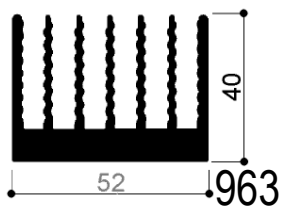

Via Newton, n. 12

20016 Pero (Milano - Italy)

Tel. +39 02 3535955 r.a. Fax. +39 02 3539929

E.Mail: info@omar-alluminio.it

Cataloghi Online: www.omar-alluminio.it

www.omar-alluminio.com

CUSTOM ALUMINUM PROFILES / STANDARD / SPECIAL / AND FOR:
ELECTRONICS / LED / PHOTOVOLTAIC / ROBOTIC AUTOMATION / PNEUMATICS / AUTOMOTIVE



Aluminum heat sinks for Led lighting

Round milled comb heat sinks for LEDs
-only round milling with various diameters -raw



HALF LIFE DRAWINGS (1:2) - SCALE 1:2

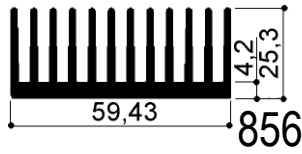

BAR MILLING

DIAMETRO: da 27mm a 60/66mm

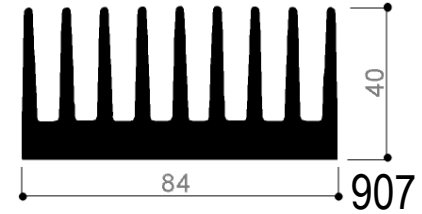
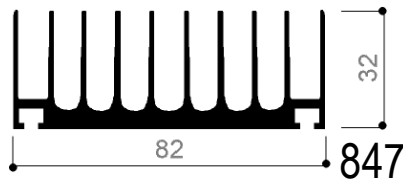
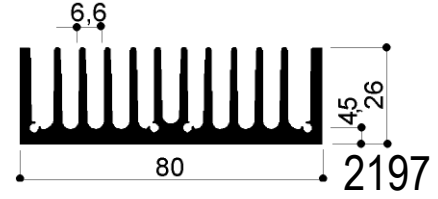
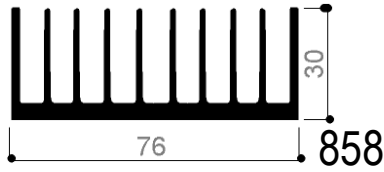
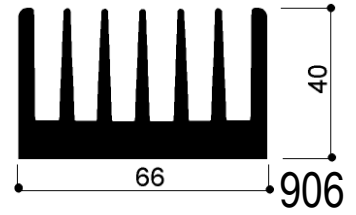
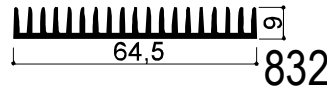

BAR MILLING

DIAMETRO: da 40mm a 76/80/82/84mm

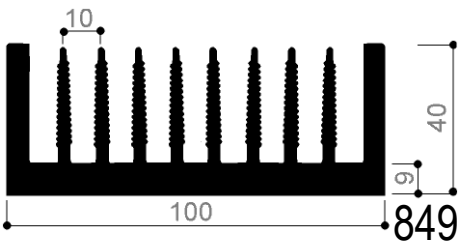
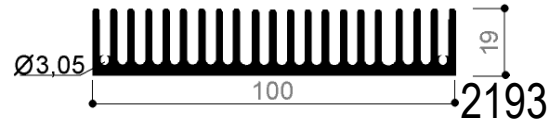
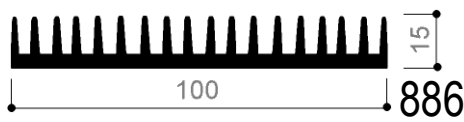

BAR MILLING

DIAMETRO: da 40mm a 100mm

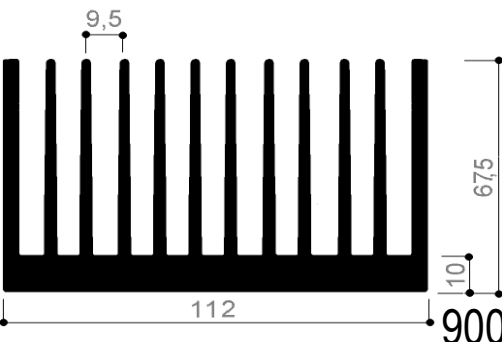

BAR MILLING

DIAMETRO: da 40mm a 112/114mm

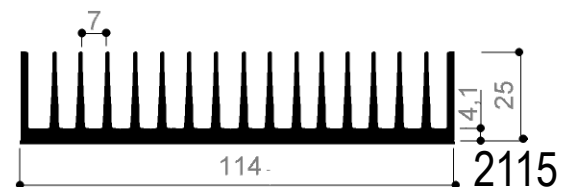
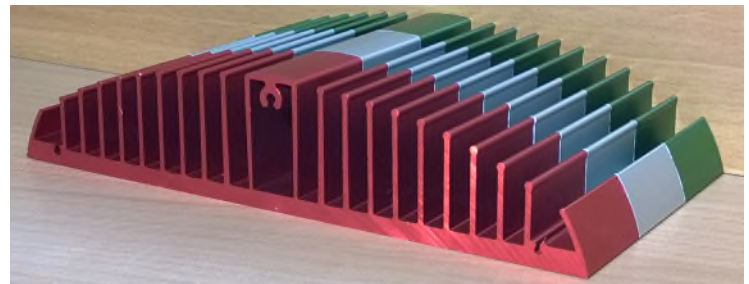

Via Newton, n.12
20016 Pero (Milano - Italy)
Tel.+39 02 3535955 r.a. Fax.+39 02 3539929
E-Mail: info@omar-alluminio.it

Cataloghi Online: www.omar-alluminio.it

www.omar-alluminio.com

CUSTOM ALUMINUM PROFILES / STANDARD / SPECIAL / AND FOR:

ELECTRONICS / LED / PHOTOVOLTAIC / ROBOTIC AUTOMATION / PNEUMATICS / AUTOMOTIVE

OMAR s.r.l.
PROFILATI ALLUMINIO
ALTA TECNOLOGIA

Aluminum heat sinks for Led lighting



Round milled comb heat sinks for LEDs
-only round milling with various diameters -raw

HALF LIFE DRAWINGS (1:2) - SCALE 1:2

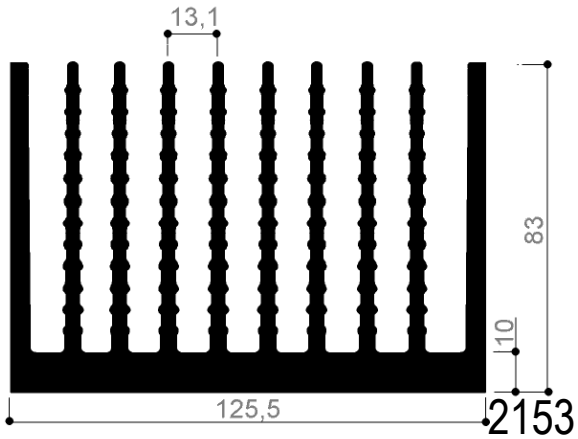
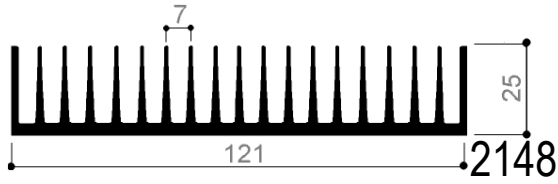
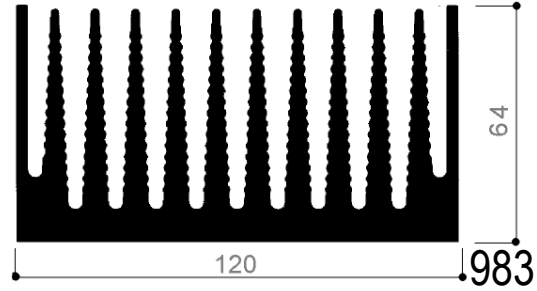
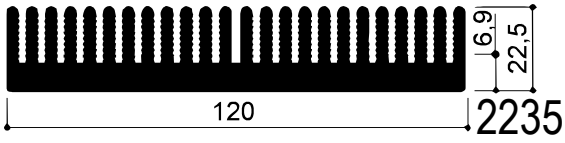

BAR MILLING

DIAMETRO: da 40mm a 120/121/125mm

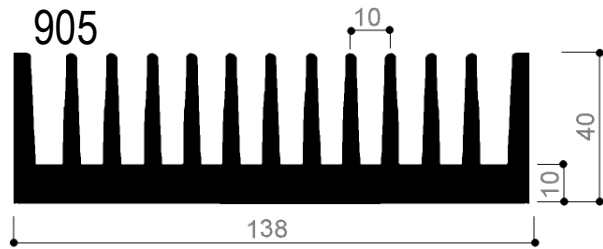
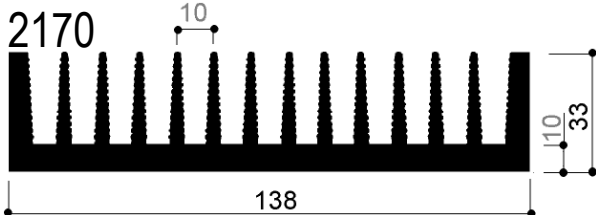
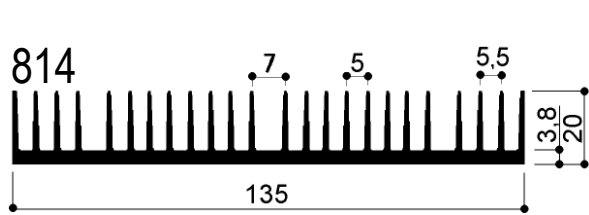

BAR MILLING

DIAMETRO: da 40mm a 120/125/135/138mm

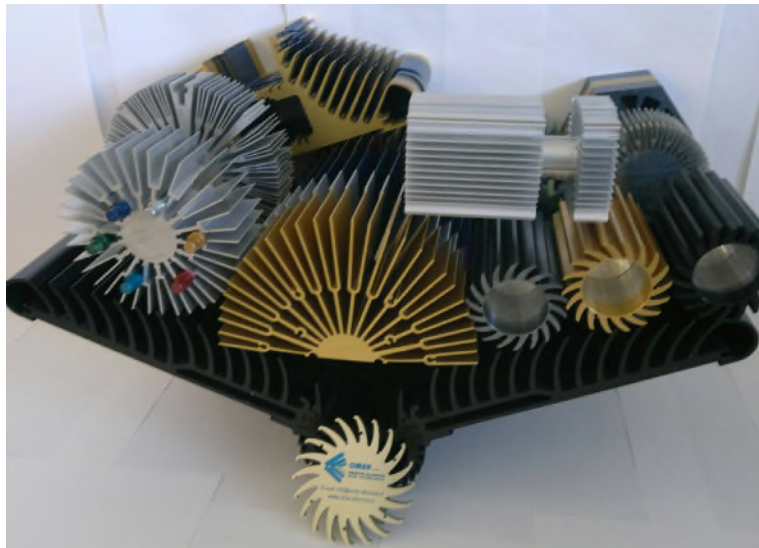

Cataloghi Online: www.omar-alluminio.it

www.omar-alluminio.com

CUSTOM ALUMINUM PROFILES / STANDARD / SPECIAL / AND FOR:

ELECTRONICS / LED / PHOTOVOLTAIC / ROBOTIC AUTOMATION / PNEUMATICS / AUTOMOTIVE

Via Newton, n.12

20016 Pero (Milano - Italy)

Tel. +39 02 3535955 r.a. Fax. +39 02 35339929

E.Mail: info@omar-alluminio.it

- REPRODUCTION PROHIBITED -
CONTINUOUS UPDATE - ED. 12-2024



Aluminum heat sinks for Led lighting

Round milled comb heat sinks for LEDs
-only round milling with various diameters -raw



HALF LIFE DRAWINGS (1:2) - SCALE 1:2

BAR MILLING

DIAMETRO: da 40mm a 150/158/160mm

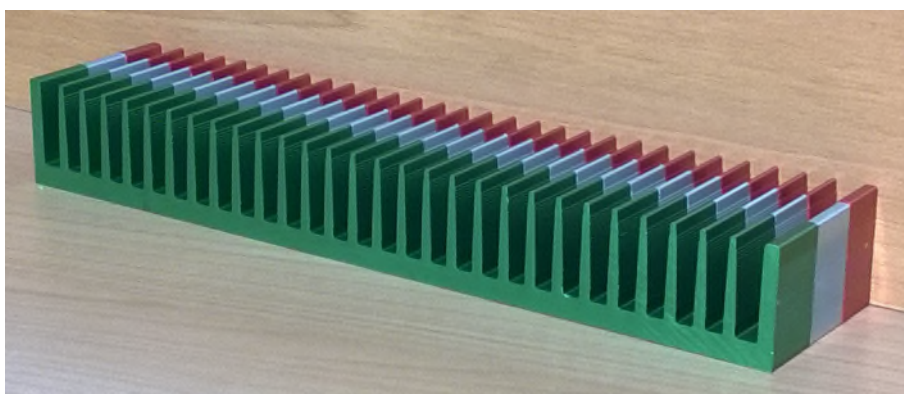
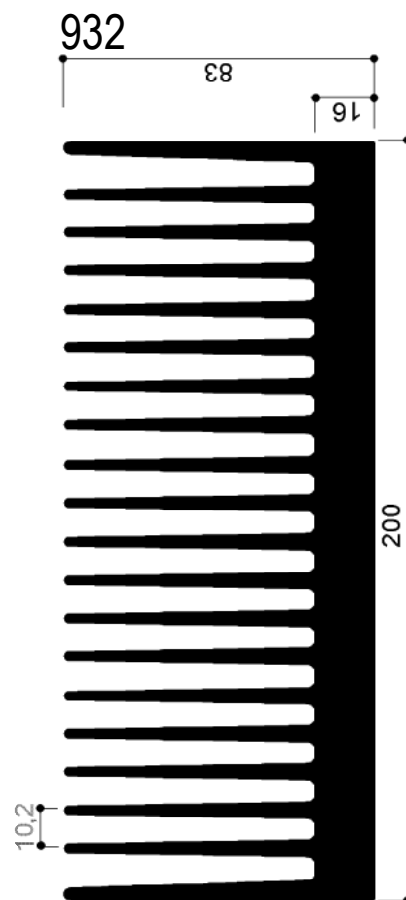
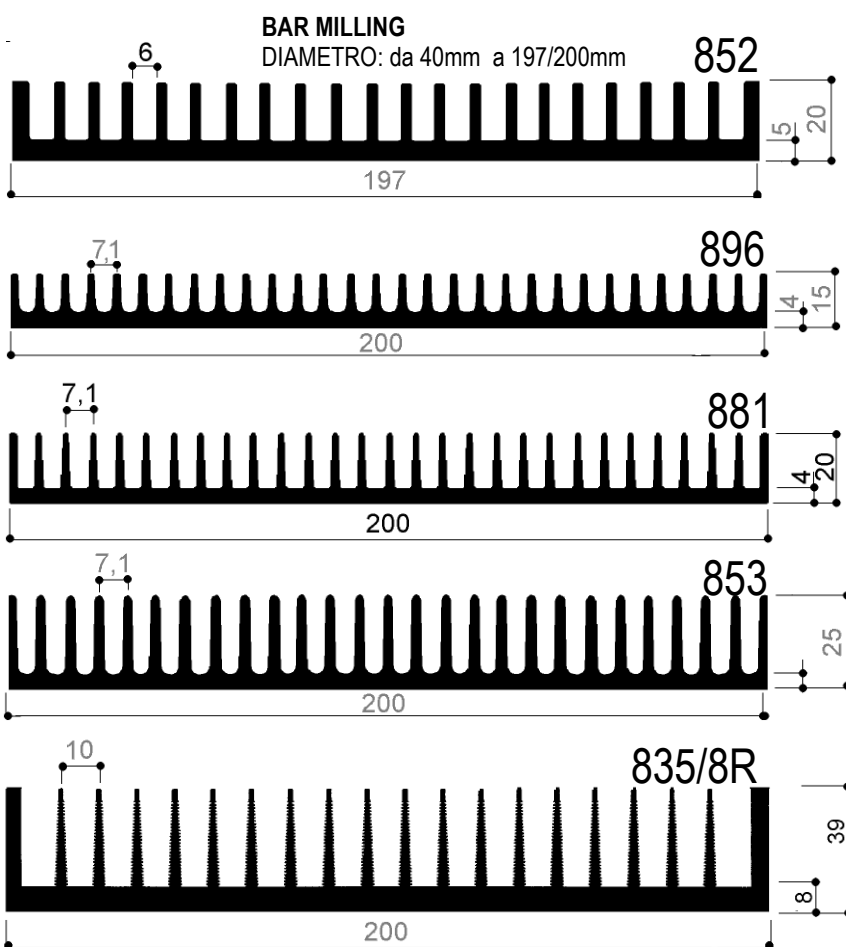
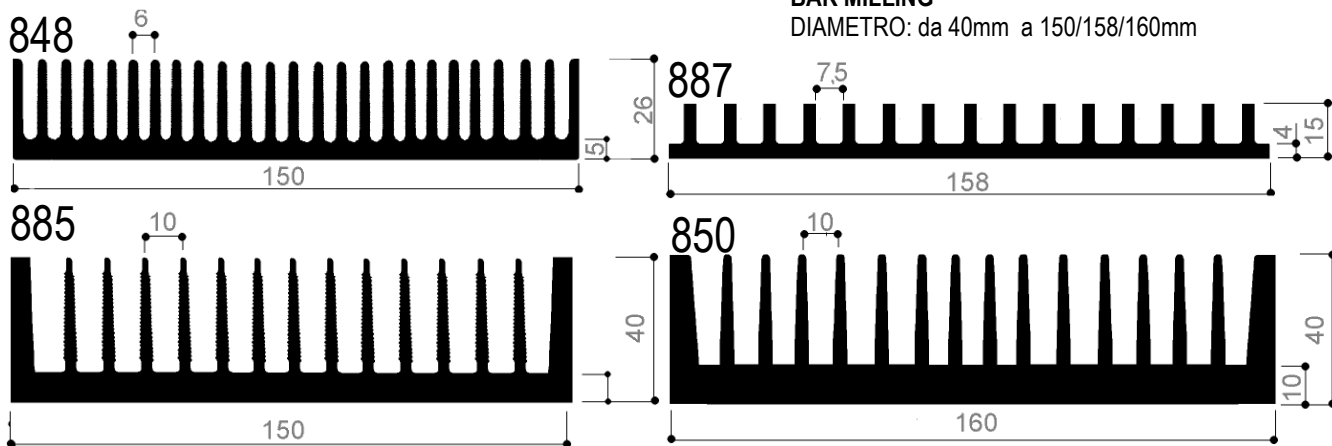

Via Newton, n.12
20016 Pero (Milano - Italy)
Tel.+39 02 3535955 r.a. Fax.+39 02 3539929
E-Mail: info@omar-alluminio.it

Cataloghi Online: www.omar-alluminio.it
www.omar-alluminio.com
CUSTOM ALUMINUM PROFILES / STANDARD / SPECIAL / AND FOR:
ELECTRONICS / LED / PHOTOVOLTAIC / ROBOTIC AUTOMATION / PNEUMATICS / AUTOMOTIVE

-REPRODUCTION PROHIBITED
CONTINUOUS UPDATE - ED. 12-2024

Aluminum heat sinks for Led lighting

Round milled comb heat sinks for LEDs
-only round milling with various diameters -raw



HALF LIFE DRAWINGS (1:2) - SCALE 1:2

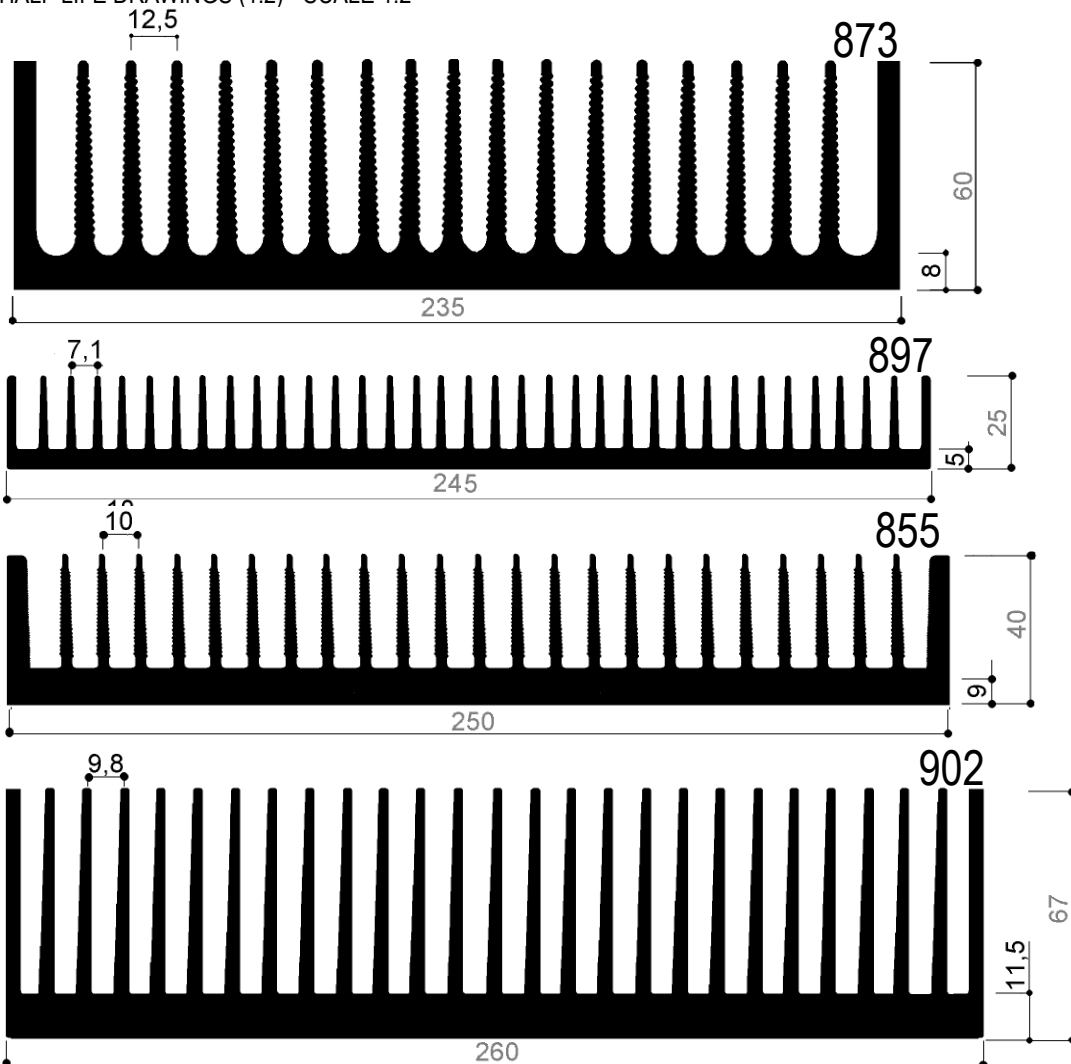

BAR MILLING

DIAMETRO: da 40mm a 235/245/260mm

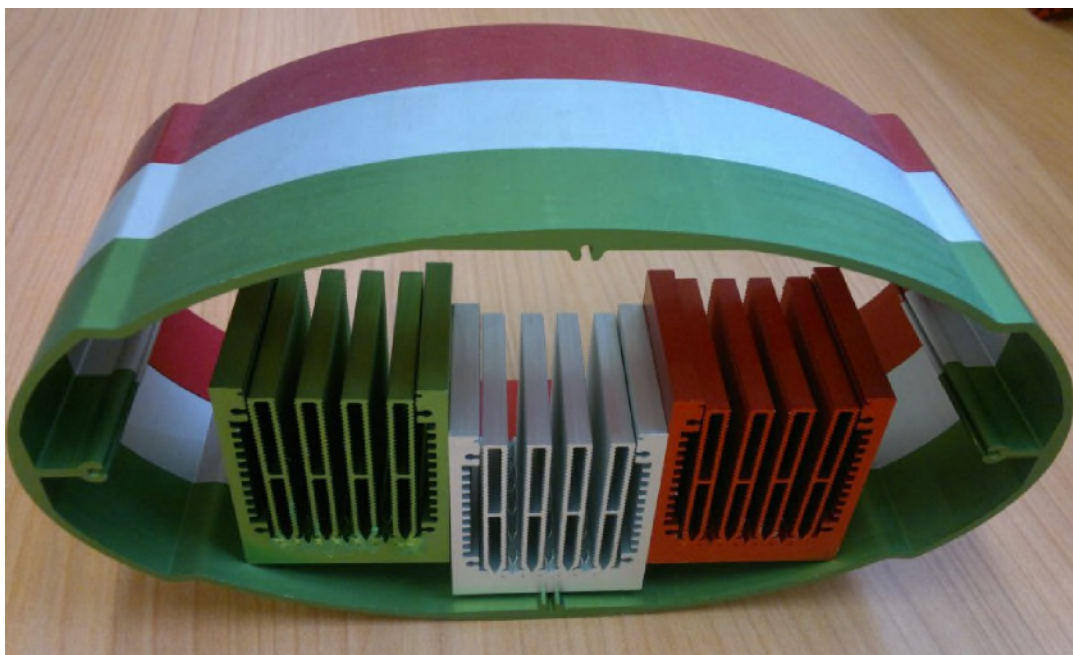

Cataloghi Online: www.omar-alluminio.it

www.omar-alluminio.com

CUSTOM ALUMINUM PROFILES / STANDARD / SPECIAL / AND FOR:

ELECTRONICS / LED / PHOTOVOLTAIC / ROBOTIC AUTOMATION / PNEUMATICS / AUTOMOTIVE

Via Newton, n.12

20016 Pero (Milano - Italy)

Tel. +39 02 3535955 r.a. Fax. +39 02 3539929

E.Mail: info@omar-alluminio.it

-REPRODUCTION PROHIBITED - CONTINUOUS UPDATE - ED. 12-2024



Aluminum heat sinks for Led lighting

Round milled comb heat sinks for LEDs
-only round milling with various diameters -raw



Via Newton, n.12
20016 Pero (Milano - Italy)
Tel. +39 02 3535955 r.a. Fax. +39 02 3539929
E.Mail: info@omar-alluminio.it

Cataloghi Online: www.omar-alluminio.it
www.omar-alluminio.com
CUSTOM ALUMINUM PROFILES / STANDARD / SPECIAL / AND FOR:
ELECTRONICS / LED / PHOTOVOLTAIC / ROBOTIC AUTOMATION / PNEUMATICS / AUTOMOTIVE

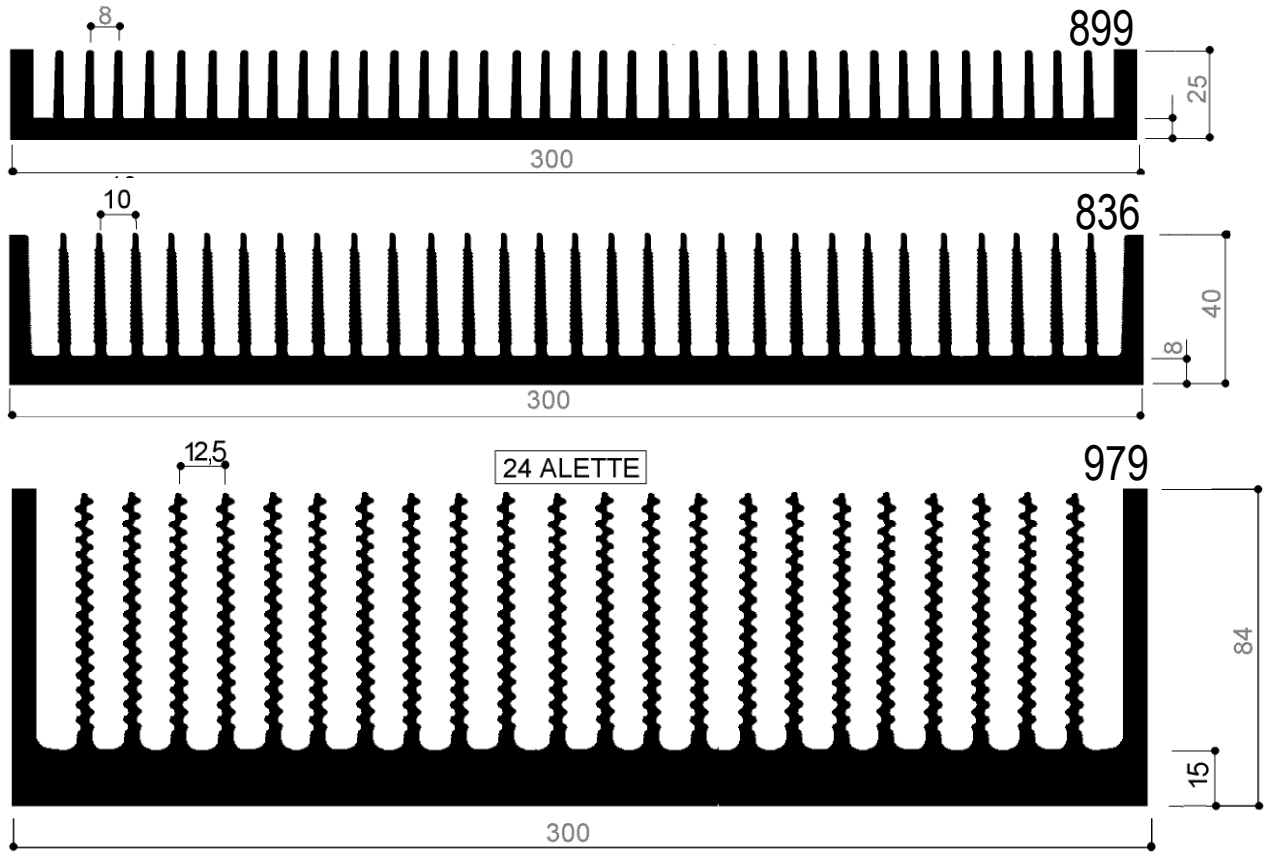

BAR MILLING
DIAMETRO: da 40mm a 300mm

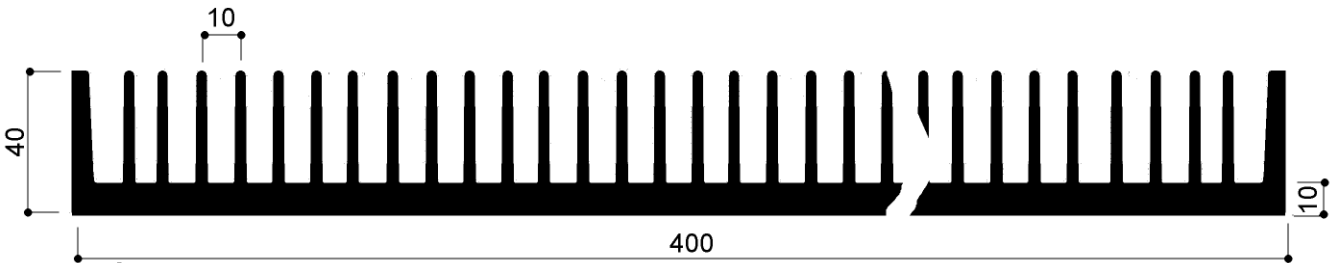

BAR MILLING
DIAMETRO: da 40mm a 400mm

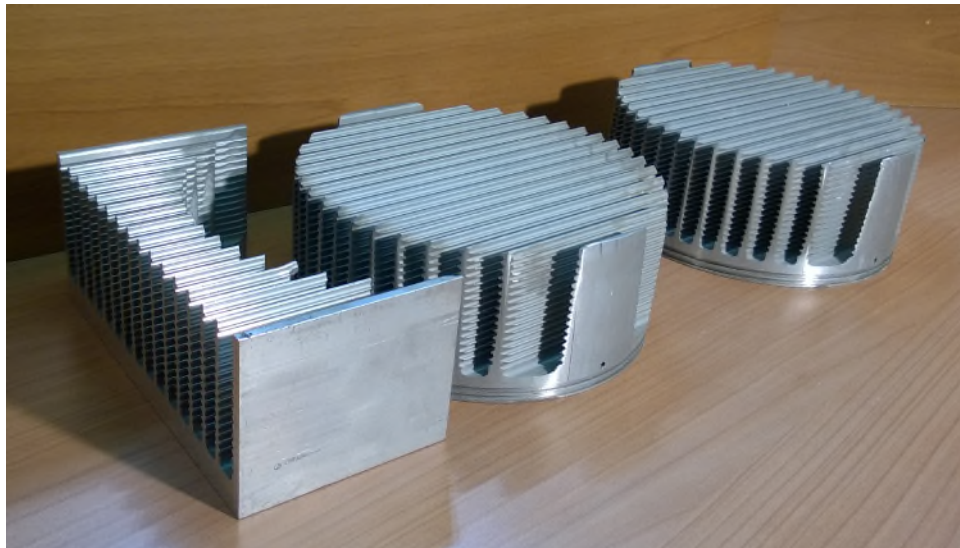

FIERA MILANO RHO - PERO

MONZA

AUTOSTRADA
MILANO-TORINO
TANGENZIALE
OVEST

AUTOSTRADA
MILANO-VENEZIA

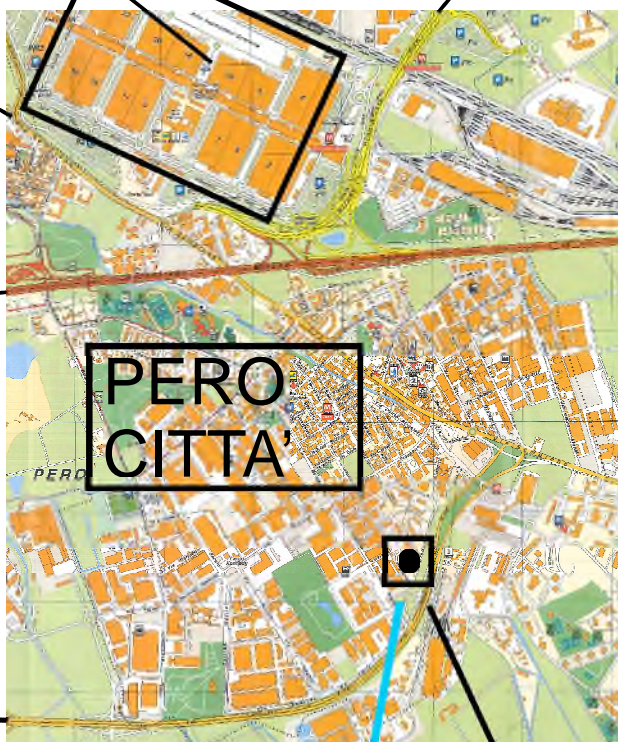

MILANO CITTA'
VIA GALLARATE

TANGENZIALE OVEST

DIREZIONE GENOVA DIREZIONE TORINO

USCITA PERO SUD ZONA
INDUSTRIALE



OMAR s.r.l.
PROFILATI ALLUMINIO
ALTA TECNOLOGIA

Via Newton, n.12
20016 Pero (Milano - Italy)
Tel.+39 02 3535955 r.a.
Fax.+39 02 3539929
E.Mail: info@omar-alluminio.it

Consult our updated catalogue online at:

www.omar-alluminio.it

www.omar-alluminio.com

www.omar-alluminio.eu

ALUMINUM PROFILES
ACCORDING TO DRAWING-STANDARD-SPECIAL



AND FOR: ELECTRONICS-LED-PHOTOVOLTAICS
ROBOT-PNEUMATIC-AUTOMOTIVE AUTOMATION