

- °profilé aluminium standards
custom shapes aluminium profiles.
- °dissipateur aluminium profilé
- °Dissipateur thermique extrudé
Dissipateur thermique en Aluminium
(extrusion)high-dissipation
aluminium profiles heat sinks
- °profil pour LED
- °CNC Machining Parts
- °Boîtiers électroniques
- °profilés aluminium très modulaires

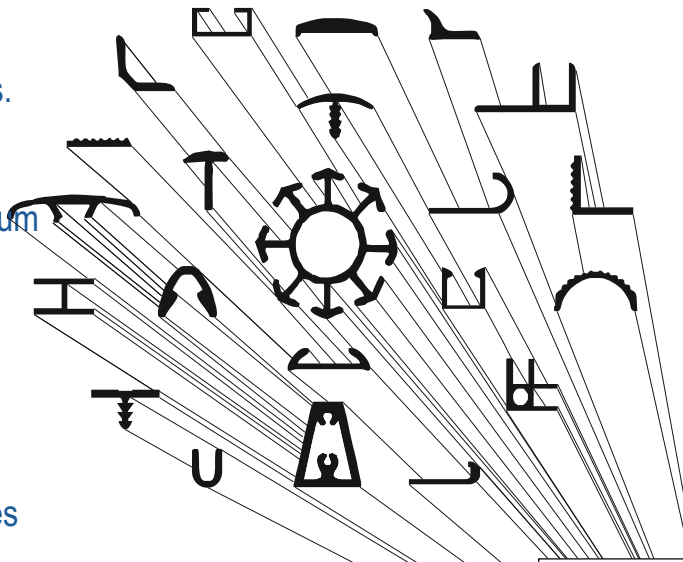

OMAR s.r.l.
PROFILATI ALLUMINIO
ALTA TECNOLOGIA

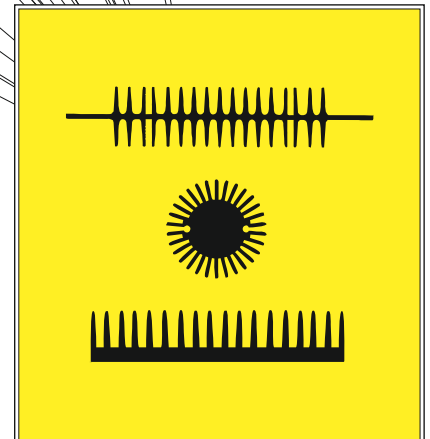

Le "molte forme" della billetta d'alluminio
Dissipateur thermique en Aluminium
Edizione Febbraio 2017

Consultate il catalogo aggiornato online su:
www.omar-alluminio.it
www.omar-alluminio.com
www.dissipatori.com

- °Profilati per pneumatica
- °Profilati per stand
- °Profilati per battiscopa
copri fili zoccolini
- °Prodotti derivati da profili
di alluminio
- °Lavorazione meccanica
profili di alluminio

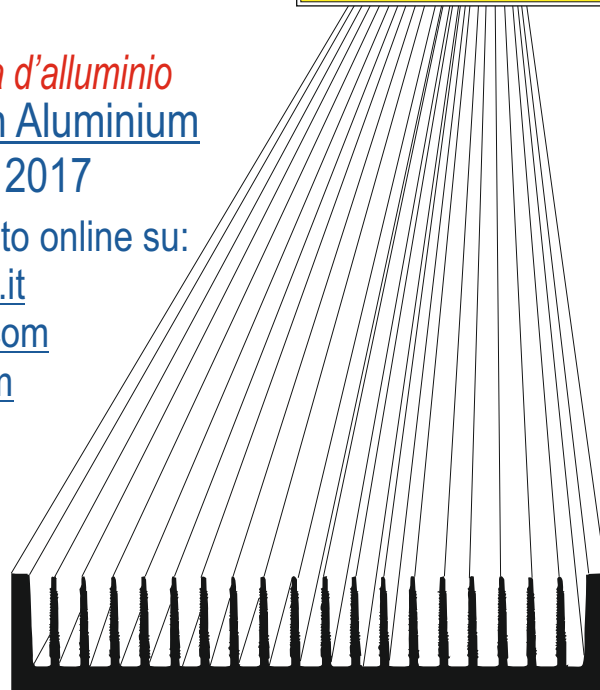

Via Newton, n.12
20016 Pero (Milano - Italy)
Tel.+39 02 3535955 r.a.
Fax.+39 02 3539929
E.Mail: info@omar-alluminio.it

PROFILATI IN ALLUMINIO
A DISEGNO-STANDARD-SPECIALI



ED: ELETTRONICA-LED-FOTOVOLTAICO
AUTOMAZIONE-ROBOTICA-PNEUMATICA-AUTOMOTIVE

Dissipatori di calore in alluminio per illuminazione a Led

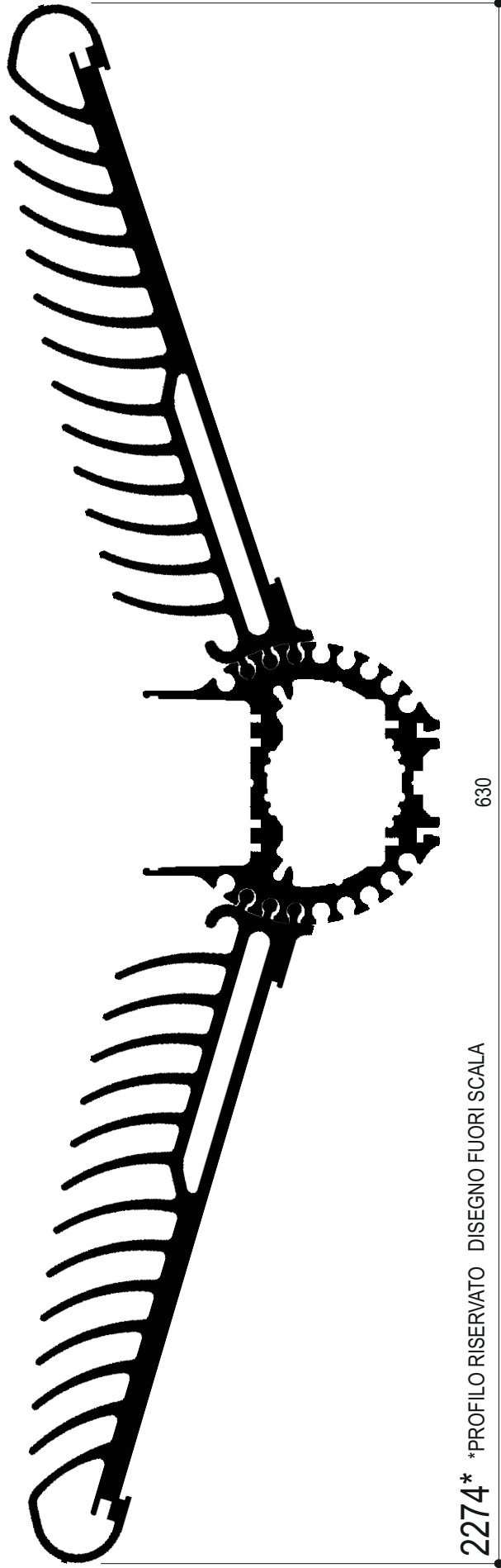

2274* *PROFILO RISERVATO DISEGNO FUORI SCALA

630

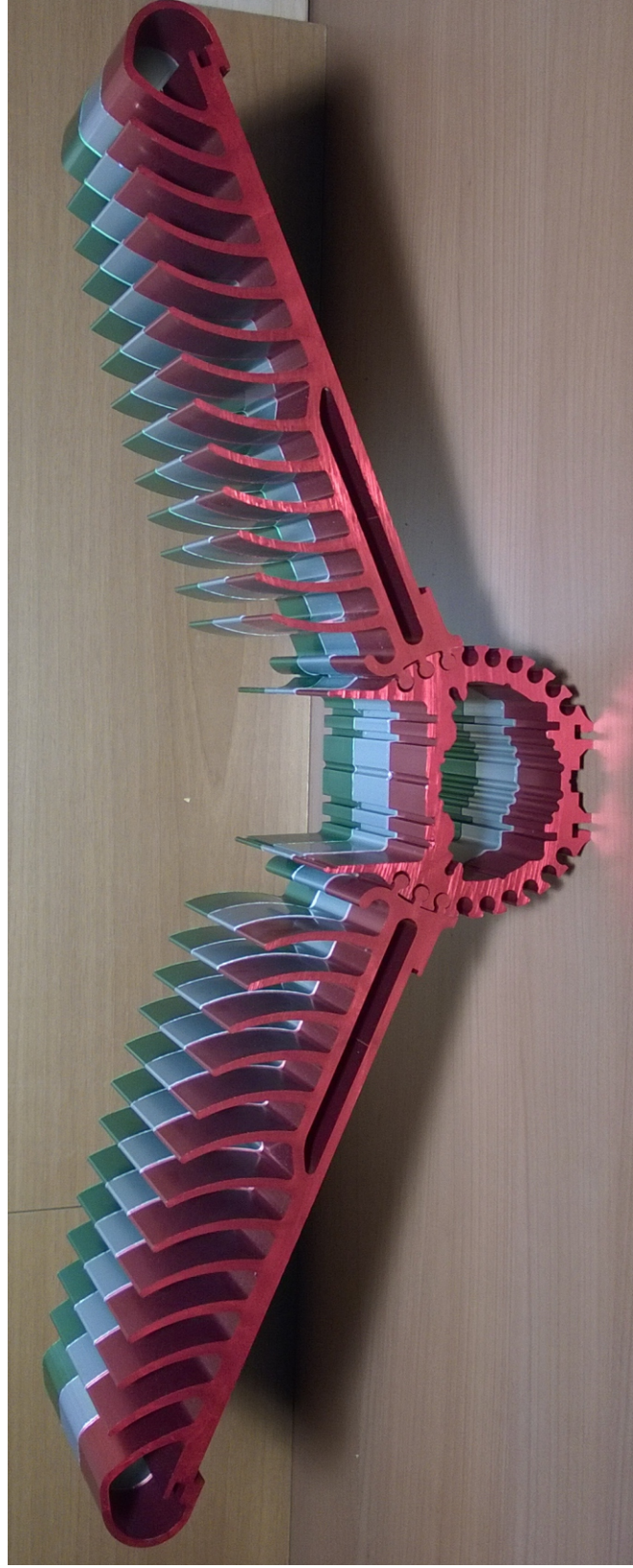

Dissipatori di calore in alluminio per illuminazione a Led

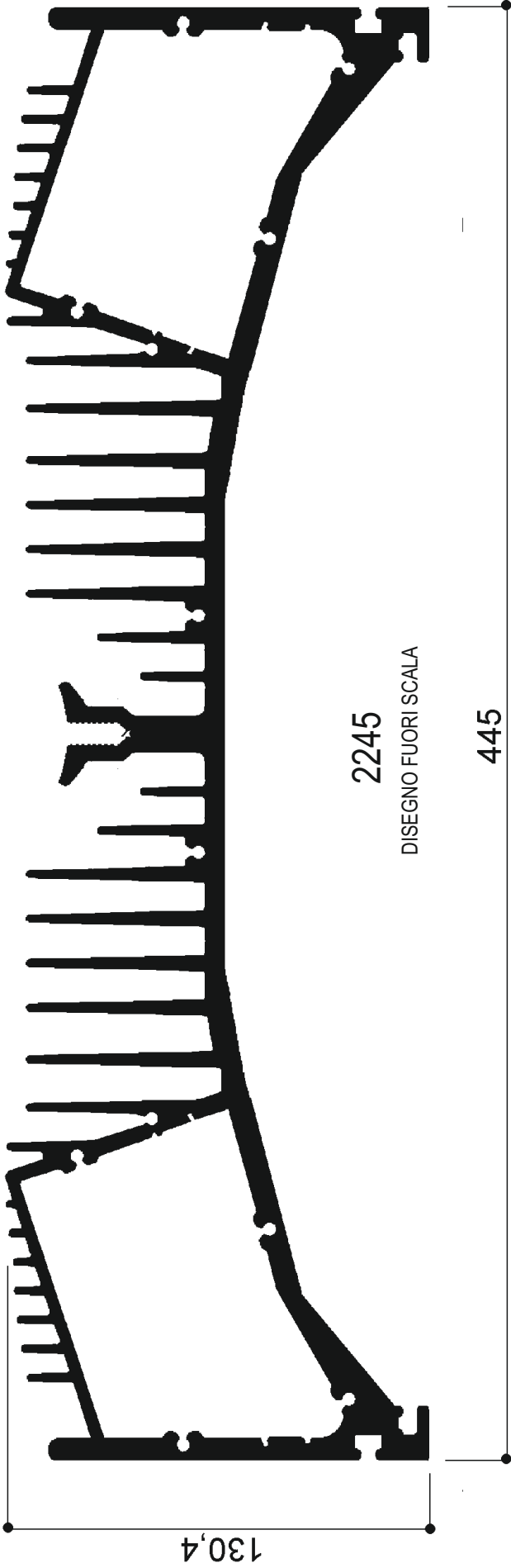

2245

DISEGNO FUORI SCALA

445

130,4

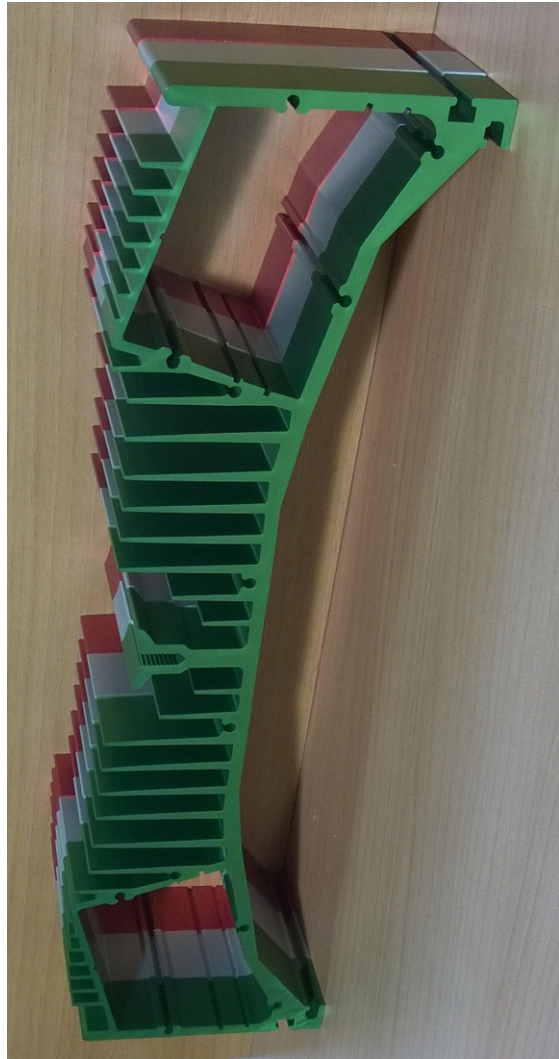

Cataloghi Online: www.omar-alluminio.it

www.omar-alluminio.com

PROFILATI ALLUMINIO A DISEGNO / STANDARD / SPECIALI / E PER:

ELETTRONICA / LED / FOTOVOLTAICO / AUTOMAZIONE ROBOTICA / PNEUMATICA / AUTOMOTIVE

Via Newton, n.12

20016 Pero (Milano - Italy)

Tel. +39 02 3535955 r.a. Fax. +39 02 3539929

E-Mail: info@omar-alluminio.it



Dissipatori di calore in alluminio per illuminazione a Led

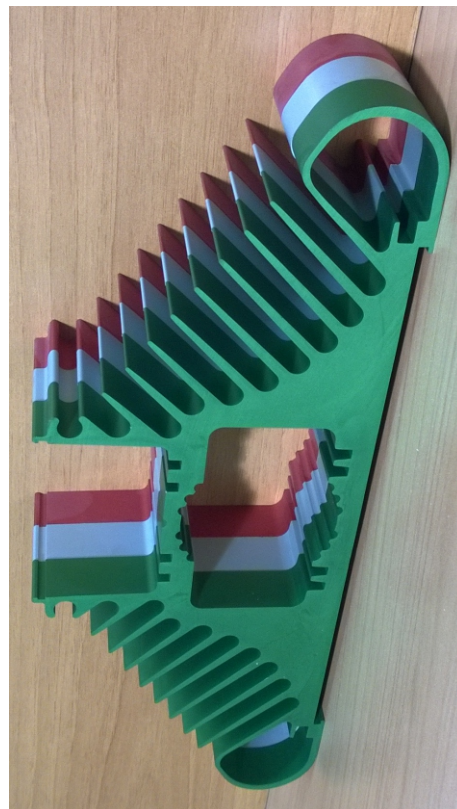
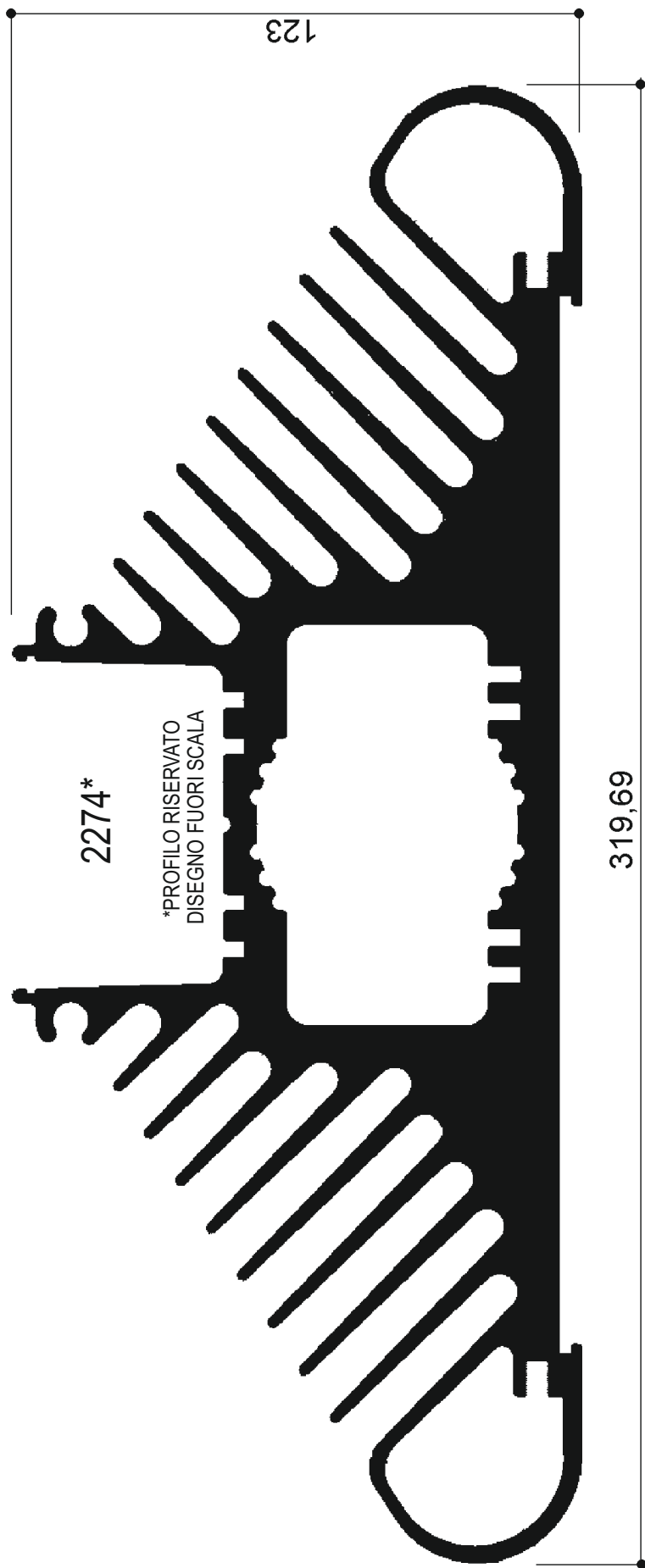

Dissipatori di calore in alluminio per illuminazione a Led



***PROFILO RISERVATO**
DISEGNO FUORI SCALA

2271*

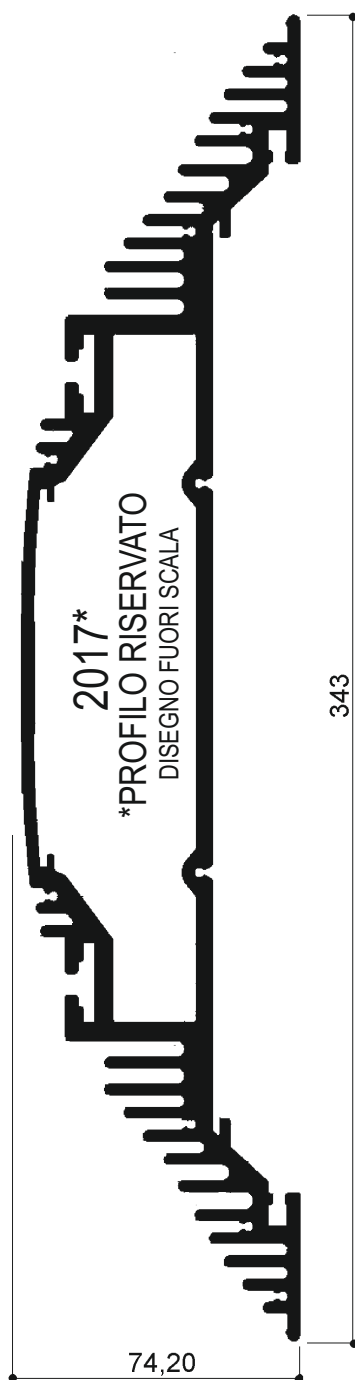
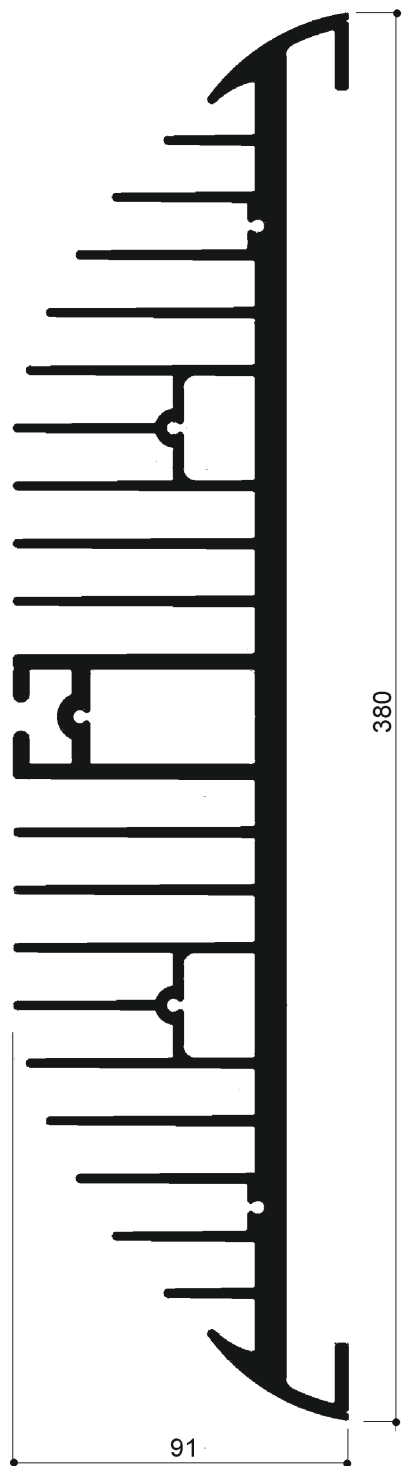

2017*
***PROFILO RISERVATO**
DISEGNO FUORI SCALA

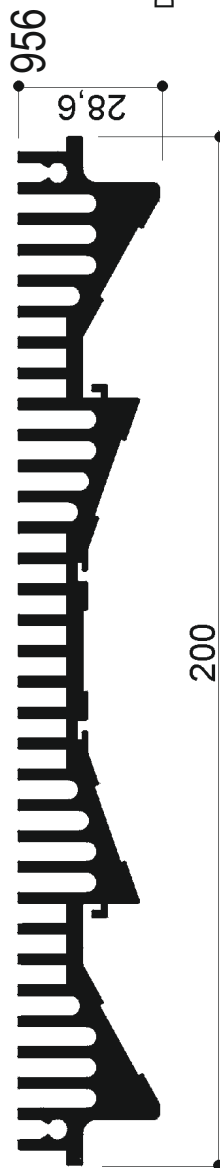

DISEGNO FUORI SCALA

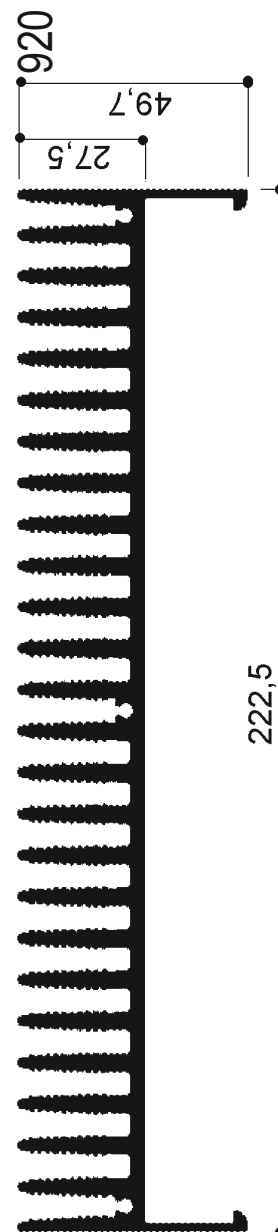

-RIPRODUZIONE VIETATA-
AGGIORNAMENTO CONTINUO - ED. DEL 05/-



Cataloghi Online: www.omar-alluminio.it

www.omar-alluminio.com

PROFILATI ALLUMINIO A DISEGNO / STANDARD / SPECIALI / E PER:

ELETTRONICA / LED / FOTOVOLTAICO / AUTOMAZIONE ROBOTICA / PNEUMATICA / AUTOMOTIVE

Via Newton, n.12

20016 Pero (Milano - Italy)

Tel. +39 02 3535955 r.a. Fax. +39 02 3539929

E-Mail: info@omar-alluminio.it

Dissipatori di calore in alluminio per illuminazione a Led

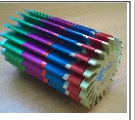

DISEGNI AL VERO (1:1)- SCALE 1:1

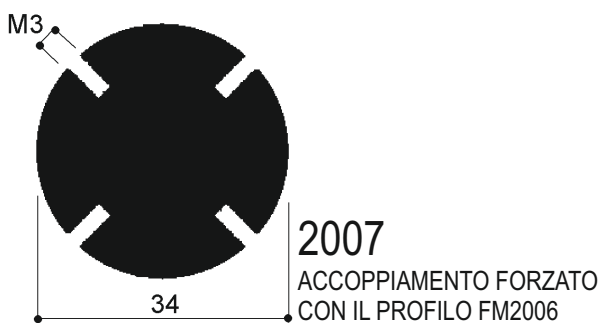
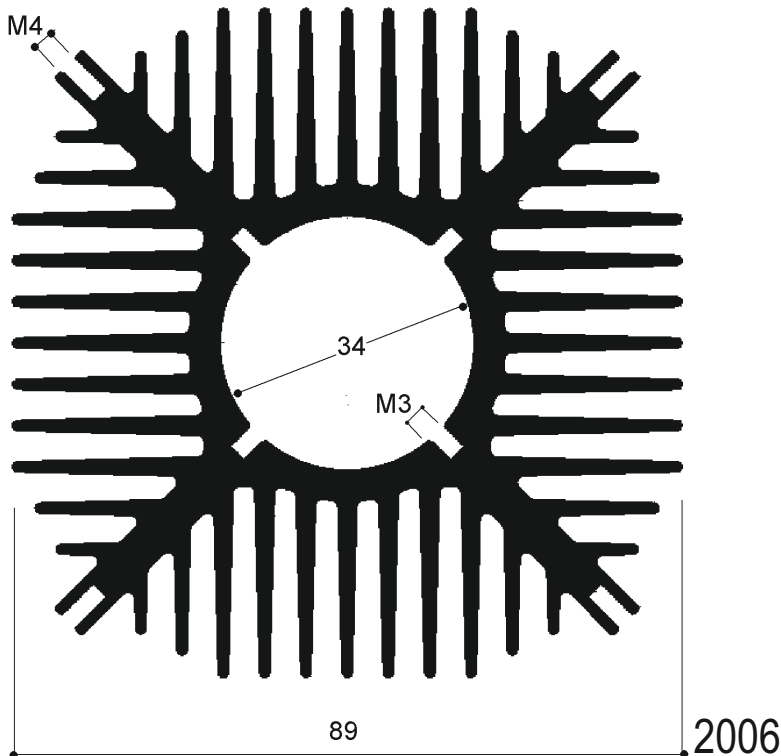
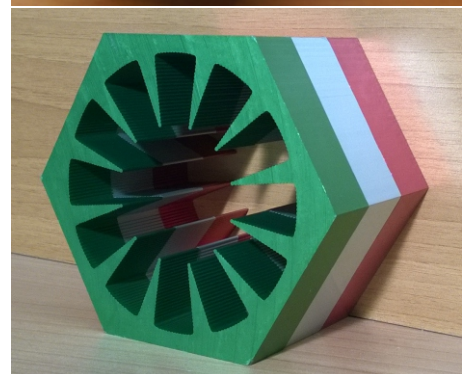
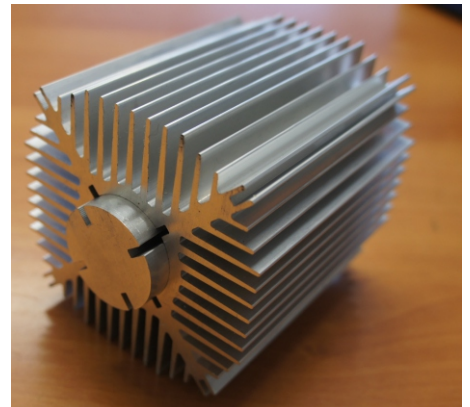
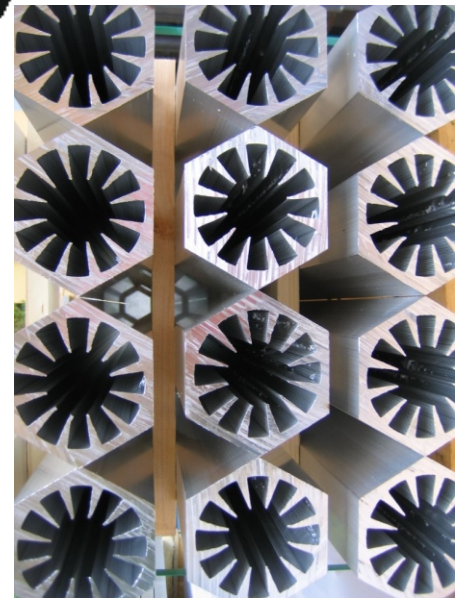
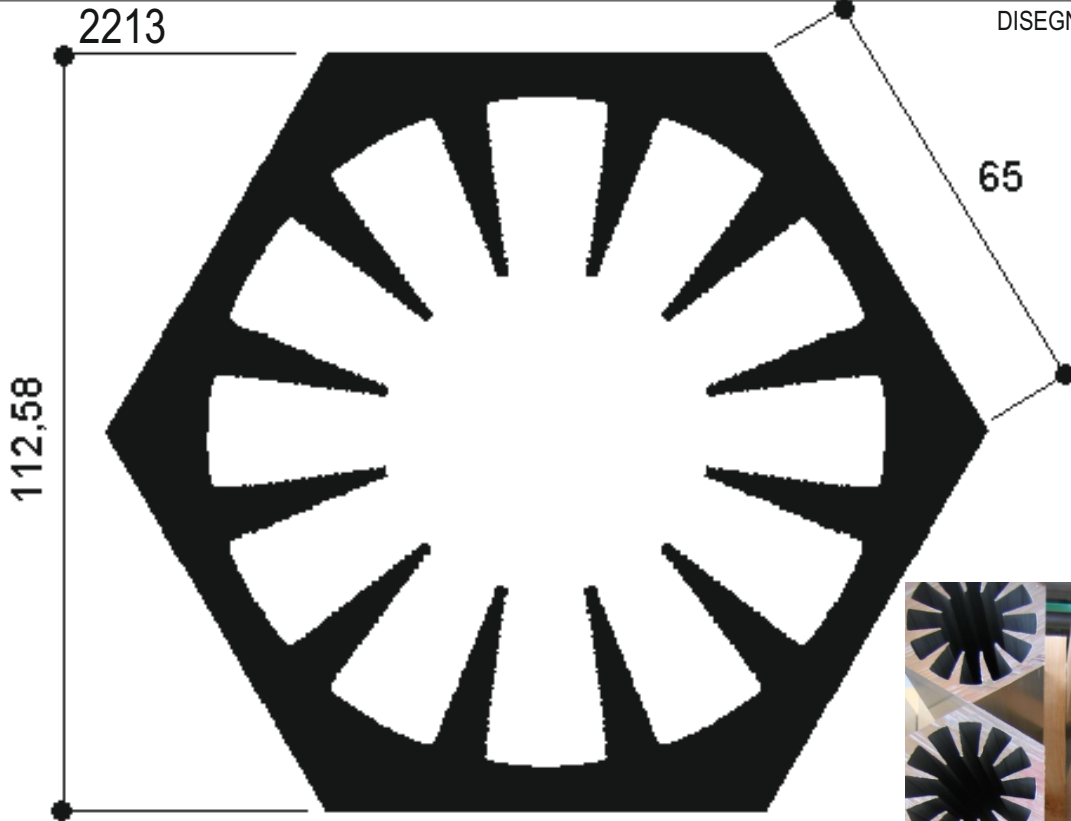

Via Newton, n.12

20016 Pero (Milano - Italy)

Tel. +39 02 3535955 r.a. Fax. +39 02 3539929

E-Mail: info@omar-alluminio.it

Cataloghi Online: www.omar-alluminio.it

www.omar-alluminio.com

PROFILATI ALLUMINIO A DISEGNO / STANDARD / SPECIALI / E PER:

ELETRONICA / LED / FOTOVOLTAICO / AUTOMAZIONE ROBOTICA / PNEUMATICA / AUTOMOTIVE



Dissipatori di calore in alluminio per illuminazione a Led



DISEGNO FUORI SCALA

*PROFILO RISERVATO

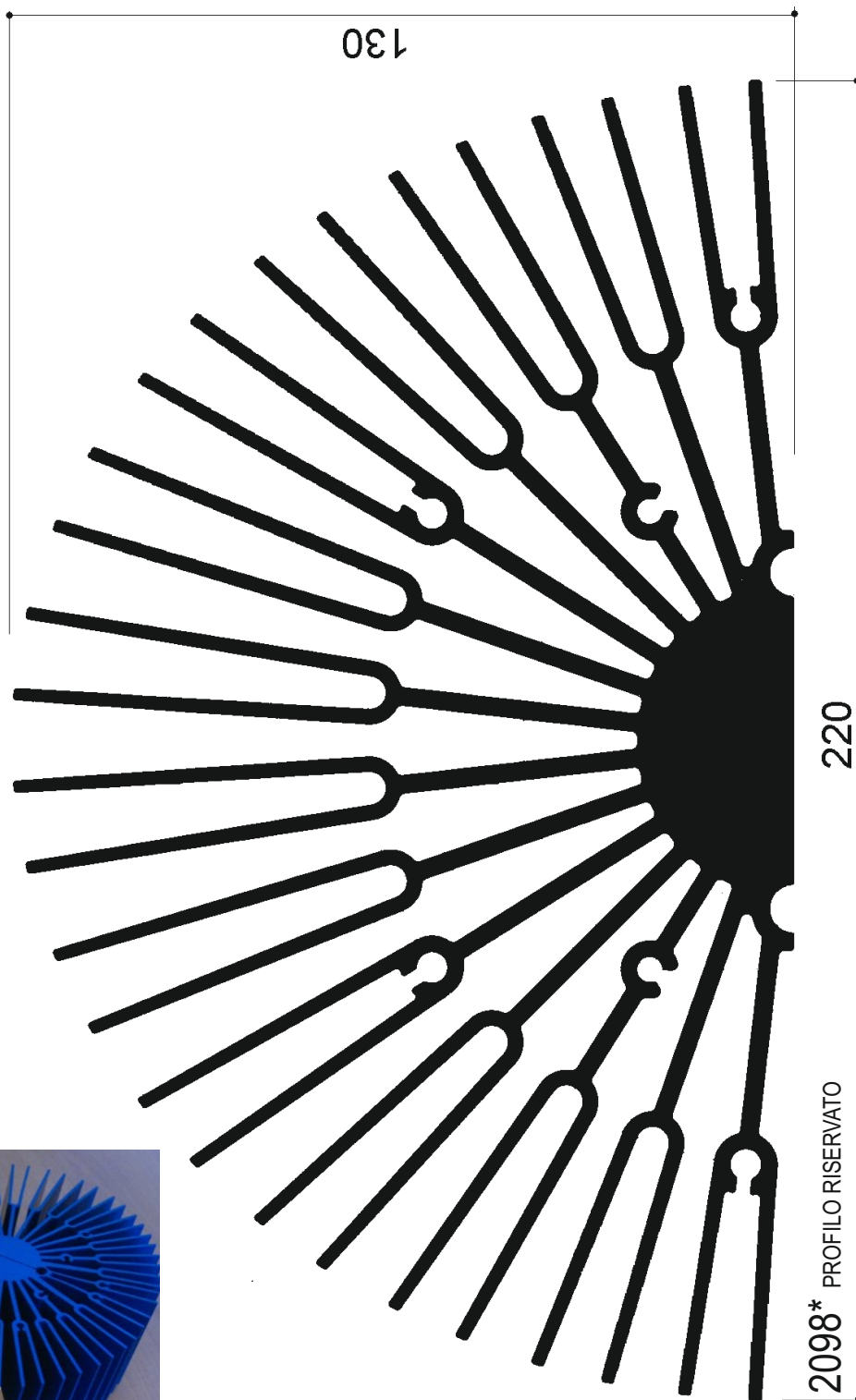

Cataloghi Online: www.omar-alluminio.it

www.omar-alluminio.com

PROFILATI ALLUMINIO A DISEGNO / STANDARD / SPECIALI / E PER:

ELETTRONICA / LED / FOTVOLTAICO / AUTOMAZIONE ROBOTICA / PNEUMATICA / AUTOMOTIVE

Via Newton, n.12

20016 Pero (Milano - Italy)

Tel. +39 02 3535955 r.a. Fax. +39 02 3539929

E-Mail: info@omar-alluminio.it



Dissipatori di calore tondi in alluminio per illuminazione a Led



Via Newton, n.12

20016 Pero (Milano - Italy)

Tel. +39 02 3535955 r.a. Fax. +39 02 3539929

E-Mail: info@omar-alluminio.it

Cataloghi Online: www.omar-alluminio.it

www.omar-alluminio.com

PROFILATI ALLUMINIO A DISEGNO / STANDARD / SPECIALI / E PER:

ELETTRONICA / LED / FOTOVOLTAICO / AUTOMAZIONE ROBOTICA / PNEUMATICA / AUTOMOTIVE

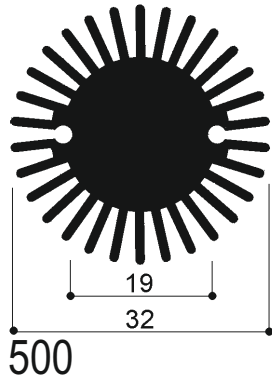
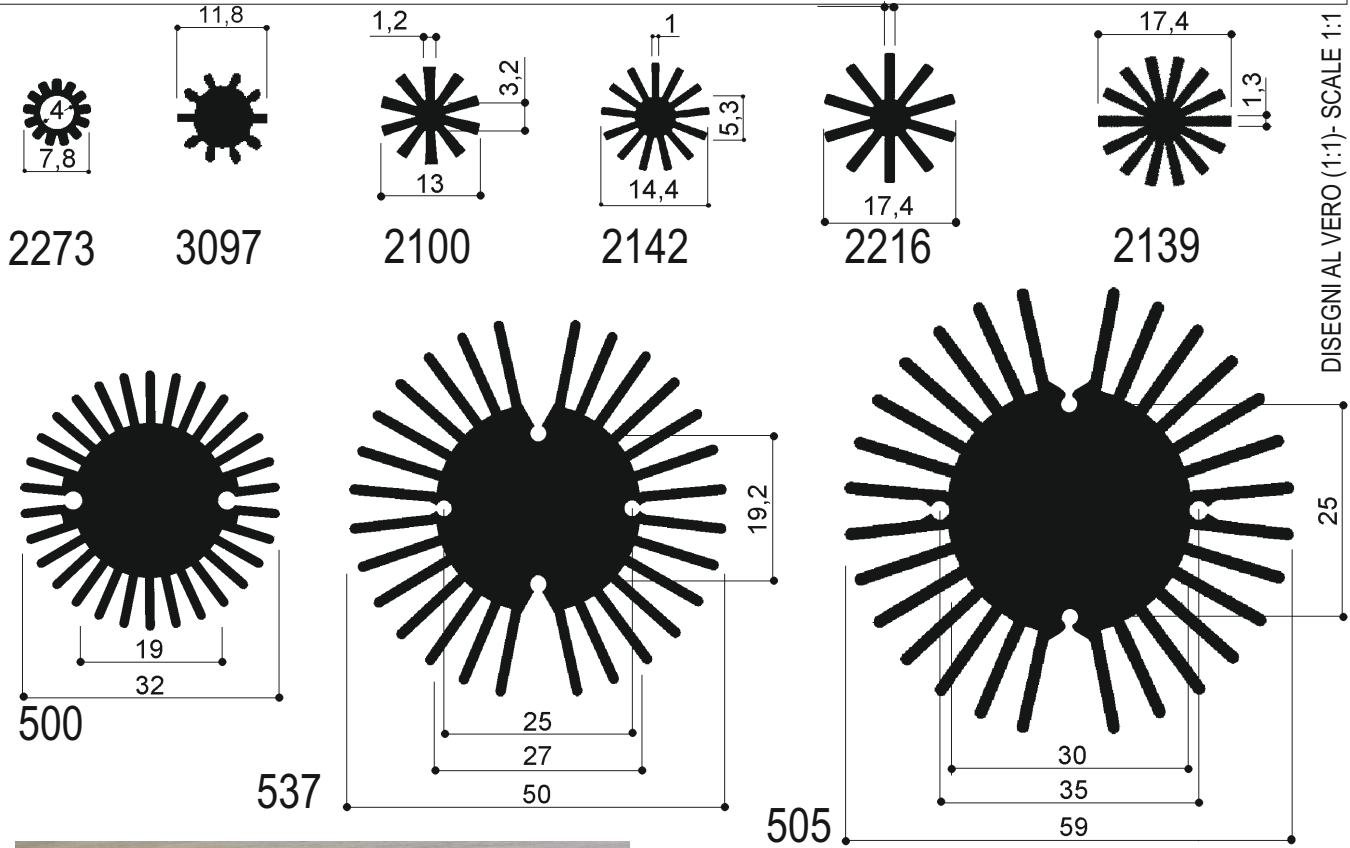

537

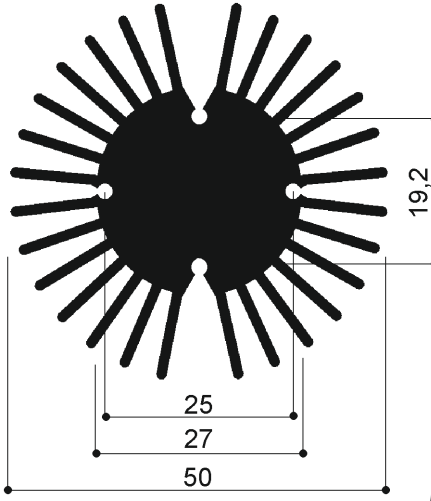

505

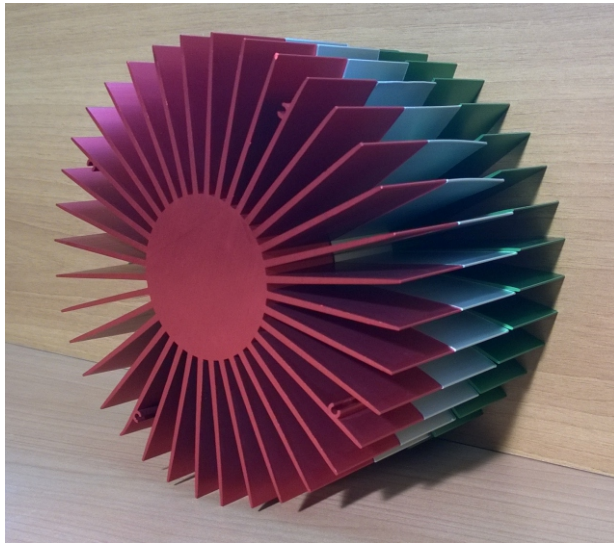
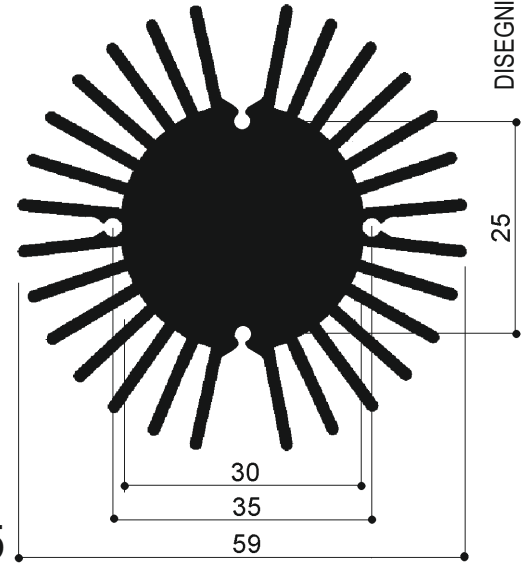

AGGIORNAMENTO CONTINUO - ED. DEL 5-2015
-RIPRODUZIONE VIETATA-

2074D46

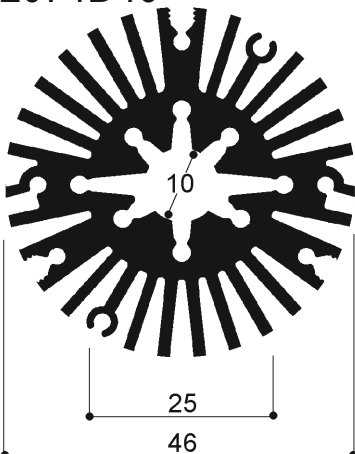

2074

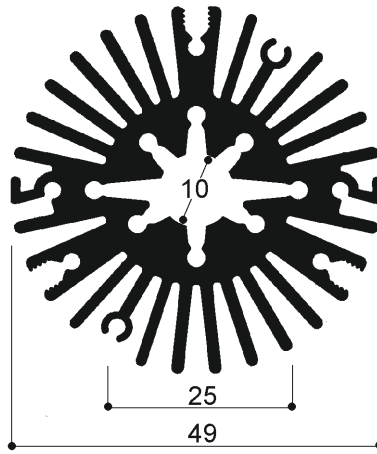

509

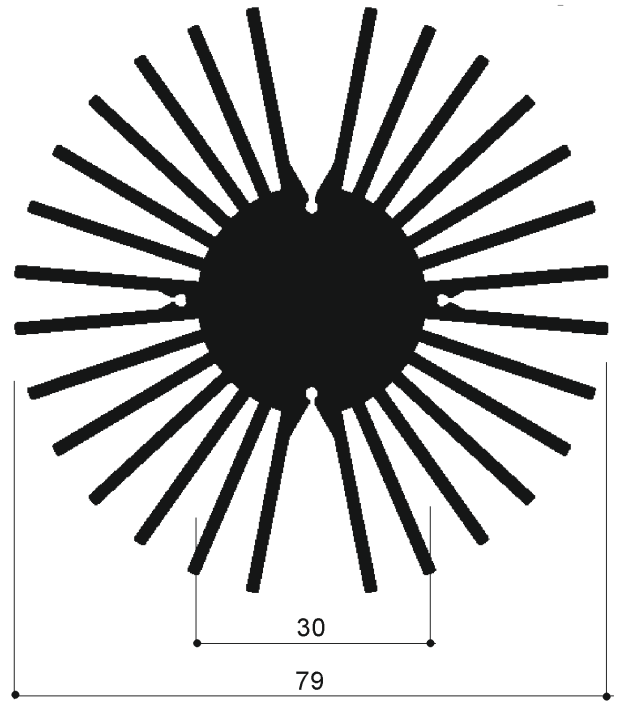

2074C

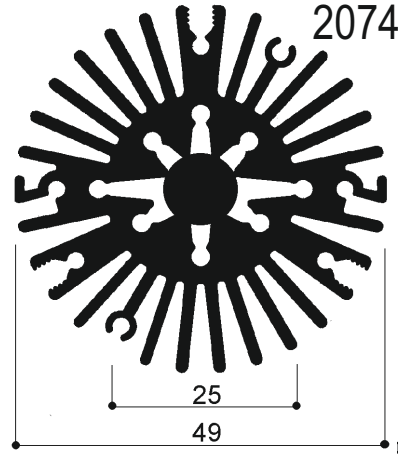

Dissipatori di calore tondi in alluminio per illuminazione a Led



DISEGNI AL VERO (1:1)- SCALE 1:1

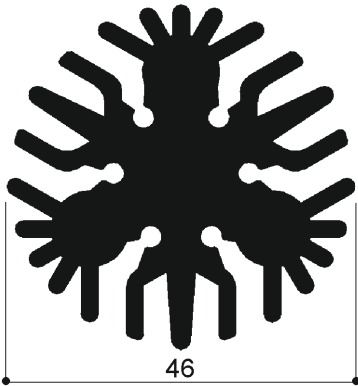
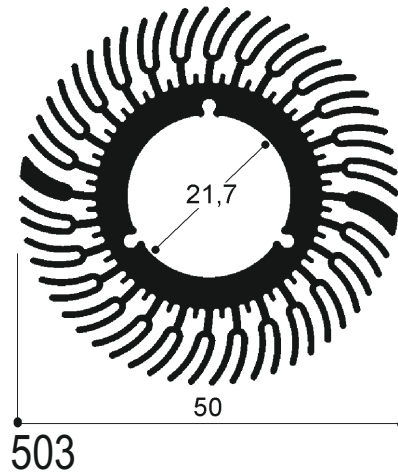
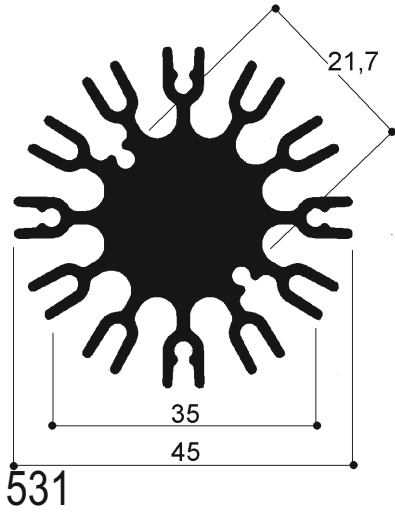

2072D46

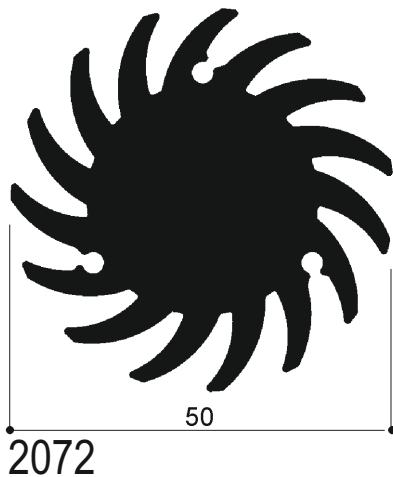

2072

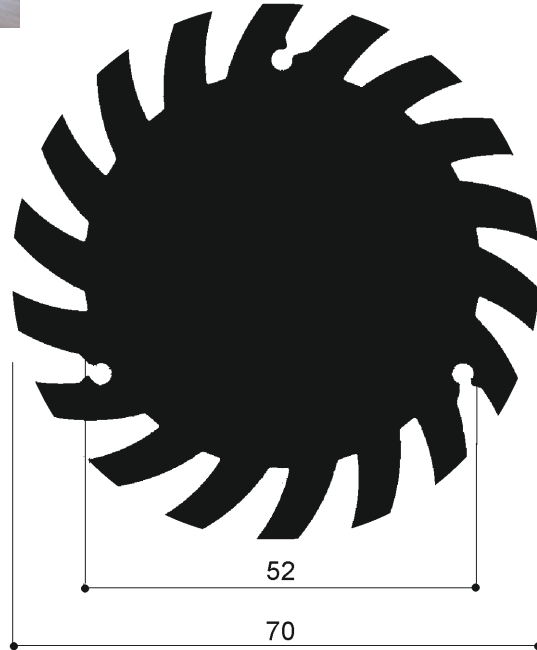

2073D70

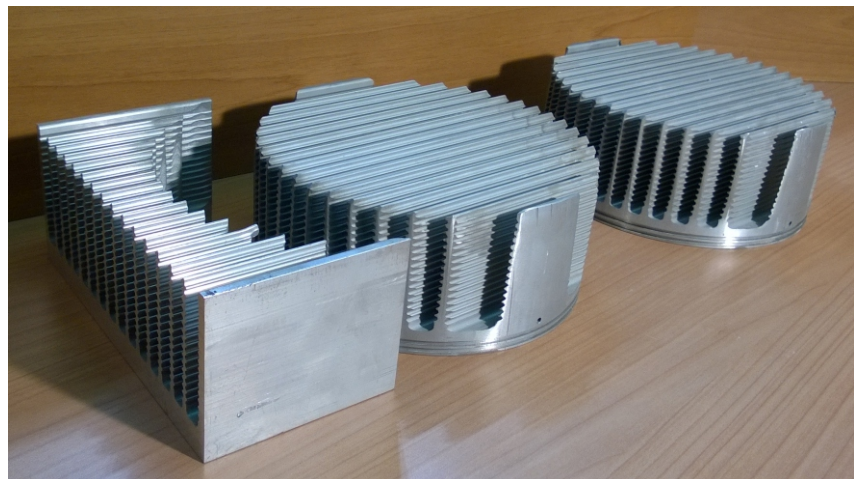

Cataloghi Online: www.omar-alluminio.it

www.omar-alluminio.com

PROFILATI ALLUMINIO A DISEGNO / STANDARD / SPECIALI / E PER:

ELETTRONICA / LED / FOTOVOLTAICO / AUTOMAZIONE ROBOTICA / PNEUMATICA / AUTOMOTIVE

Via Newton, n.12

20016 Pero (Milano - Italy)

Tel. +39 02 3535955 r.a. Fax. +39 02 3539929

E-Mail: info@omar-alluminio.it



Dissipatori di calore tondi in alluminio per illuminazione a Led



DISEGNI AL VERO (1:1)- SCALE 1:1

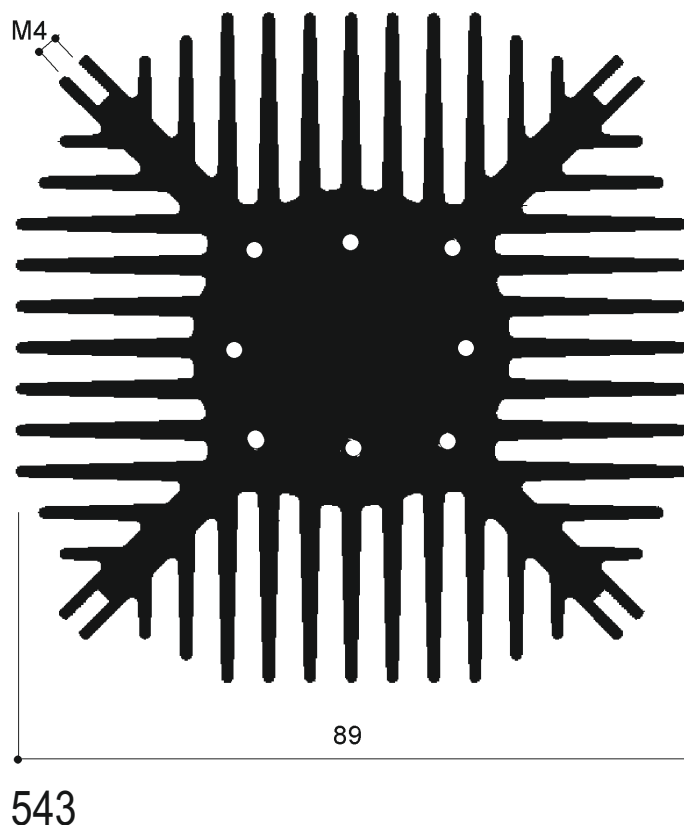
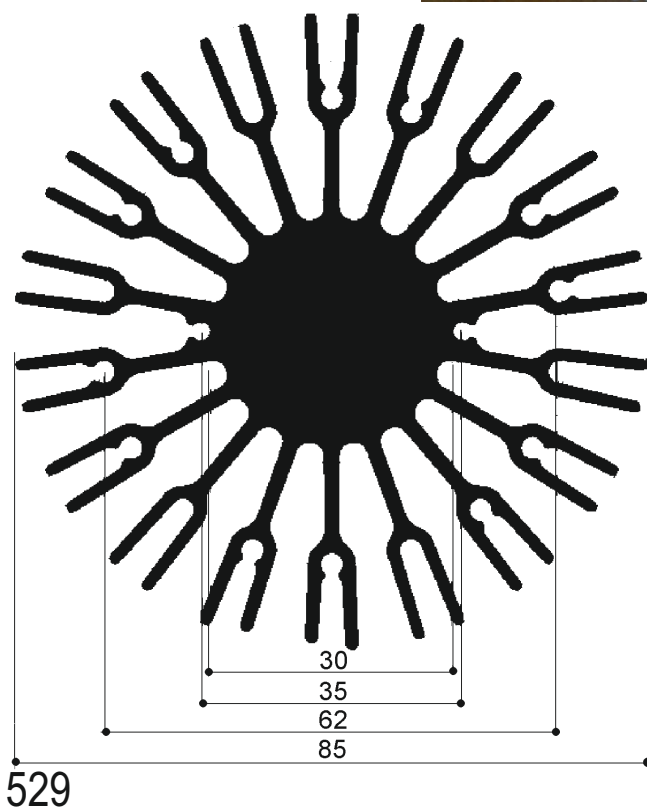
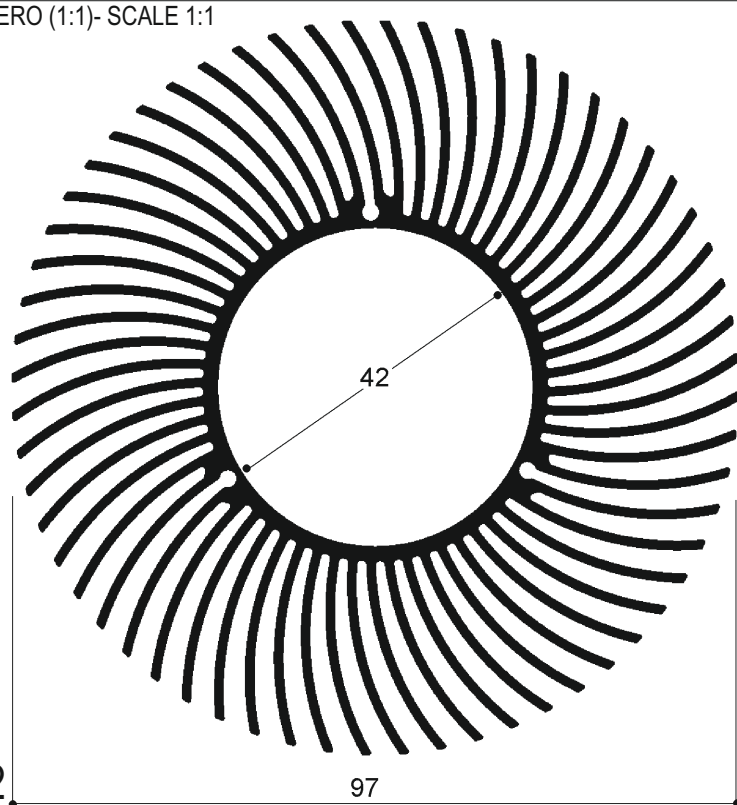
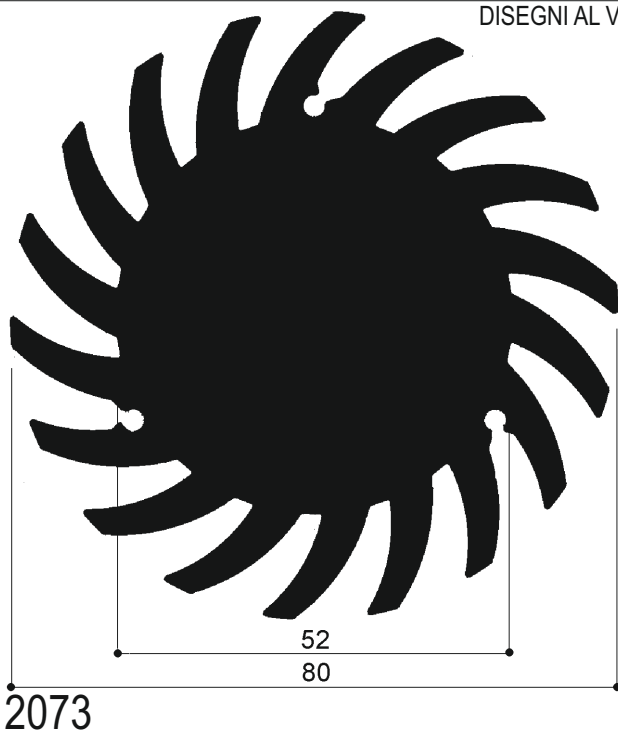

Via Newton, n.12

20016 Pero (Milano - Italy)

Tel. +39 02 3535955 r.a. Fax. +39 02 3539929

E-Mail: info@omar-alluminio.it

Cataloghi Online: www.omar-alluminio.it

www.omar-alluminio.com

PROFILATI ALLUMINIO A DISEGNO / STANDARD / SPECIALI / E PER:

ELETTRONICA / LED / FOTOVOLTAICO / AUTOMAZIONE ROBOTICA / PNEUMATICA / AUTOMOTIVE

OMAR s.r.l.
PROFILATI ALLUMINIO
ALTA TECNOLOGIA



Dissipatori di calore tondi in alluminio per illuminazione a Led



DISEGNI AL VERO (1:1)- SCALE 1:1

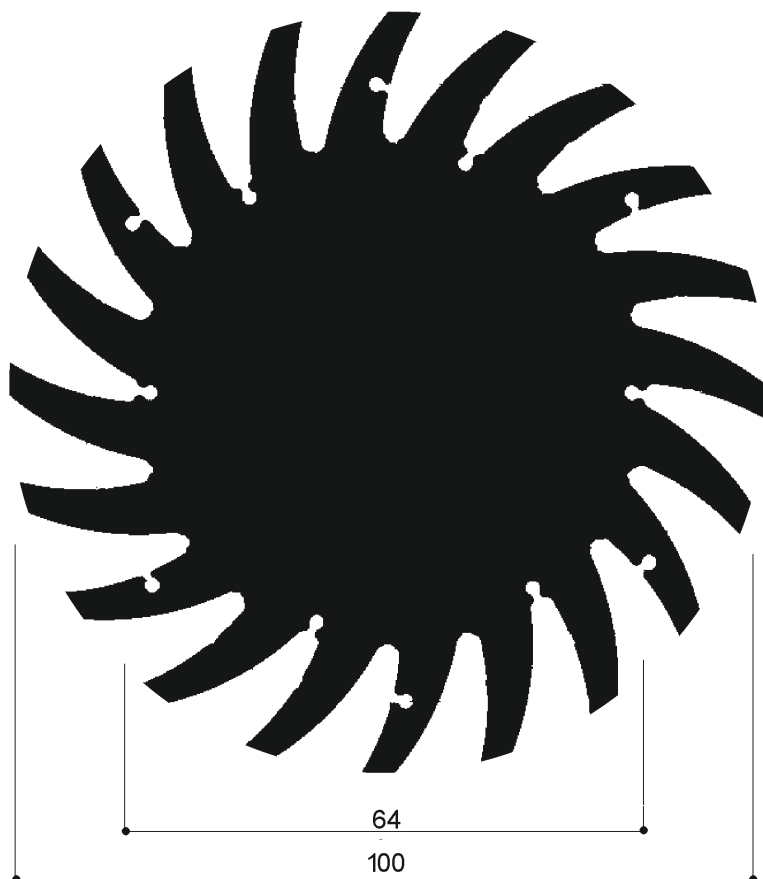

2076D100

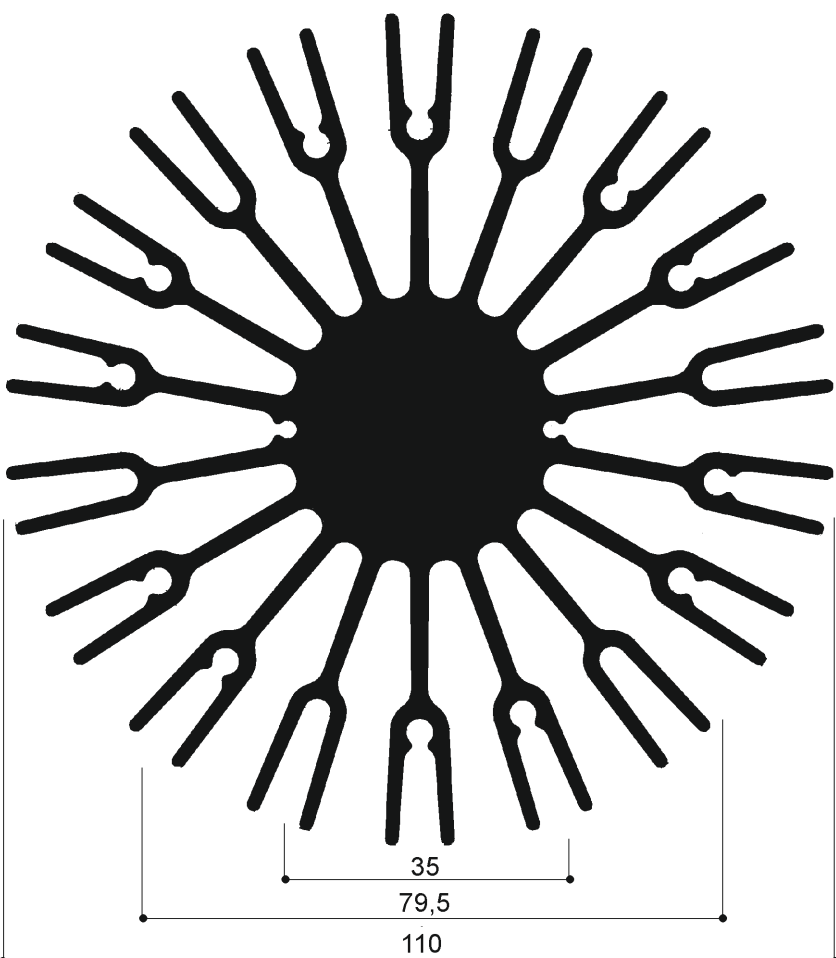

532

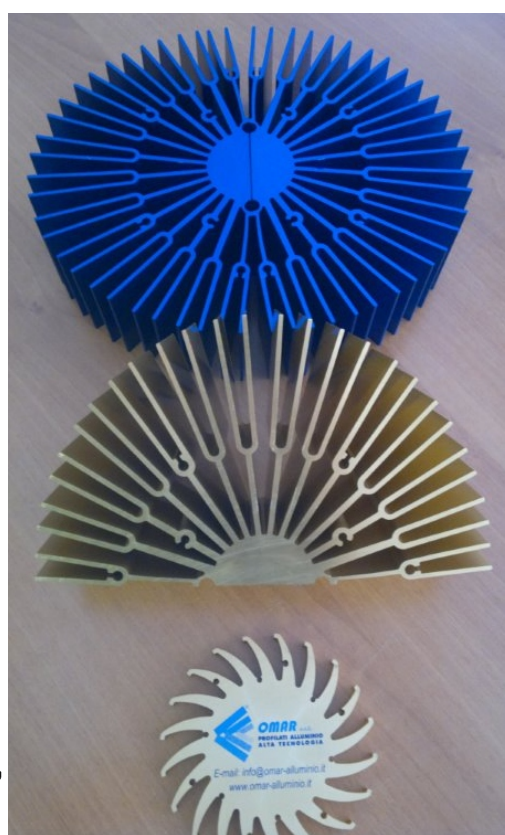

Cataloghi Online: www.omar-alluminio.it

www.omar-alluminio.com

PROFILATI ALLUMINIO A DISEGNO / STANDARD / SPECIALI / E PER:

ELETTRONICA / LED / FOTOVOLTAICO / AUTOMAZIONE ROBOTICA / PNEUMATICA / AUTOMOTIVE



Via Newton, n.12

20016 Pero (Milano - Italy)

Tel. +39 02 3535955 r.a. Fax. +39 02 3539929

E-Mail: info@omar-alluminio.it

Dissipatori di calore tondi in alluminio per illuminazione a Led



Via Newton, n.12
 20016 Pero (Milano - Italy)
 Tel. +39 02 3535955 r.a. Fax. +39 02 3539929
 E.Mail: info@omar-alluminio.it

Cataloghi Online: www.omar-alluminio.it
www.omar-alluminio.com

PROFILATI ALLUMINIO A DISEGNO / STANDARD / SPECIALI / E PER:
 ELETTRONICA / LED / FOTOVOLTAICO / AUTOMAZIONE ROBOTICA / PNEUMATICA / AUTOMOTIVE

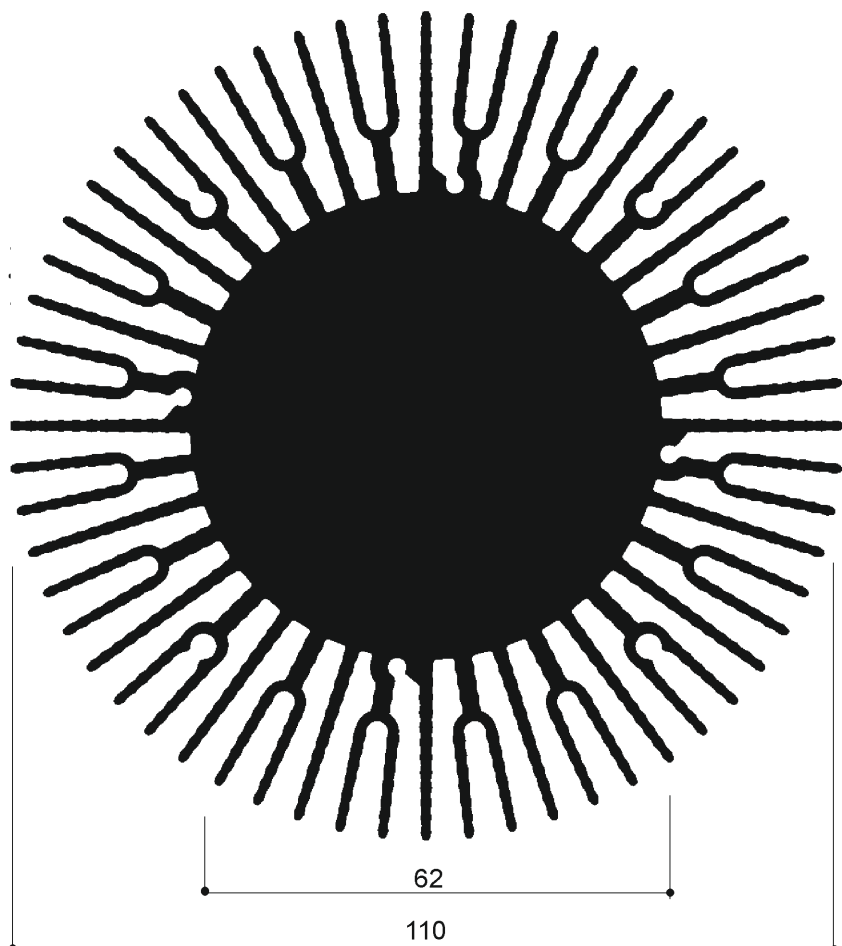

513

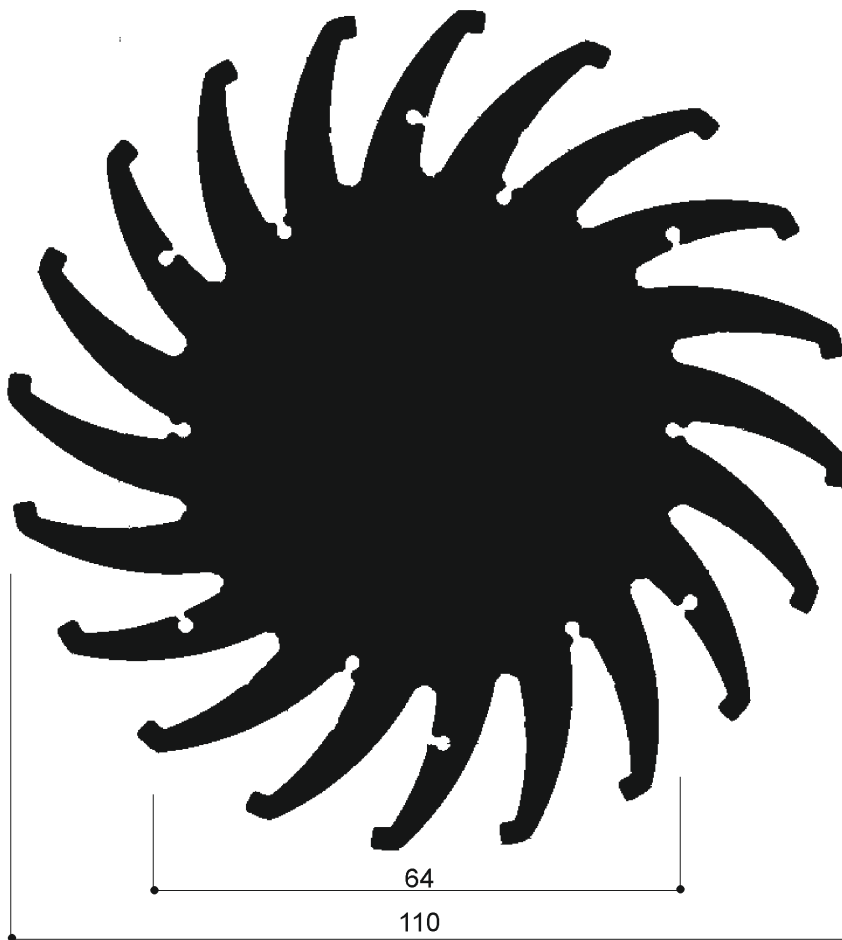

Dissipatori di calore in alluminio per illuminazione a Led

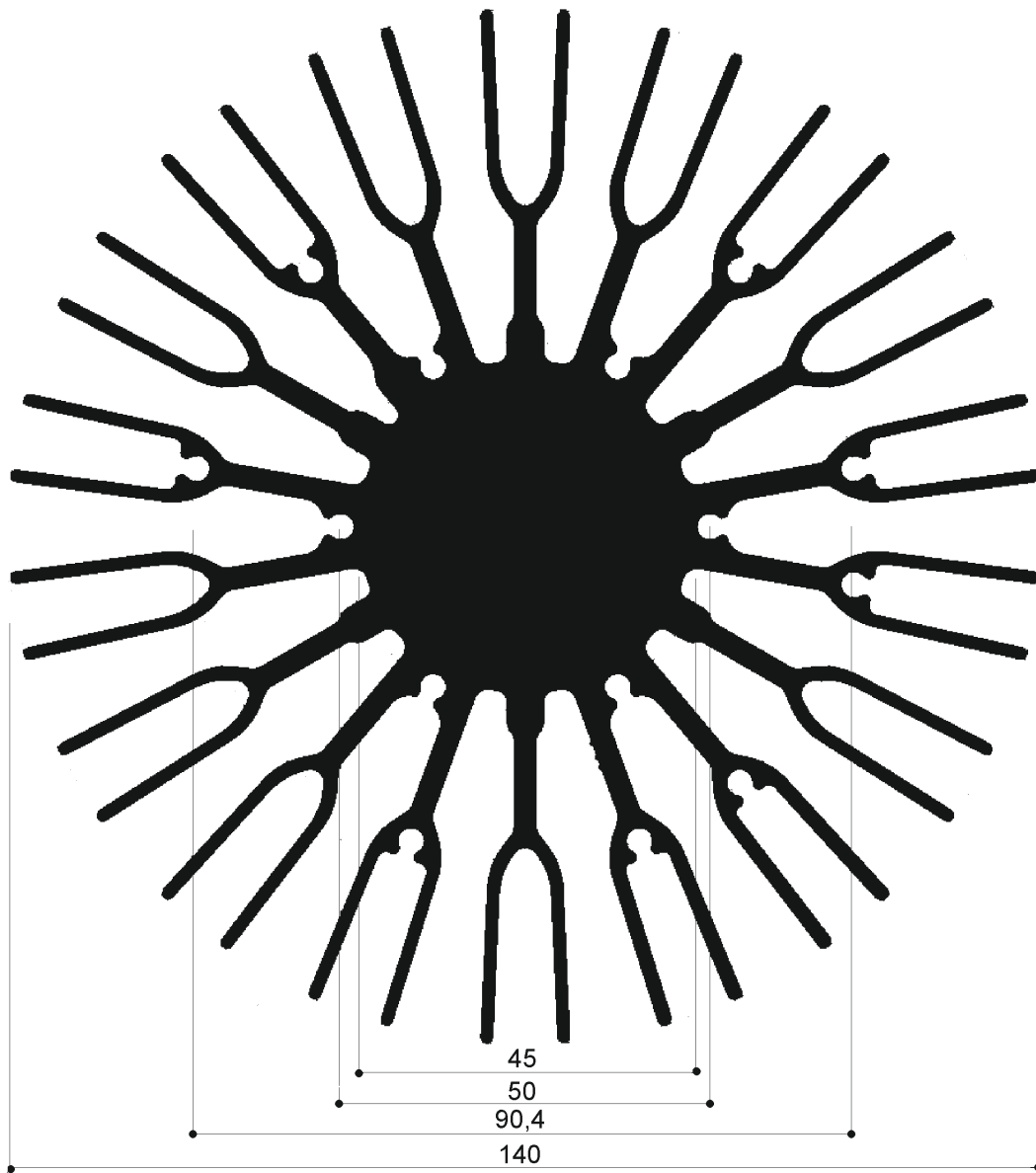

530

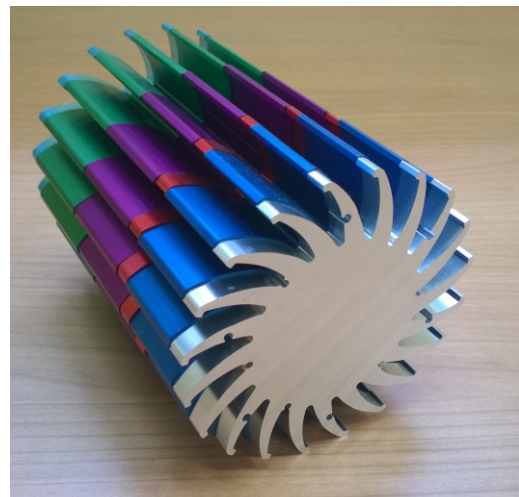
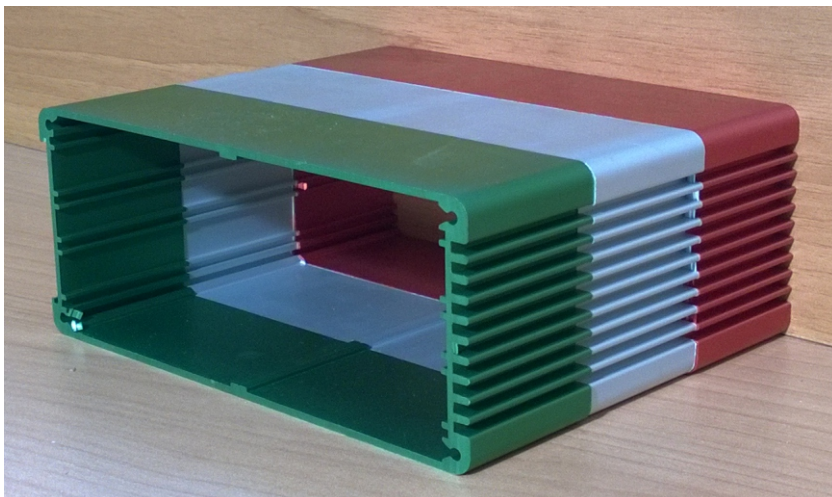

Cataloghi Online: www.omar-alluminio.it

www.omar-alluminio.com

PROFILATI ALLUMINIO A DISEGNO / STANDARD / SPECIALI / E PER:

ELETTRONICA / LED / FOTOVOLTAICO / AUTOMAZIONE ROBOTICA / PNEUMATICA / AUTOMOTIVE

Via Newton, n.12

20016 Pero (Milano - Italy)

Tel. +39 02 3535955 r.a. Fax. +39 02 3539929

E-Mail: info@omar-alluminio.it



Dissipatori di calore in alluminio per illuminazione a Led



Via Newton, n.12
20016 Pero (Milano - Italy)
Tel. +39 02 3535955 r.a. Fax. +39 02 3539929
E.Mail: info@omar-alluminio.it

Cataloghi Online: www.omar-alluminio.it
www.omar-alluminio.com

PROFILATI ALLUMINIO A DISEGNO / STANDARD / SPECIALI / E PER:
ELETTRONICA / LED / FOTOVOLTAICO / AUTOMAZIONE ROBOTICA / PNEUMATICA / AUTOMOTIVE

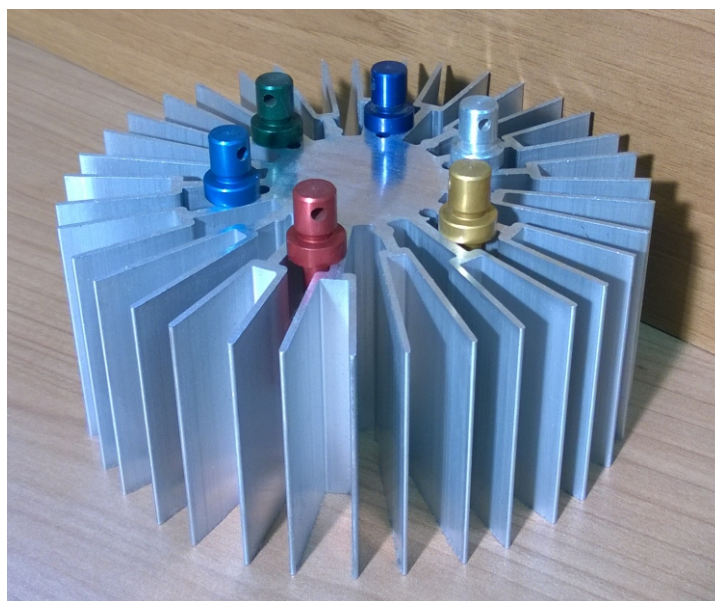
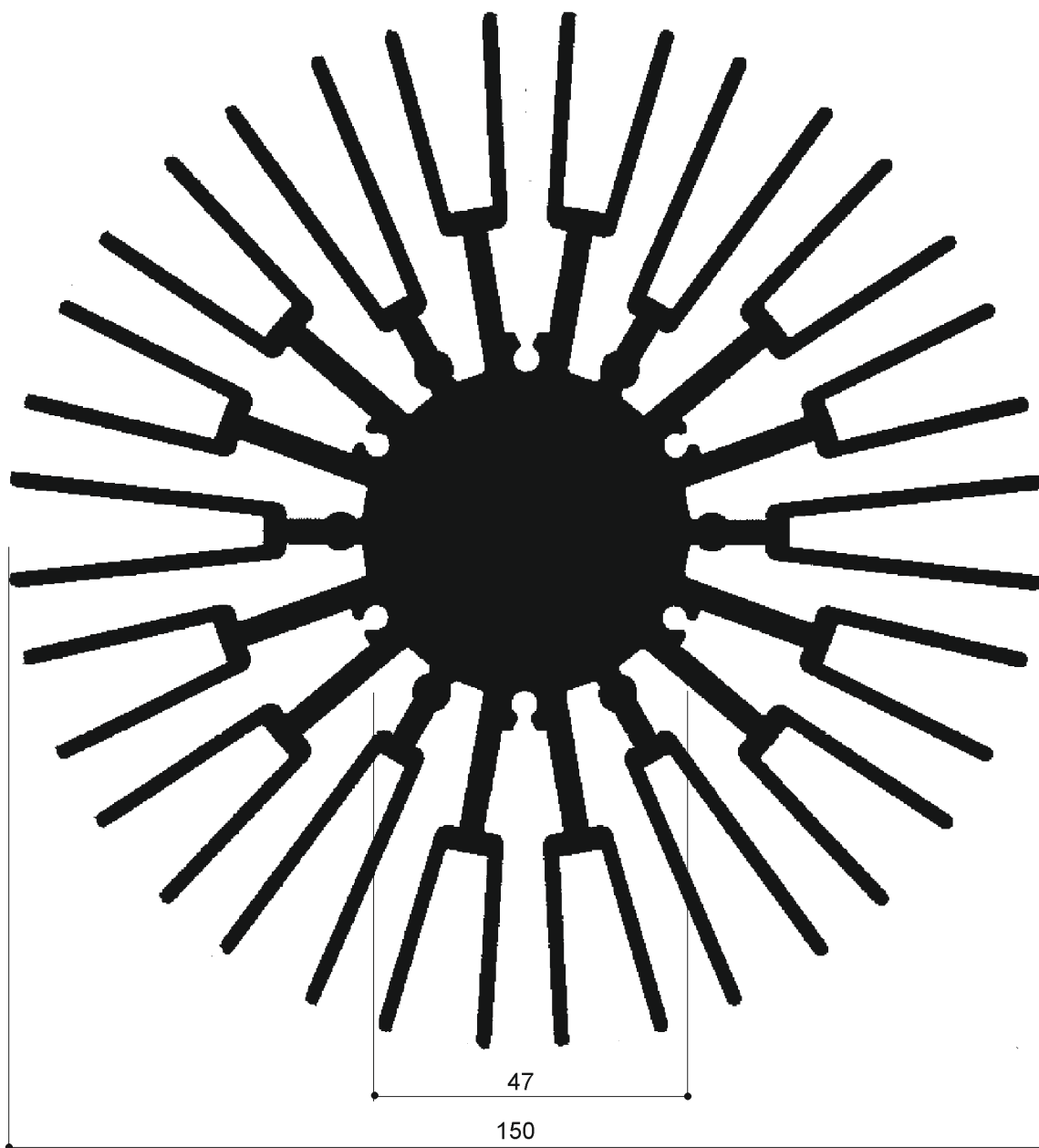

Dissipatori di calore in alluminio per illuminazione a Led



DISEGNI AL VERO (1:1)- SCALE 1:1

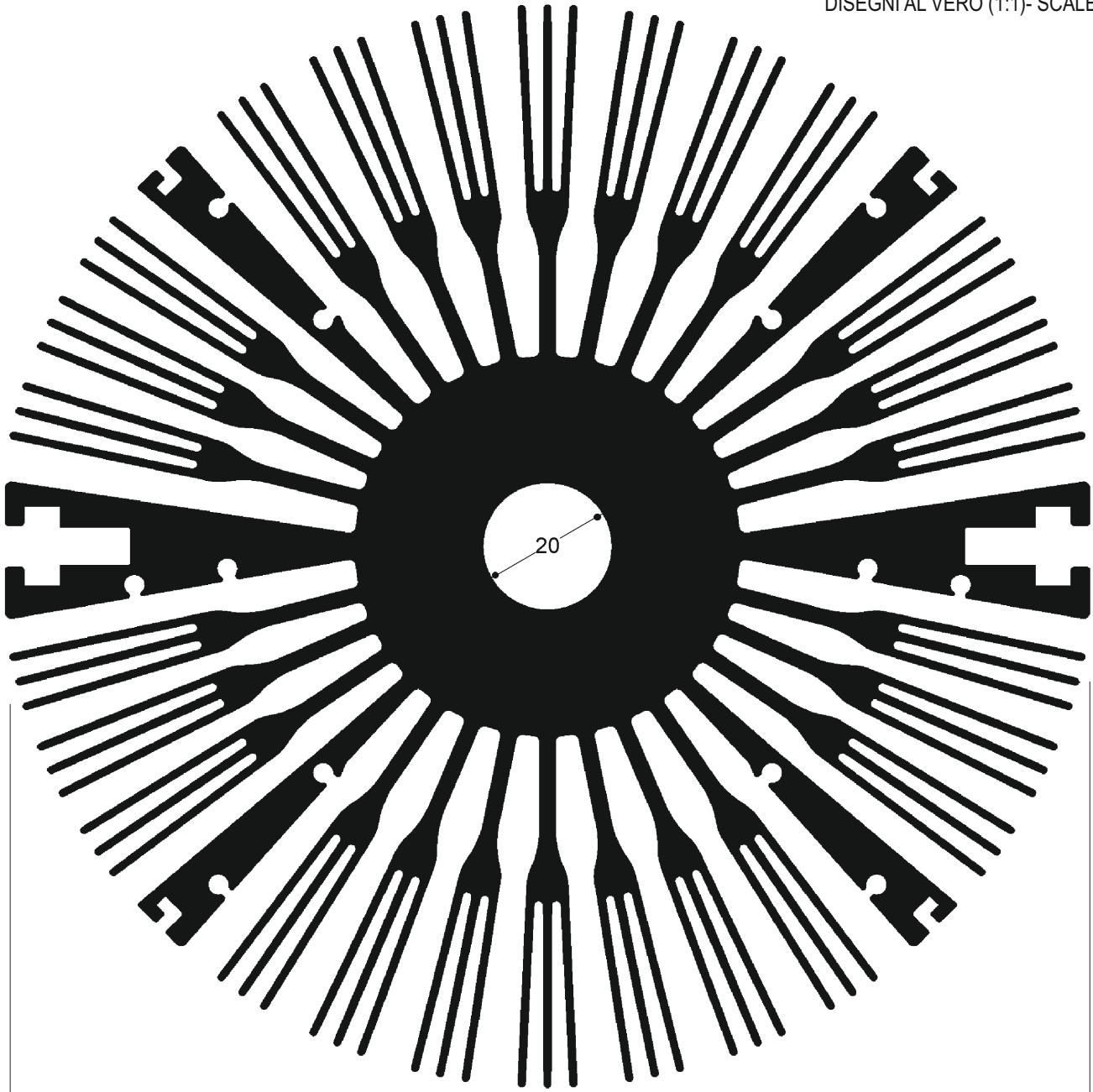

171

517

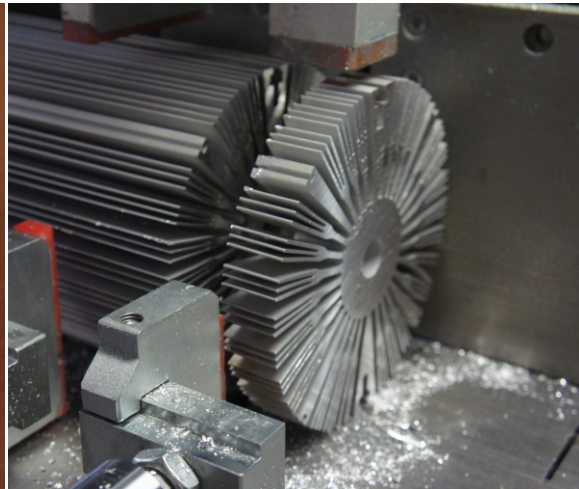
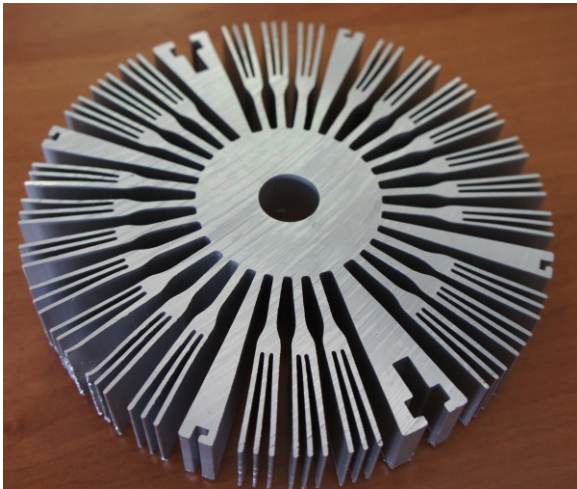

-RIPRODUZIONE VIETATA-
AGGIORNAMENTO CONTINUO - ED. DEL 05-2015

Cataloghi Online: www.omar-alluminio.it

www.omar-alluminio.com

PROFILATI ALLUMINIO A DISEGNO / STANDARD / SPECIALI / E PER:

ELETTRONICA / LED / FOTOVOLTAICO / AUTOMAZIONE ROBOTICA / PNEUMATICA / AUTOMOTIVE

Via Newton, n.12

20016 Pero (Milano - Italy)

Tel. +39 02 3535955 r.a. Fax. +39 02 3539929

E-Mail: info@omar-alluminio.it



Dissipatori di calore in alluminio per illuminazione a Led

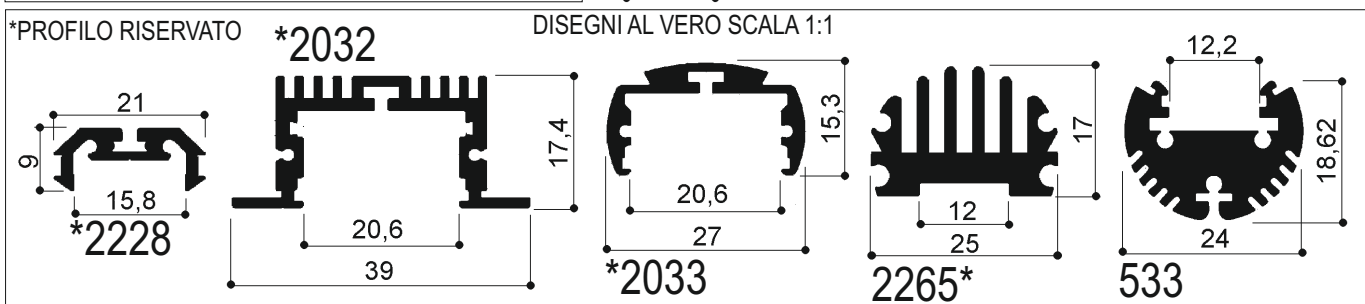
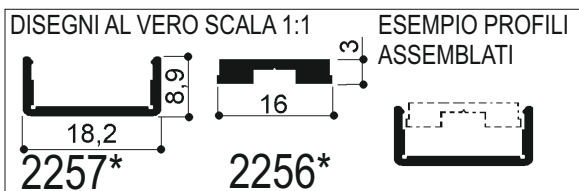
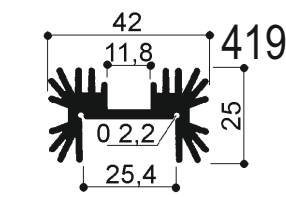
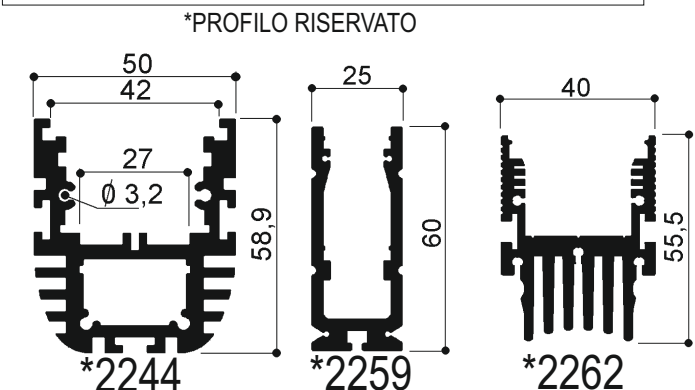
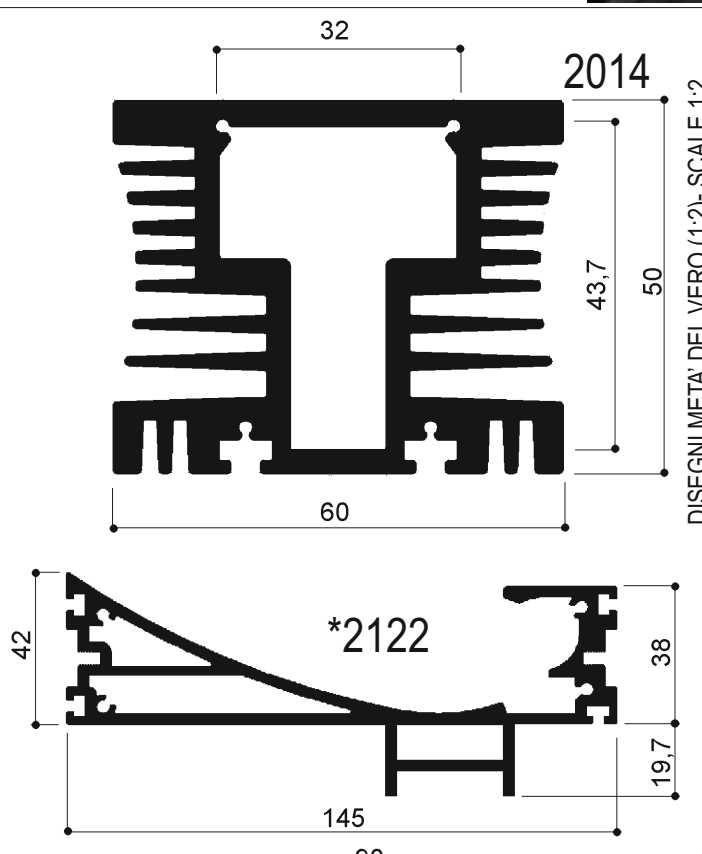
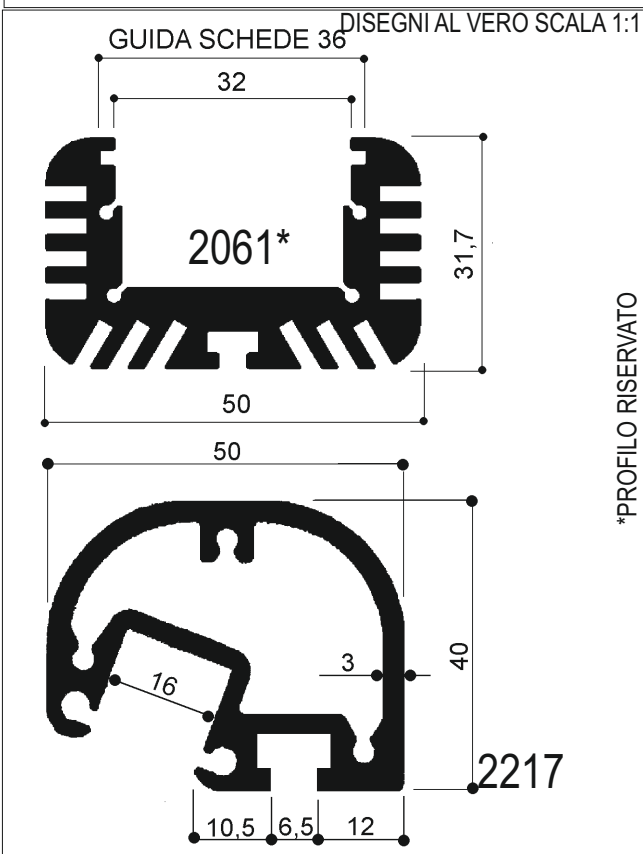
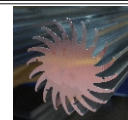

Cataloghi Online: www.omar-alluminio.it

www.omar-alluminio.com

PROFILATI ALLUMINIO A DISEGNO / STANDARD / SPECIALI / E PER:

ELETTRONICA / LED / FOTOVOLTAICO / AUTOMAZIONE ROBOTICA / PNEUMATICA / AUTOMOTIVE

Via Newton, n. 12

20016 Pero (Milano - Italy)

Tel. +39 02 3535955 r.a. Fax. +39 02 3539929

E-Mail: info@omar-alluminio.it



Dissipatori di calore in alluminio per illuminazione a Led

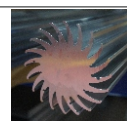

DISEGNI AL VERO SCALA 1:1

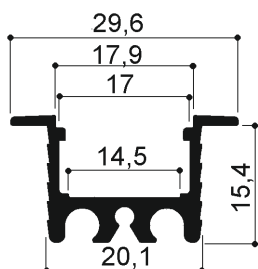

526

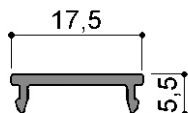

COV526

ESEMPIO PROFILI ASSEMBLATI

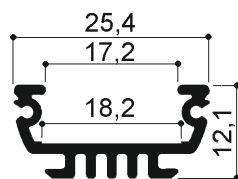

527

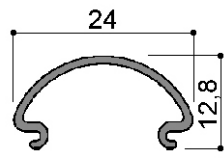

COV527

ESEMPIO PROFILI ASSEMBLATI

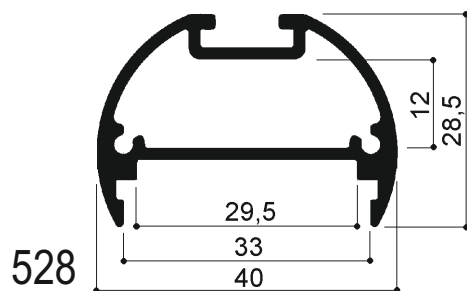
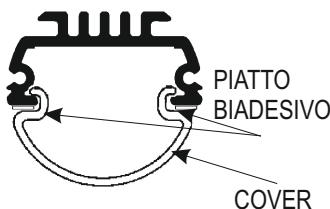

528

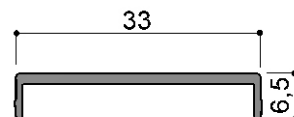

COV528

ESEMPIO PROFILI ASSEMBLATI

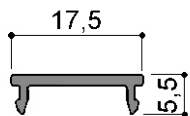
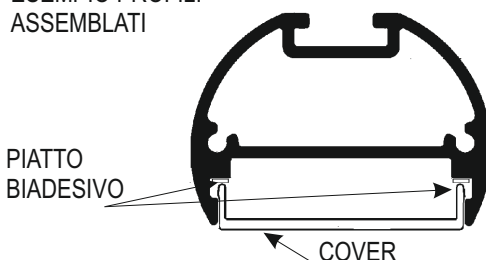

COV526 cover in policarbonato autoestinguente

- COV526-PT: cover trasparente
- COV526-PO: cover opale
- COV526-PST: cover satinato trasparente
- COV526-PSO: cover satinato opale

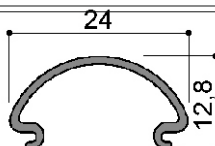

COV527 cover in policarbonato autoestinguente

- COV527-PT: cover trasparente
- COV527-PO: cover opale
- COV527-PST: cover satinato trasparente
- COV527-PSO: cover satinato opale

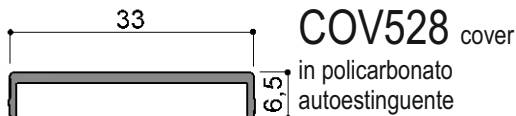

COV528 cover

in policarbonato autoestinguente

- COV528-PT: cover trasparente
- COV528-PO: cover opale
- COV528-PST: cover satinato trasparente
- COV528-PSO: cover satinato opale
- COV528-PTMIC: trasparente microprismato

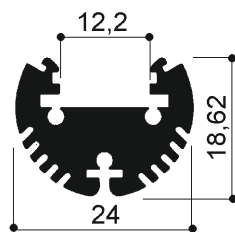

533



COV533 cover in policarbonato autoestinguente

COV533-PO: cover opale
COV533

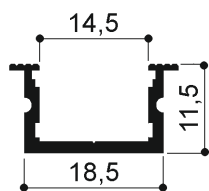

534

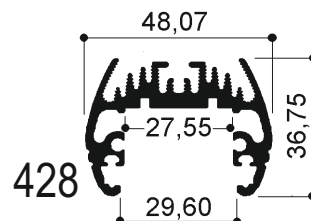

428



Profili in alluminio per STRISCE A LED

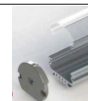

TAPPO CHIUSO IN ABS COLORE ARGENTO PER ART.526 COD.ART.: L-0001



TAPPO CON FORO PASSACAVO IN ABS COLORE ARGENTO PER ART.526 COD.ART.:L-0002



TAPPO CHIUSO IN ABS COLORE ARGENTO PER ART.527 COD.ART.: L-0006

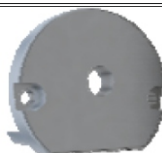

TAPPO CON FORO PASSACAVO IN ABS COLORE ARGENTO PER ART.527 COD.ART.: L-0007



STAFFA DI FISSAGGIO IN ABS COLORE ARGENTO ART.527 COD.ART.: L-0008



STAFFA DI FISSAGGIO ROTANTE REGOLABILE IN ABS COLORE ARGENTO ART.527 COD.ART.: L-0014



TAPPO CHIUSO IN ABS COLORE ARGENTO PER ART.528 COD.ART.:L-0010

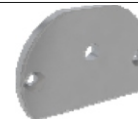

TAPPO CON FORO PASSACAVO IN ABS COLORE ARGENTO PER ART.528 COD.ART.: L-0010



KIT STAFFA PER FISSAGGIO A PARETE/SOSPENSIONE COLORE NERO PER ART.528 COD.ART.: L-0013



PASSA CAVO COD.ART.: L-0012



VITI AUTOFIETTANTI 2,9X9,5 PER FISSAGGIO TAPPO AL PROFILO FM526 E FM528
CONFEZIONI DA 100PZ COD.ART.: L-0005



VITI AUTOFIETTANTI 2x6 PER FISSAGGIO TAPPO AL PROFILO FM527
CONFEZIONI DA 100PZ COD.ART.: L-0009



TAPPO CHIUSO IN ALLUMINIO ANODIZZATO ARGENTO PER ART.533 COD.ART.:L-0015



TAPPO CON FORO PASSACAVO IN ALLUMINIO ANODIZZATO ARGENTO PER ART.528 COD.ART.: L-0016

Cataloghi Online: www.omar-alluminio.it

www.omar-alluminio.com

PROFILATI ALLUMINIO A DISEGNO / STANDARD / SPECIALI / E PER:

ELETTRONICA / LED / FOTOVOLTAICO / AUTOMAZIONE ROBOTICA / PNEUMATICA / AUTOMOTIVE



Via Newton, n.12

20016 Pero (Milano - Italy)

Tel. +39 02 3535955 r.a. Fax. +39 02 3539929

E-Mail: info@omar-alluminio.it

Profili in alluminio per STRISCE A LED ACCESSORI

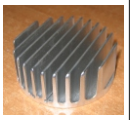

DISEGNI AL VERO (1:1) - SCALE 1:1

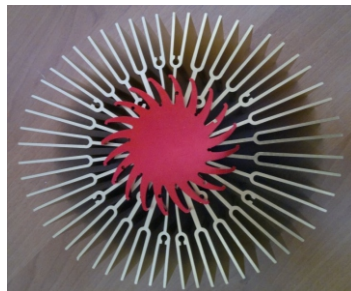
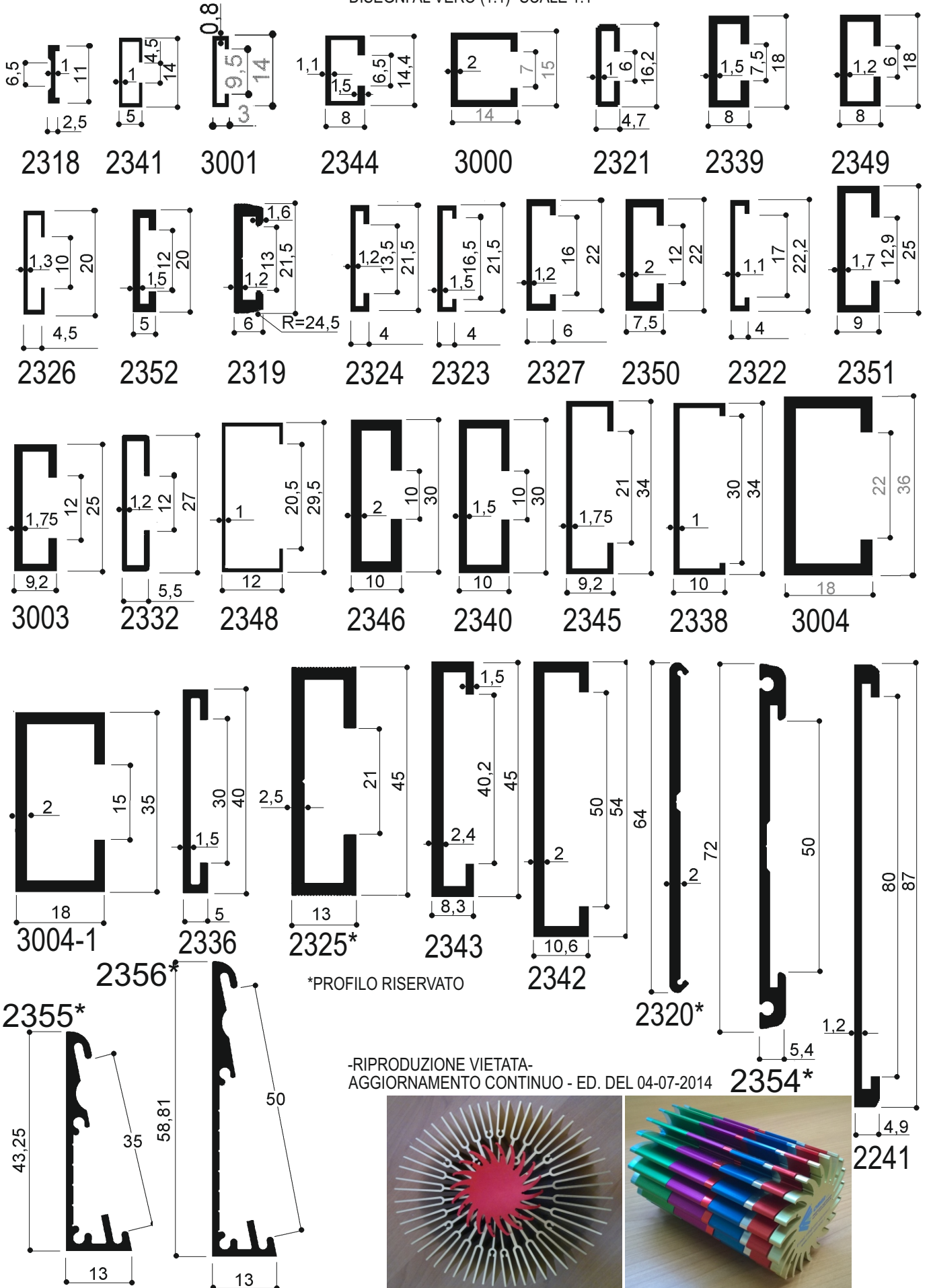

Via Newton, n.12

20016 Pero (Milano - Italy)

Tel. +39 02 3535955 r.a. Fax. +39 02 3539929

E-Mail: info@omar-alluminio.it

Cataloghi Online: www.omar-alluminio.it

www.omar-alluminio.com

PROFILATI ALLUMINIO A DISEGNO / STANDARD / SPECIALI / E PER:

ELETRONICA / LED / FOTOVOLTAICO / AUTOMAZIONE ROBOTICA / PNEUMATICA / AUTOMOTIVE



Dissipatori di calore in alluminio per illuminazione a Led



Dissipatori a pettine fresati tondi per LED
-solo fresatura in tondo con vari diametri -grezzi

DISEGNI META' DEL VERO (1:2)- SCALE 1:2

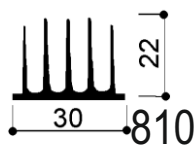

FRESATURA BARRA
DIAMETRO: 27/30mm

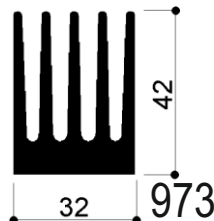
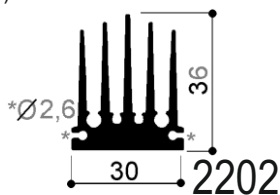

FRESATURA BARRA
DIAMETRO: da 27mm a 32mm

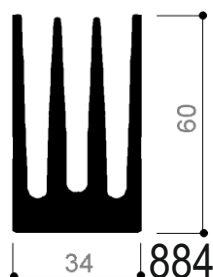
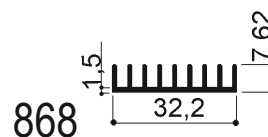

FRESATURA BARRA
DIAMETRO: 34mm

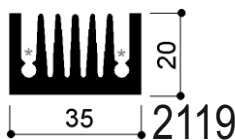

FRESATURA BARRA
DIAMETRO: 27/30/32/35mm

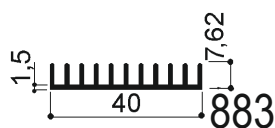
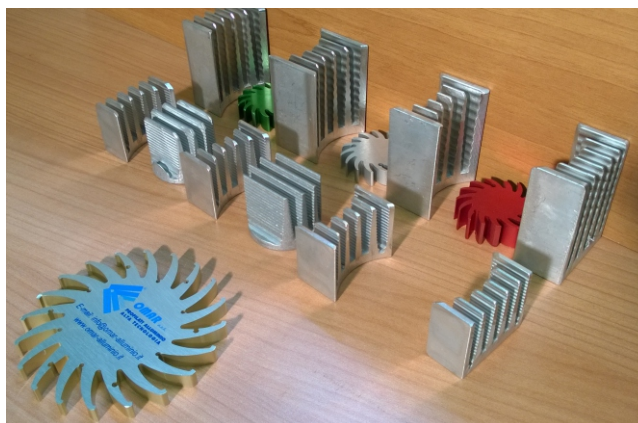

FRESATURA BARRA
DIAMETRO: da 27 a 41/42mm

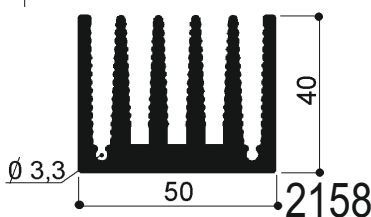
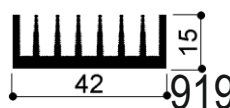
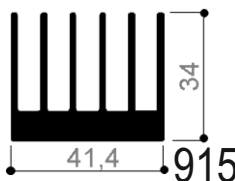

FRESATURA BARRA
DIAMETRO: da 27mm a 50/52mm

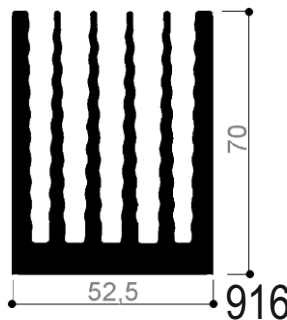
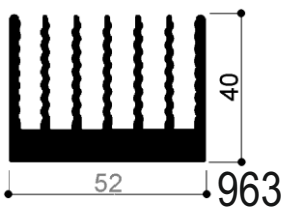

Pag.20L

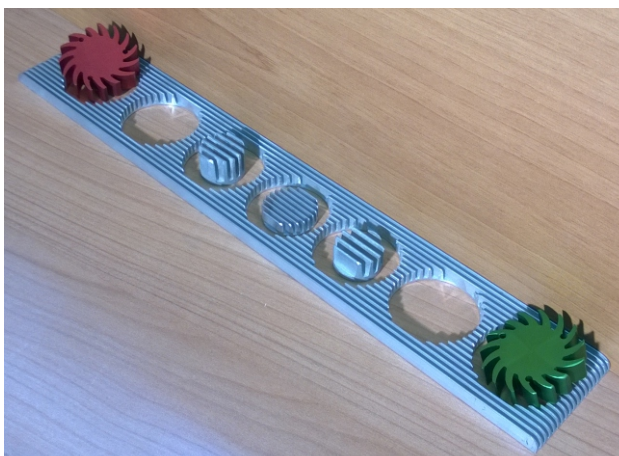
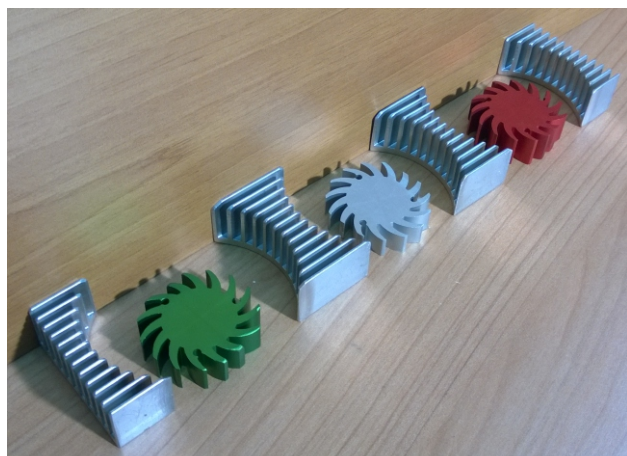

Via Newton, n.12

20016 Pero (Milano - Italy)

Tel. +39 02 3535955 r.a. Fax. +39 02 3539929

E-Mail: info@omar-alluminio.it

Cataloghi Online: www.omar-alluminio.it

www.omar-alluminio.com

PROFILATI ALLUMINIO A DISEGNO / STANDARD / SPECIALI / E PER:

ELETTRONICA / LED / FOTOVOLTAICO / AUTOMAZIONE ROBOTICA / PNEUMATICA / AUTOMOTIVE



Dissipatori di calore in alluminio per illuminazione a Led

Dissipatori a pettine fresati tonde per LED
-solo fresatura in tondo con vari diametri -grezzi



DISEGNI META' DEL VERO (1:2)- SCALE 1:2

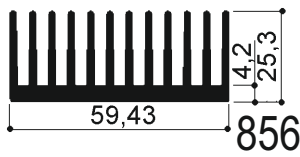

FRESATURA BARRA
DIAMETRO: da 27mm a 60/66mm

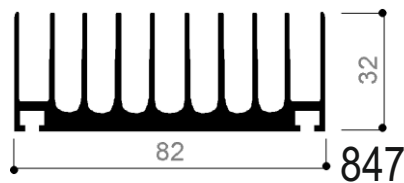
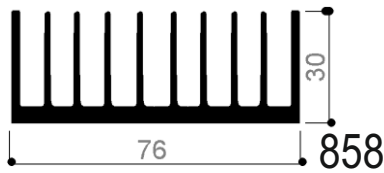
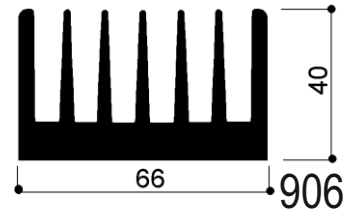
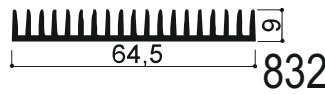

FRESATURA BARRA
DIAMETRO: da 40mm a 76/80/82/84mm

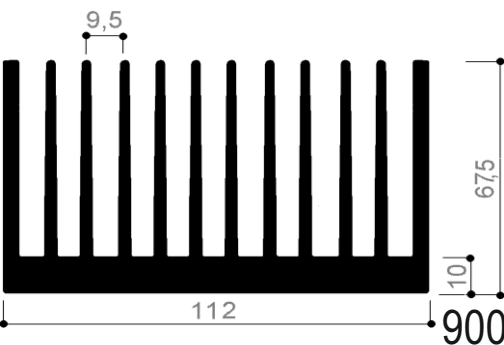
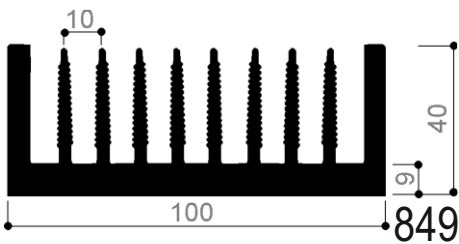
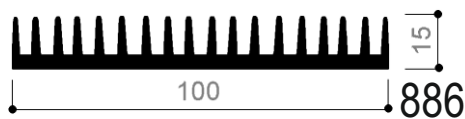

FRESATURA BARRA
DIAMETRO: da 40mm a 112/114mm

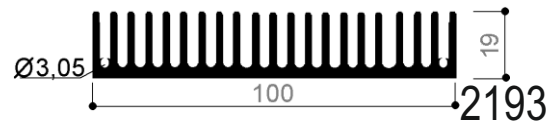
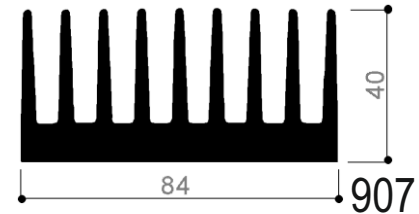
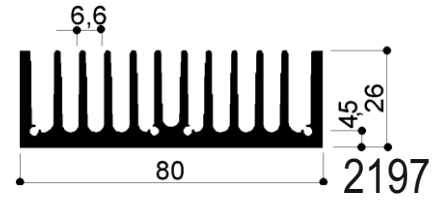

FRESATURA BARRA
DIAMETRO: da 40mm a 100mm

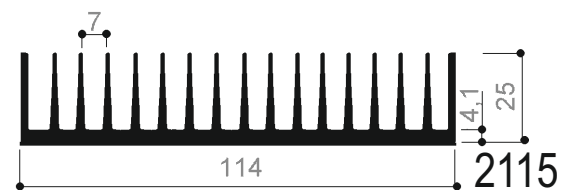
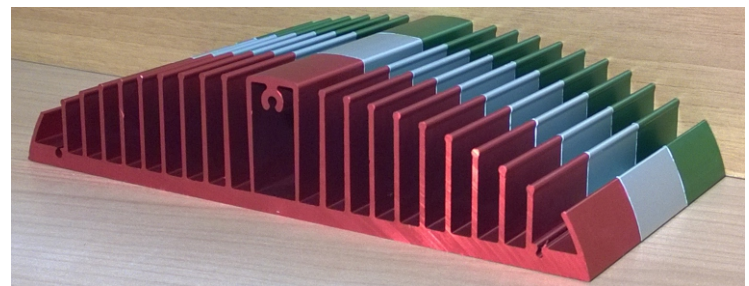

Via Newton, n.12
20016 Pero (Milano - Italy)
Tel.+39 02 3535955 r.a. Fax.+39 02 3539929
E-Mail: info@omar-alluminio.it

Cataloghi Online: www.omar-alluminio.it
www.omar-alluminio.com
PROFILATI ALLUMINIO A DISEGNO / STANDARD / SPECIALI / E PER:
ELETTRONICA / LED / FOTOVOLTAICO / AUTOMAZIONE ROBOTICA / PNEUMATICA / AUTOMOTIVE



Dissipatori di calore in alluminio per illuminazione a Led

Dissipatori a pettine fresati tonde per LED
-solo fresatura in tondo con vari diametri -grezzi



DISEGNI META' DEL VERO (1:2)- SCALE 1:2

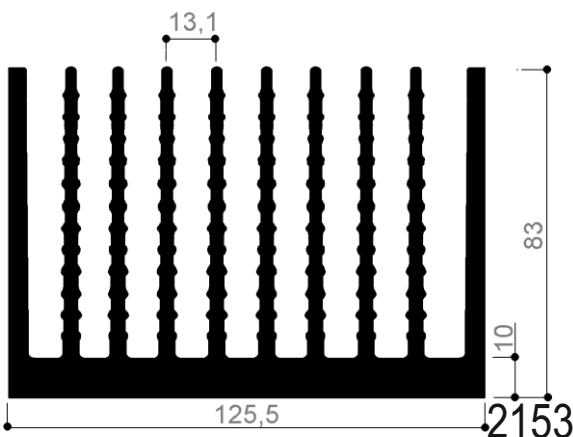
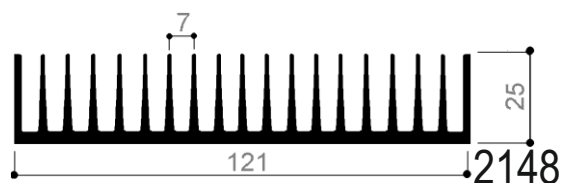
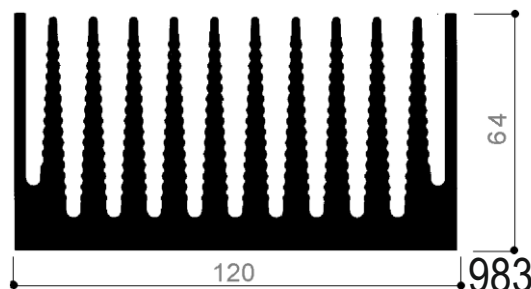
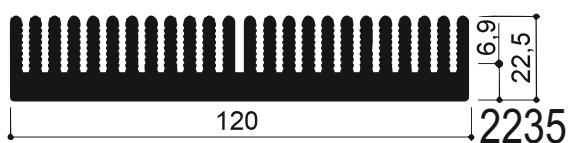

FRESATURA BARRA

DIAMETRO: da 40mm a 120/121/125mm

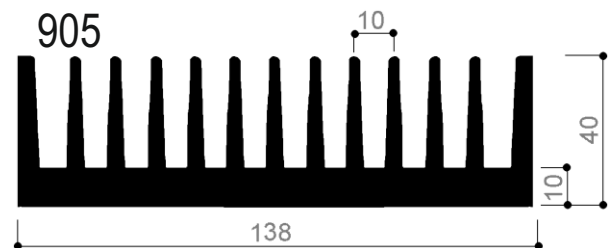
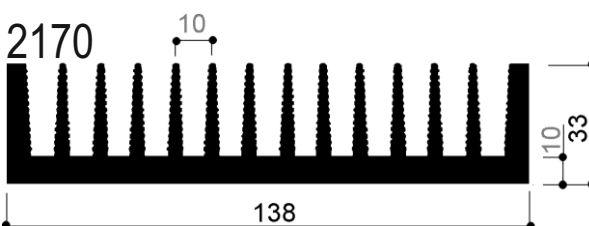
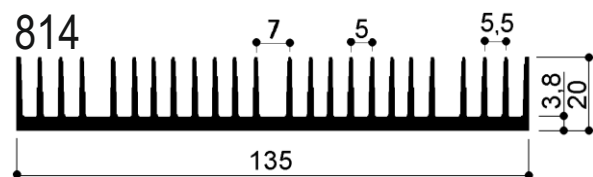

FRESATURA BARRA

DIAMETRO: da 40mm a 120/125/135/138mm

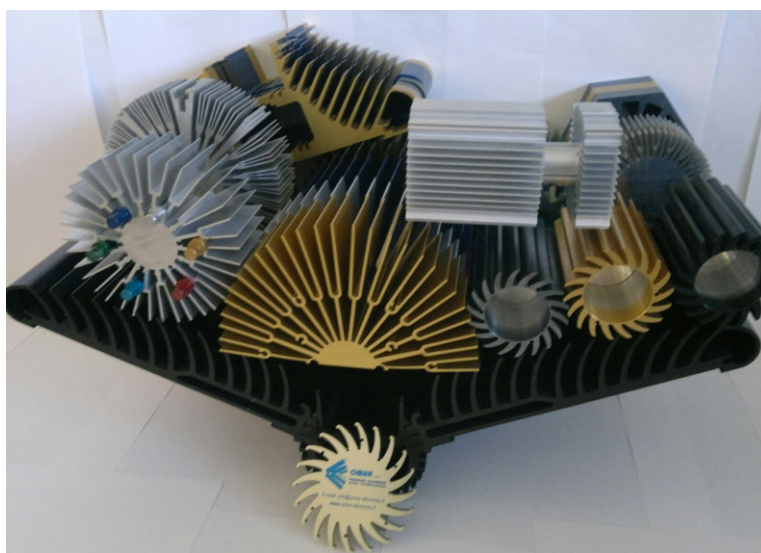

Via Newton, n.12

20016 Pero (Milano - Italy)

Tel. +39 02 3535955 r.a. Fax. +39 02 3539929

E-Mail: info@omar-alluminio.it

Cataloghi Online: www.omar-alluminio.it

www.omar-alluminio.com

PROFILATI ALLUMINIO A DISEGNO / STANDARD / SPECIALI / E PER:

ELETTRONICA / LED / FOTOVOLTAICO / AUTOMAZIONE ROBOTICA / PNEUMATICA / AUTOMOTIVE

-RIPRODUZIONE VIETATA-
AGGIORNAMENTO CONTINUO - ED. DEL 05-2015



Dissipatori di calore in alluminio per illuminazione a Led

Dissipatori a pettine fresati tondi per LED
-solo fresatura in tondo con vari diametri -grezzi



DISEGNI META' DEL VERO (1:2)- SCALE 1:2

FRESATURA BARRA

DIAMETRO: da 40mm a 150/158/160mm

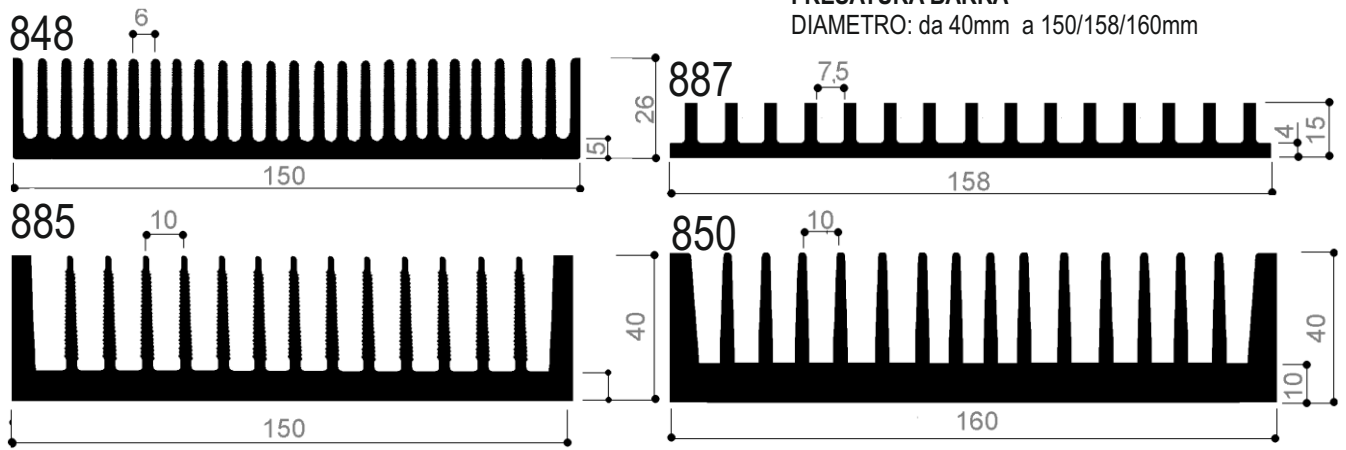

FRESATURA BARRA

DIAMETRO: da 40mm a 197/200mm

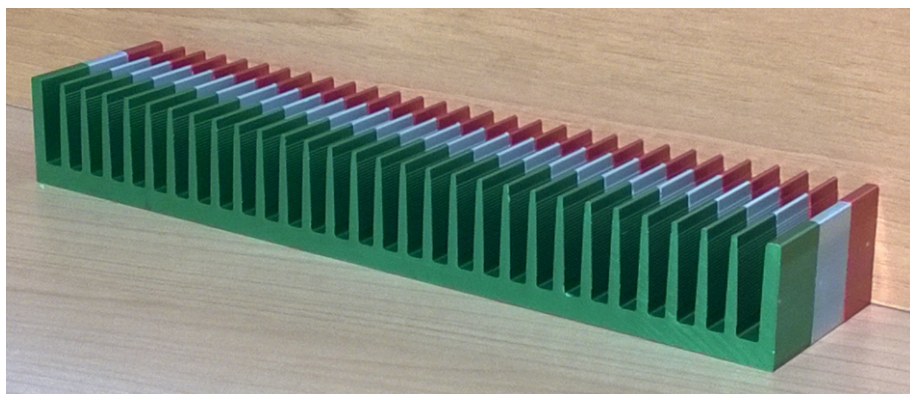
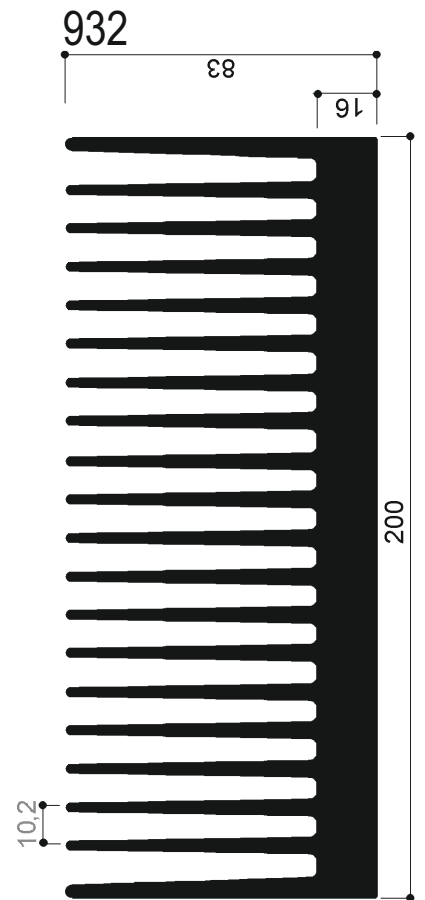
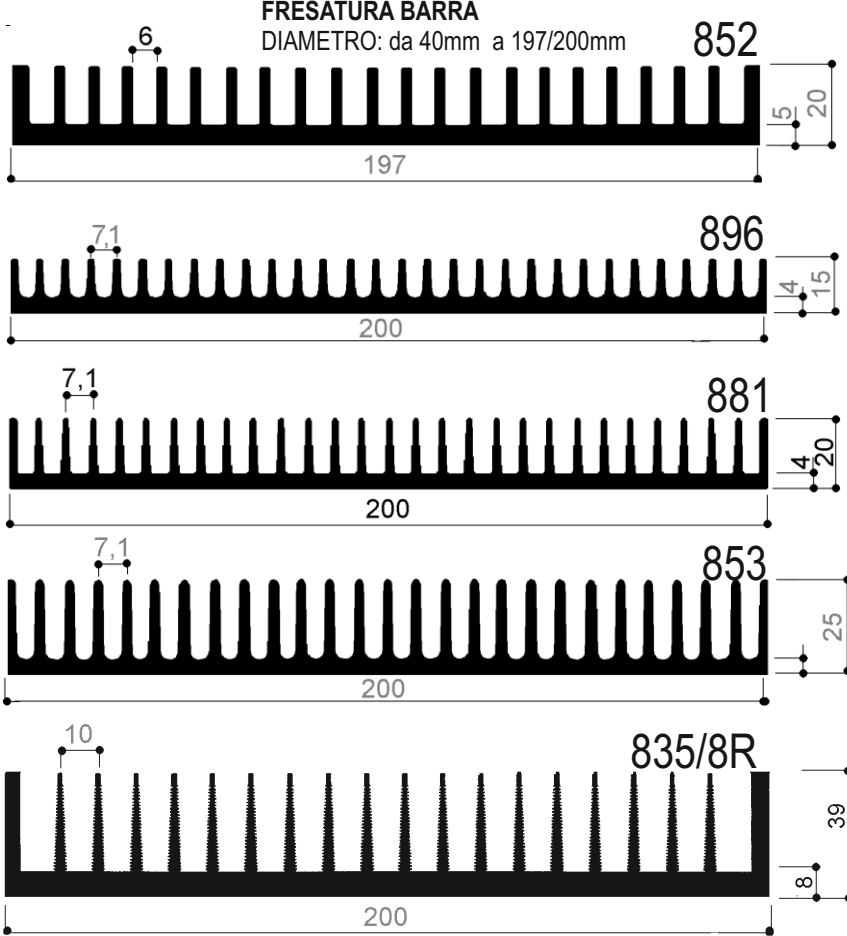

Via Newton, n.12
20016 Pero (Milano - Italy)
Tel. +39 02 3535955 r.a. Fax. +39 02 3539929
E-Mail: info@omar-alluminio.it

Cataloghi Online: www.omar-alluminio.it
www.omar-alluminio.com
PROFILATI ALLUMINIO A DISEGNO / STANDARD / SPECIALI / E PER:
ELETTRONICA / LED / FOTOVOLTAICO / AUTOMAZIONE ROBOTICA / PNEUMATICA / AUTOMOTIVE

-RIPRODUZIONE VIETATA-
AGGIORNAMENTO CONTINUO - ED. DEL 05-2015

Dissipatori di calore in alluminio per illuminazione a Led

Dissipatori a pettine fresati tonde per LED
-solo fresatura in tondo con vari diametri -grezzi



DISEGNI META' DEL VERO (1:2)- SCALE 1:2

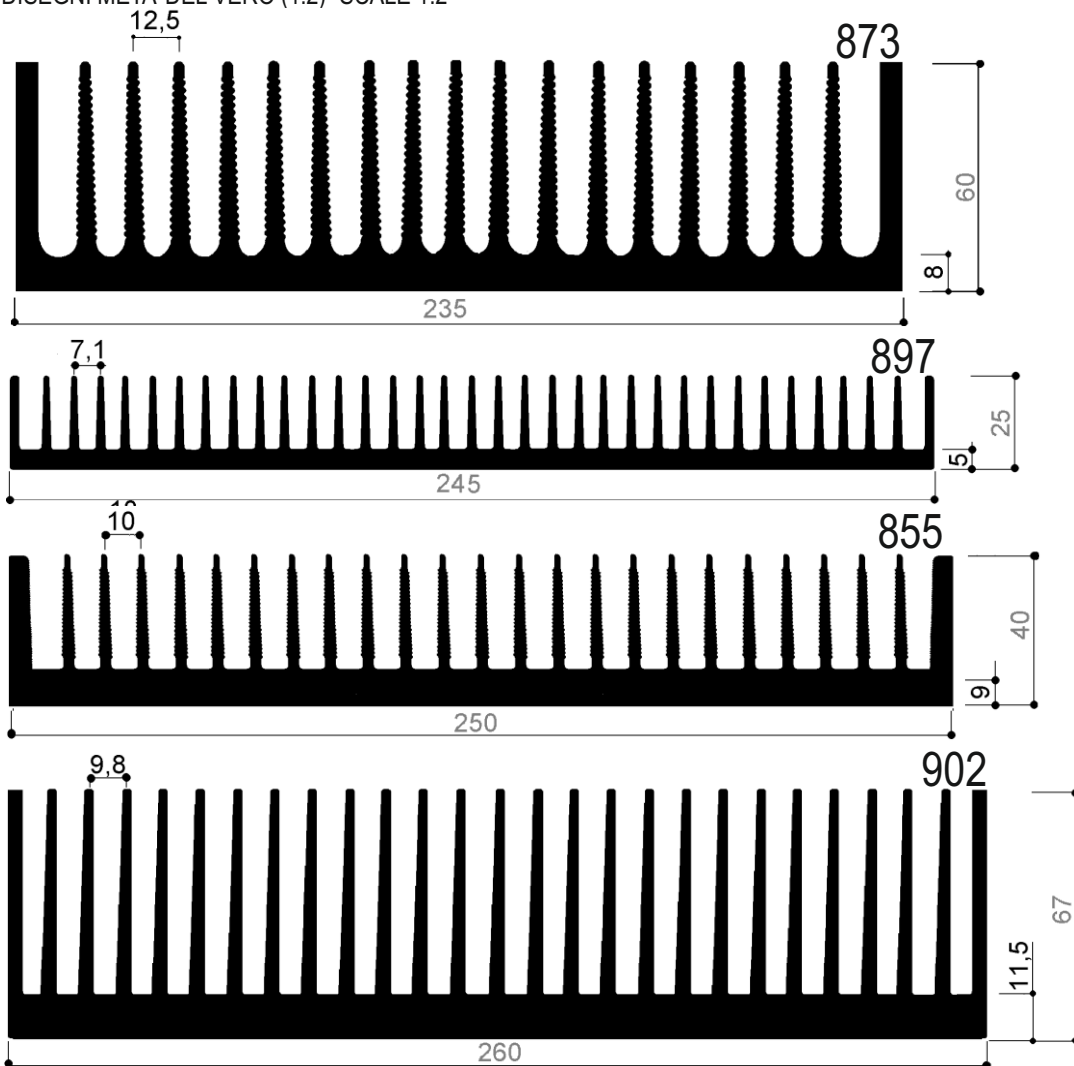

FRESATURA BARRA

DIAMETRO: da 40mm a 235/245/260mm

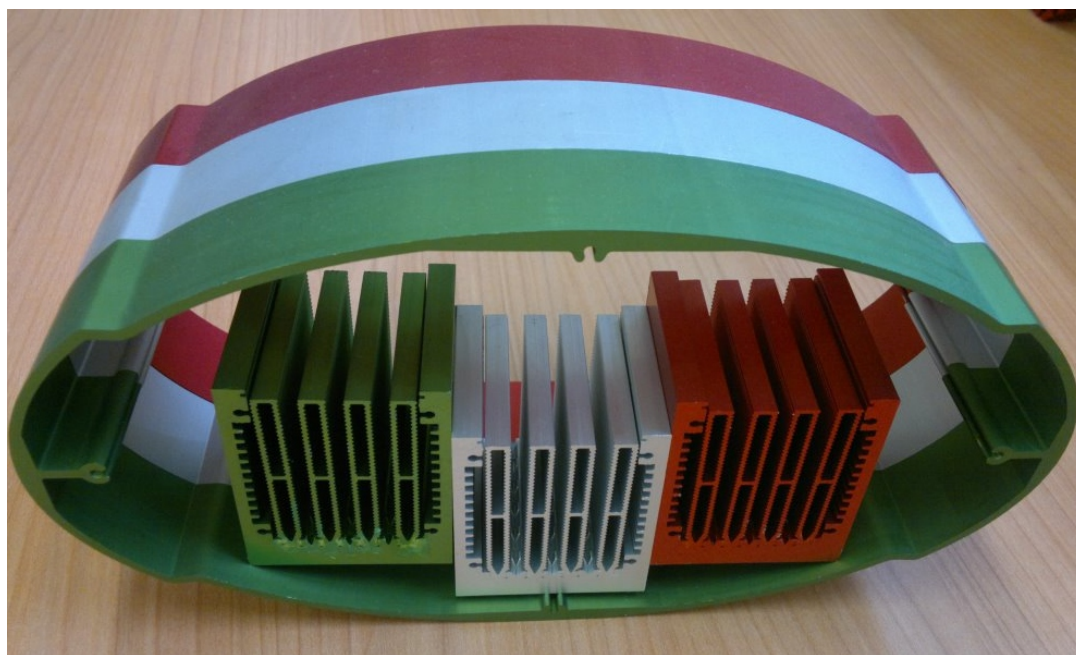

Cataloghi Online: www.omar-alluminio.it

www.omar-alluminio.com

PROFILATI ALLUMINIO A DISEGNO / STANDARD / SPECIALI / E PER:

ELETTRONICA / LED / FOTOVOLTAICO / AUTOMAZIONE ROBOTICA / PNEUMATICA / AUTOMOTIVE

Via Newton, n.12

20016 Pero (Milano - Italy)

Tel. +39 02 3535955 r.a. Fax. +39 02 3539929

E-Mail: info@omar-alluminio.it

-RIPRODUZIONE VIETATA-
-RIPRODUZIONE VIETATA- AGGIORNAMENTO CONTINUO - ED. DEL 05-2015



Dissipatori di calore in alluminio per illuminazione a Led

Dissipatori a pettine fresati tonde per LED
-solo fresatura in tondo con vari diametri -grezzi



Via Newton, n.12
20016 Pero (Milano - Italy)
Tel. +39 02 3535955 r.a. Fax. +39 02 3539929
E.Mail: info@omar-alluminio.it

Cataloghi Online: www.omar-alluminio.it
www.omar-alluminio.com

PROFILATI ALLUMINIO A DISEGNO / STANDARD / SPECIALI / E PER:
ELETTRONICA / LED / FOTOVOLTAICO / AUTOMAZIONE ROBOTICA / PNEUMATICA / AUTOMOTIVE

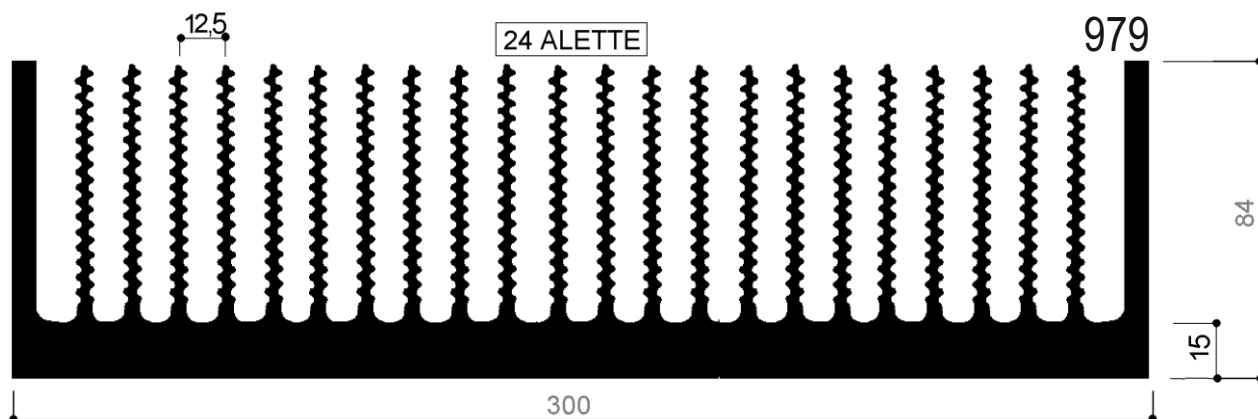
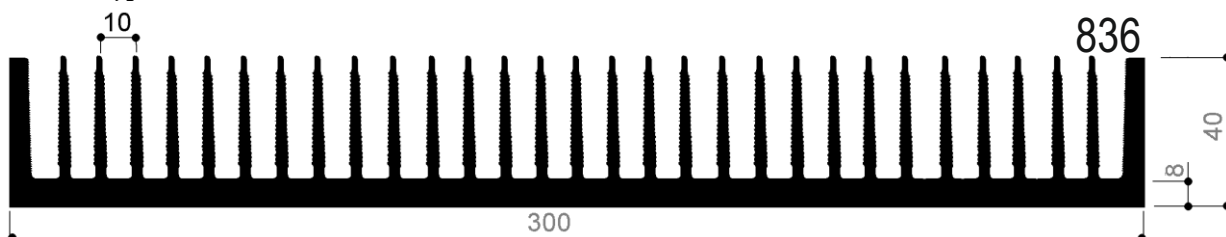
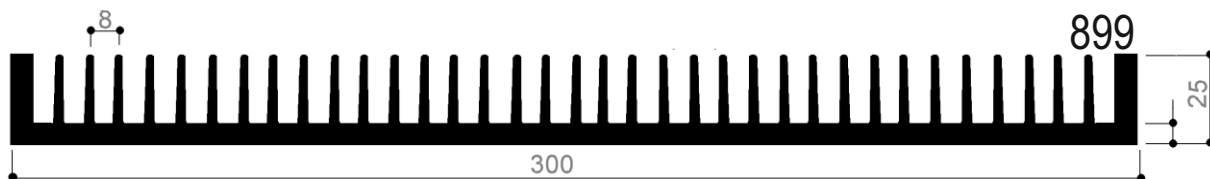

FRESATURA BARRA

DIAMETRO: da 40mm a 300mm

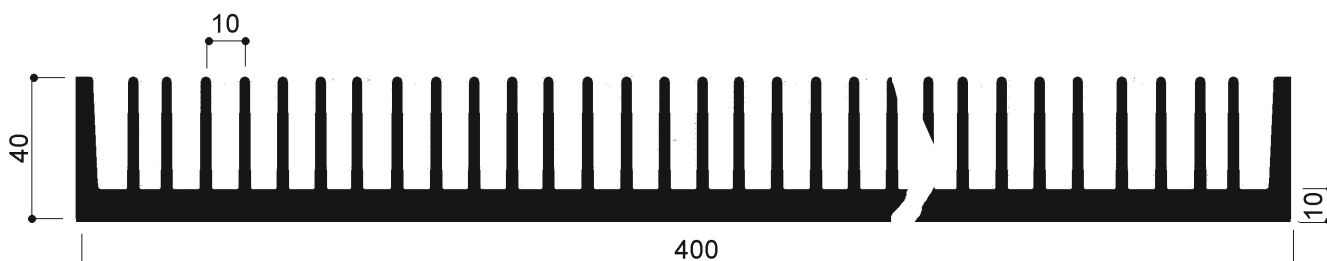

FRESATURA BARRA

DIAMETRO: da 40mm a 400mm

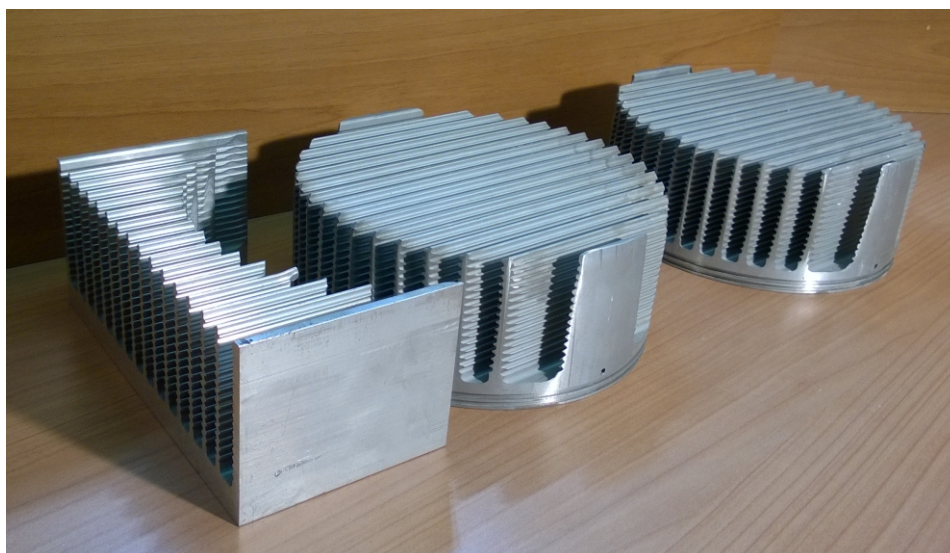

Dissipatori di calore per sorgenti luminose a LED

Illuminazione allo stato solido - LED

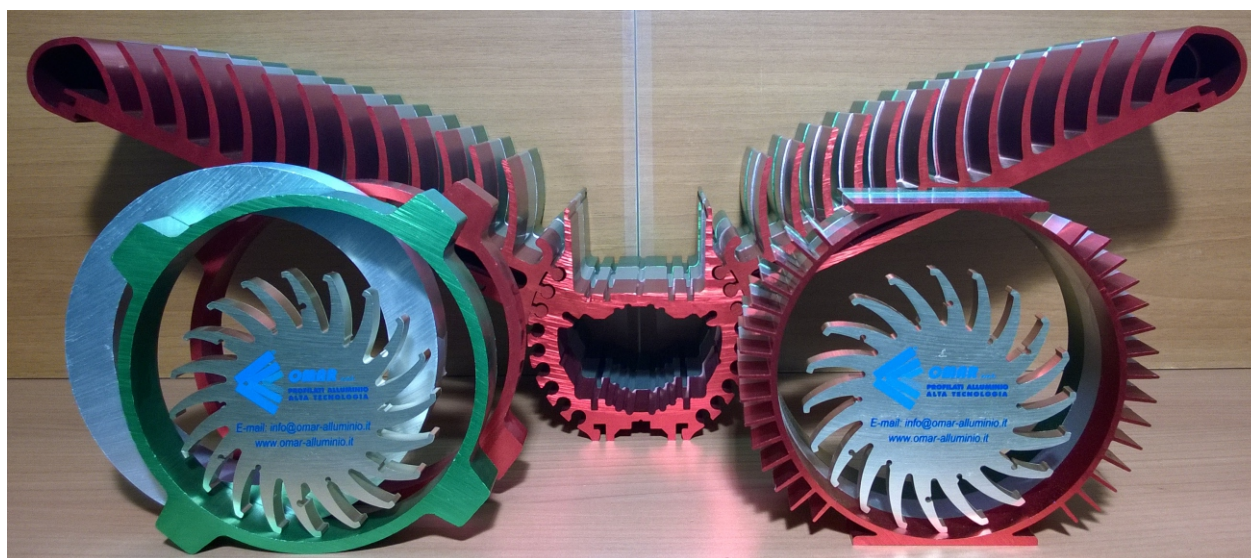
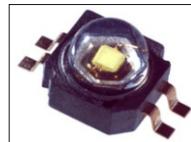

OLTRE AI PROFILI RIPORTATI A CATALOGO SIAMO IN GRADO DI FORNIRE DISSIPATORI IN BARRE CON SAGOME 'CUSTOM' ANCHE PER MODESTI QUANTITATIVI.

TUTTI I PROFILI SONO FORNIBILI NEI SEGUENTI FORMATI:

- BARRE DA 3 / 4 METRI
 - TAGLIATI A MISURA (GREZZI/OSSIDATI)
 - COMPLETAMENTE LAVORATI SECONDO VS. DISEGNO
- WE ARE ABLE TO SUPPLY:
- CUSTOM SECTIONS ALSO FOR LITTLE QUANTITY
 - CUSTOM DRILLINGS

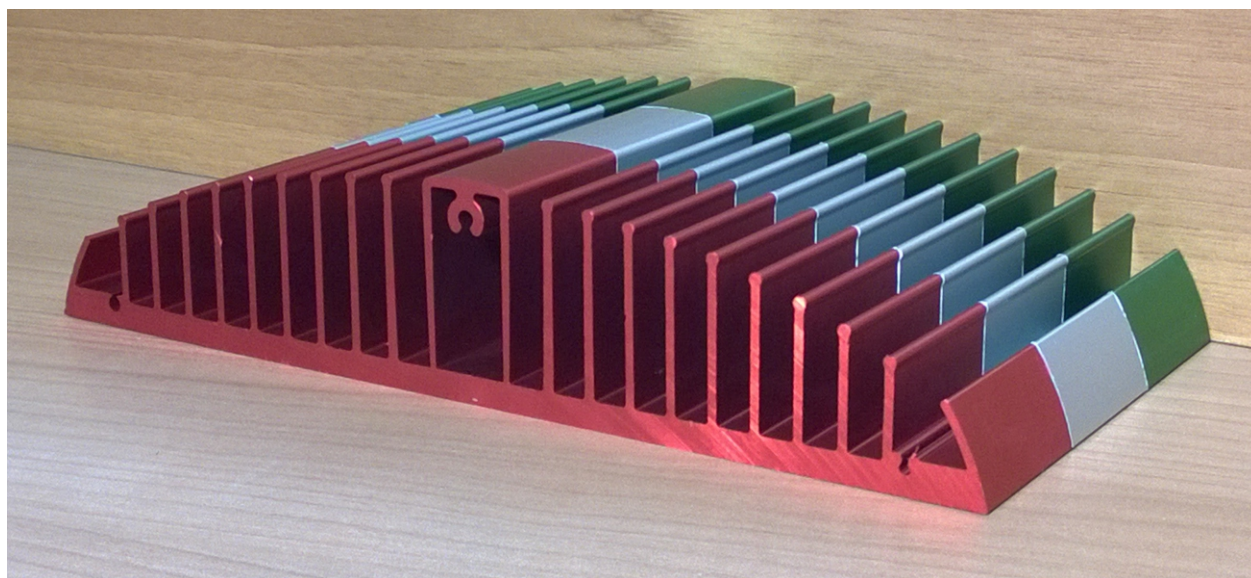

Cataloghi Online: www.omar-alluminio.it

www.omar-alluminio.com

PROFILATI ALLUMINIO A DISEGNO / STANDARD / SPECIALI / E PER:

ELETTRONICA / LED / FOTOVOLTAICO / AUTOMAZIONE ROBOTICA / PNEUMATICA / AUTOMOTIVE



Via Newton, n.12

20016 Pero (Milano - Italy)

Tel. +39 02 3535955 r.a. Fax. +39 02 3539929

E-Mail: info@omar-alluminio.it

FIERA MILANO RHO - PERO

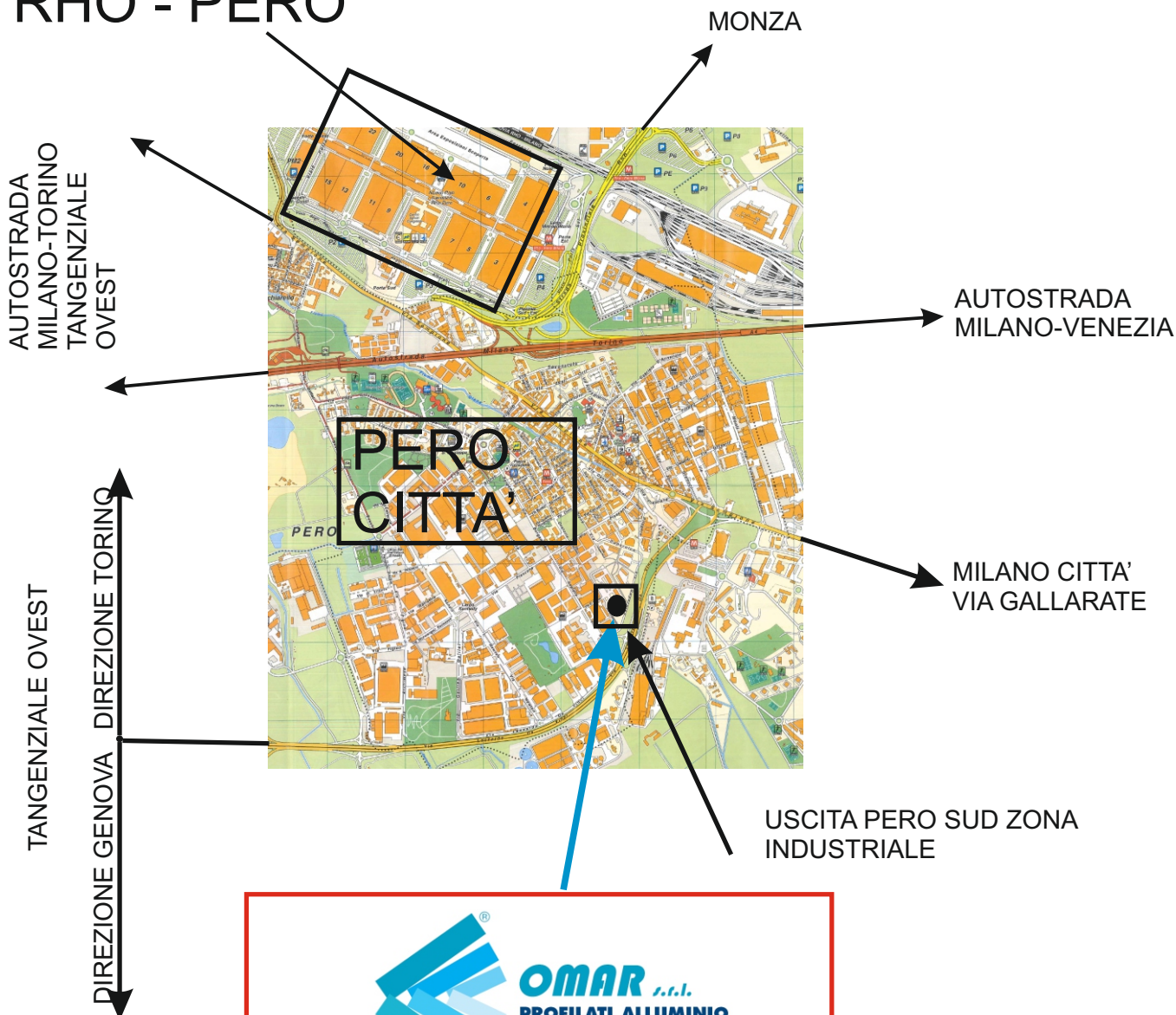

OMAR s.r.l.
PROFILATI ALLUMINIO
ALTA TECNOLOGIA

Via Newton, n.12
20016 Pero (Milano - Italy)
Tel.+39 02 3535955 r.a.
Fax.+39 02 3539929
E.Mail: info@omar-alluminio.it

Consultate il ns. catalogo aggiornato online all'indirizzo:

www.omar-alluminio.it

www.omar-alluminio.com

www.omar-alluminio.eu

PROFILATI IN ALLUMINIO
A DISEGNO-STANDARD-SPECIALI



E PER: ELETTRONICA-LED-FOTOVOLTAICO
AUTOMAZIONE ROBOTICA-PNEUMATICA-AUTOMOTIVE