

°Heat sinks for LED lighting

°Aluminium channels for LED strips  
aluminium led strip profile

°Heatsinks for LED lighting

°LED Cooling Solutions

°Extruded Heat Sink

°Heat sink design

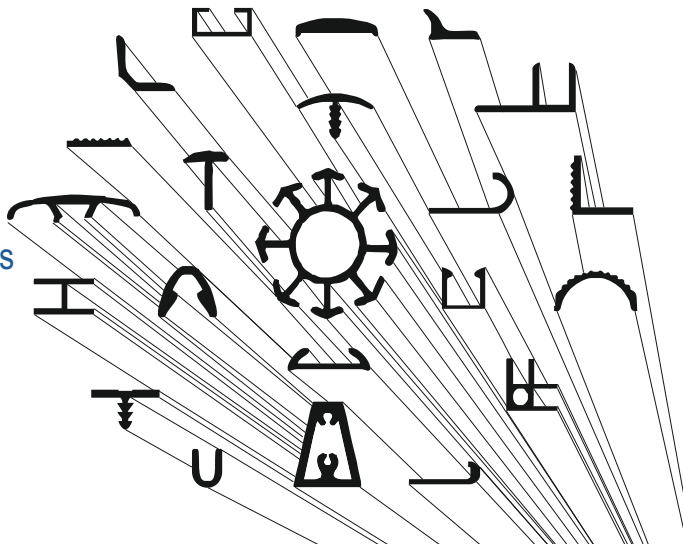

**OMAR s.r.l.**  
**PROFILATI ALLUMINIO**  
**ALTA TECNOLOGIA**

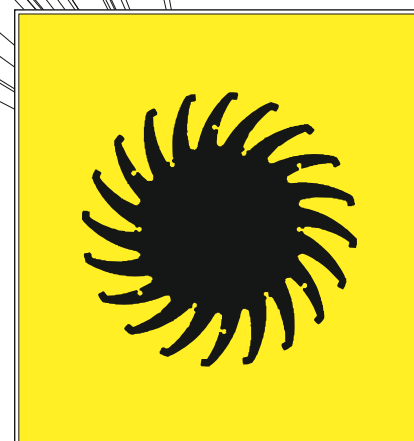

*Le "molte forme" della billetta d'alluminio*  
Aluminium LED heat sink E.catalogue  
Edizione Maggio 2015

Consultate il catalogo aggiornato  
online su:

[www.omar-alluminio.it](http://www.omar-alluminio.it)  
[www.omar-alluminio.com](http://www.omar-alluminio.com)  
[www.led.sm](http://www.led.sm)

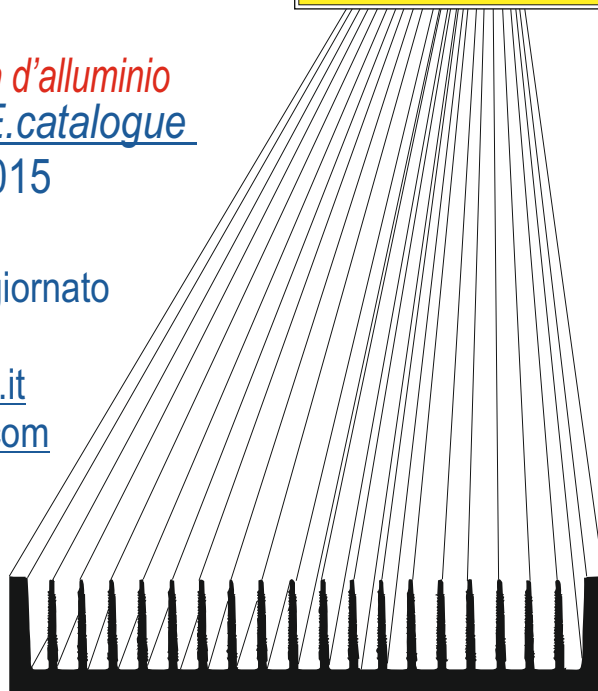

**Via Newton, n.12**  
**20016 Pero (Milano - Italy)**  
**Tel.+39 02 3535955 r.a.**  
**Fax.+39 02 3539929**  
**E.Mail: info@omar-alluminio.it**

PROFILATI IN ALLUMINIO  
A DISEGNO-STANDARD-SPECIALI



ED: ELETTRONICA-LED-FOTOVOLTAICO  
AUTOMAZIONE-ROBOTICA-PNEUMATICA-AUTOMOTIVE

# Dissipatori di calore in alluminio per illuminazione a Led

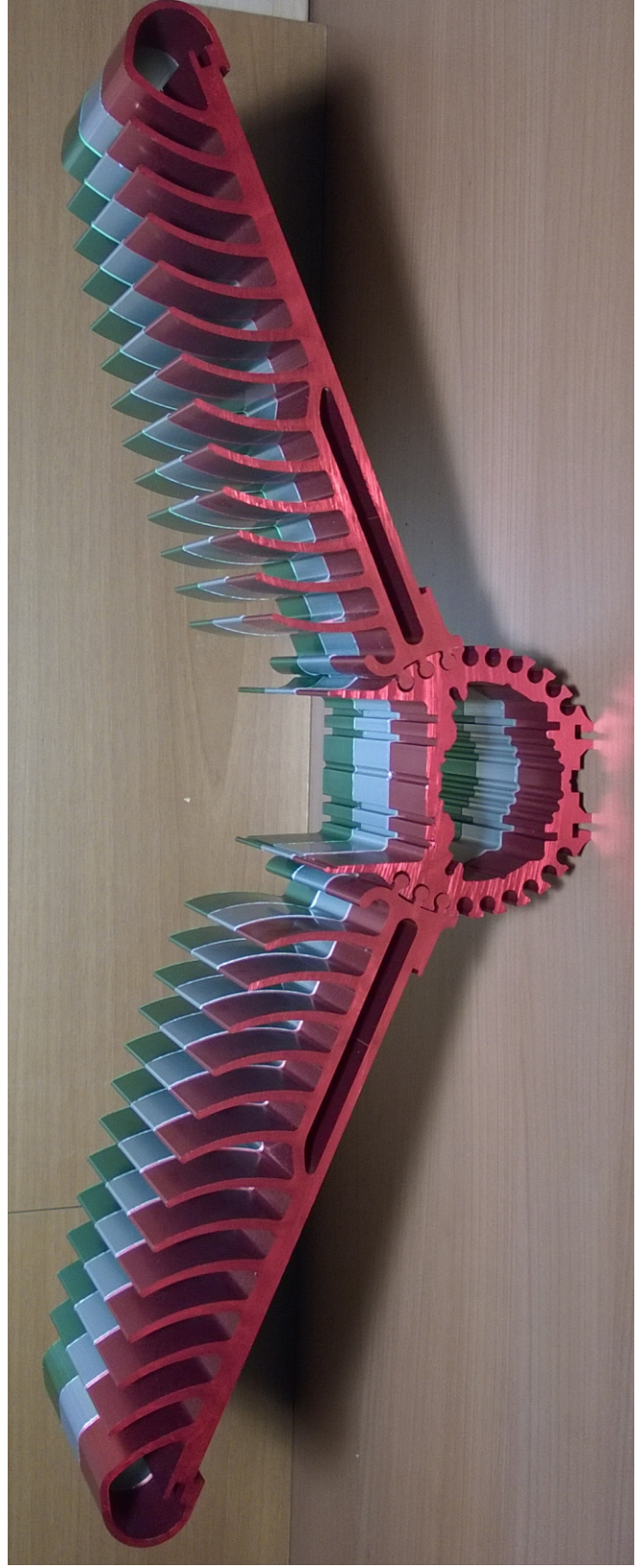
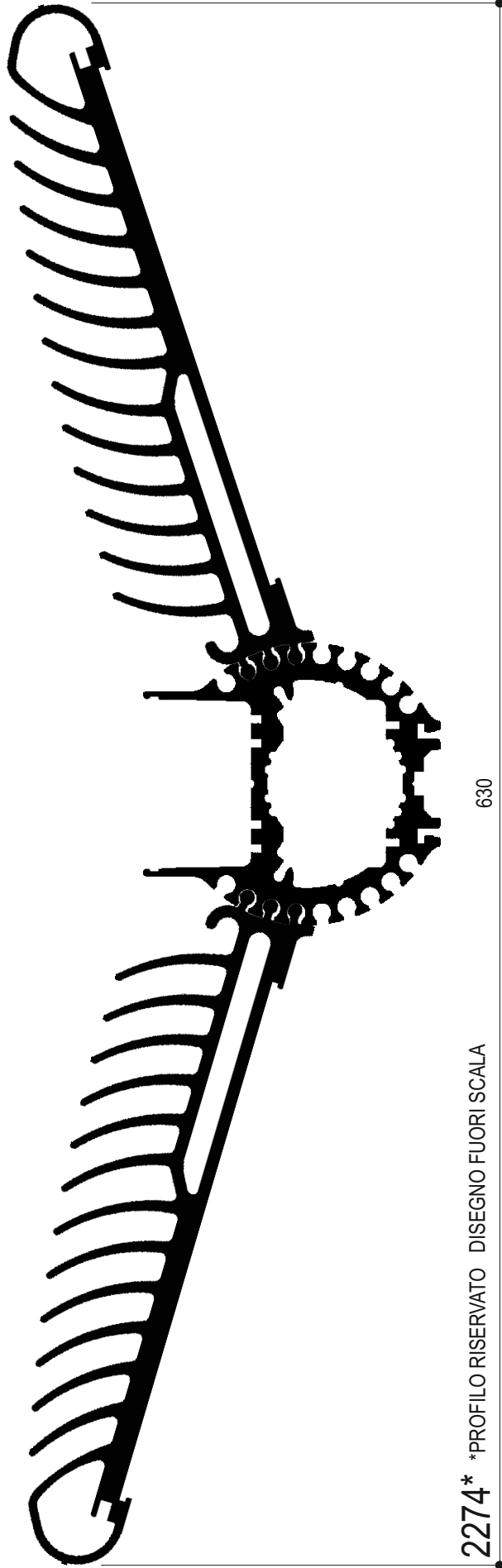

# Dissipatori di calore in alluminio per illuminazione a Led

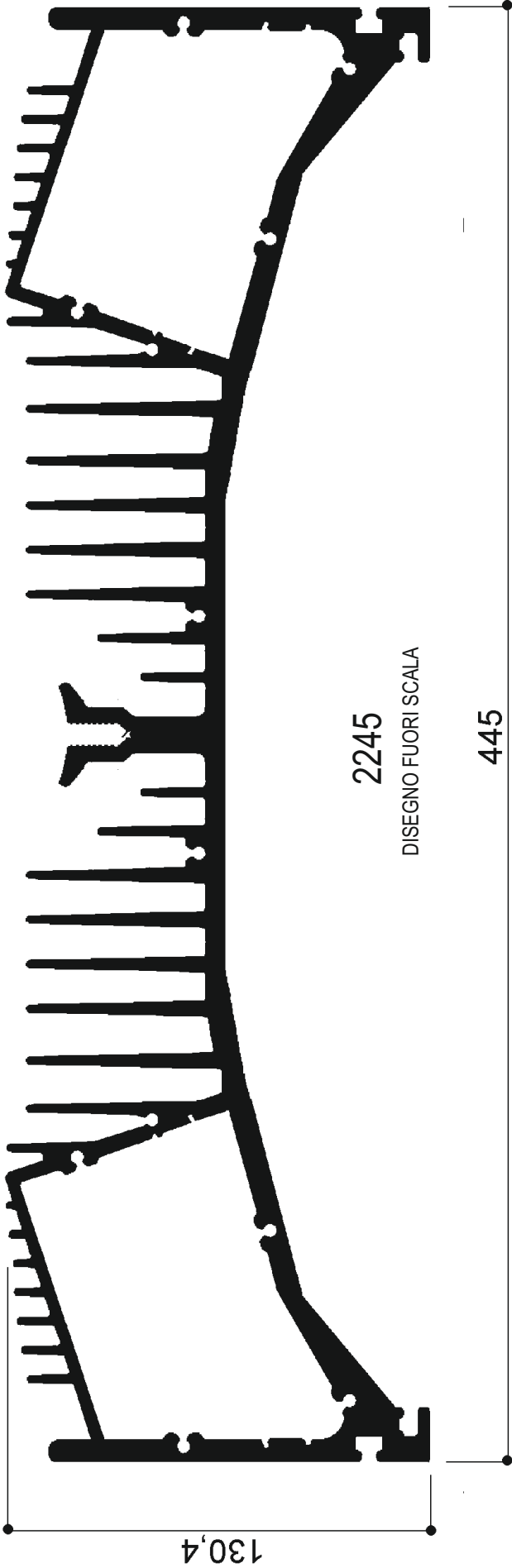

2245

DISEGNO FUORI SCALA

445

130,4

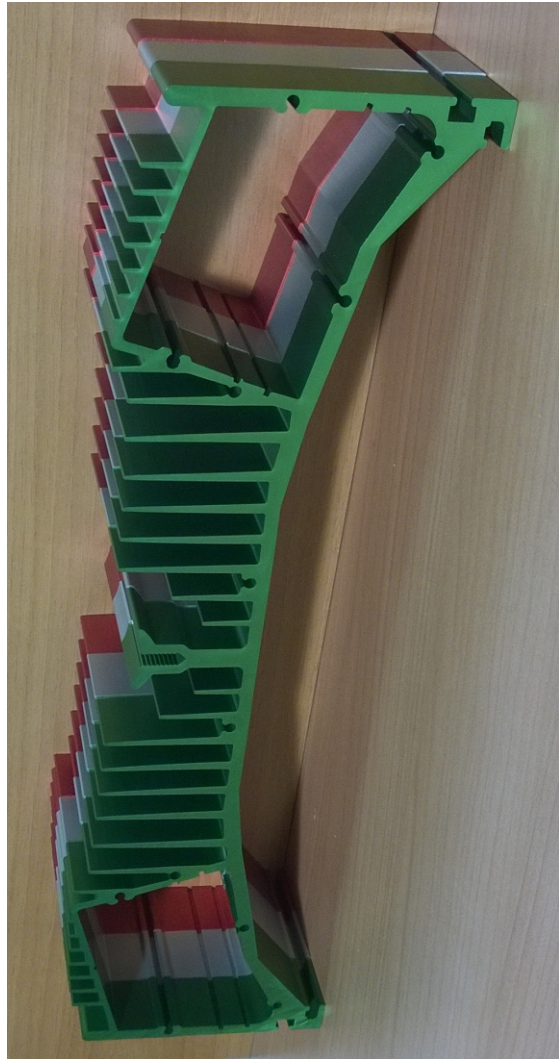

Cataloghi Online: [www.omar-alluminio.it](http://www.omar-alluminio.it)

[www.omar-alluminio.com](http://www.omar-alluminio.com)

PROFILATI ALLUMINIO A DISEGNO / STANDARD / SPECIALI / E PER:

ELETTRONICA / LED / FOTOVOLTAICO / AUTOMAZIONE ROBOTICA / PNEUMATICA / AUTOMOTIVE

Via Newton, n.12

20016 Pero (Milano - Italy)

Tel. +39 02 3535955 r.a. Fax. +39 02 3539929

E-Mail: [info@omar-alluminio.it](mailto:info@omar-alluminio.it)



# Dissipatori di calore in alluminio per illuminazione a Led

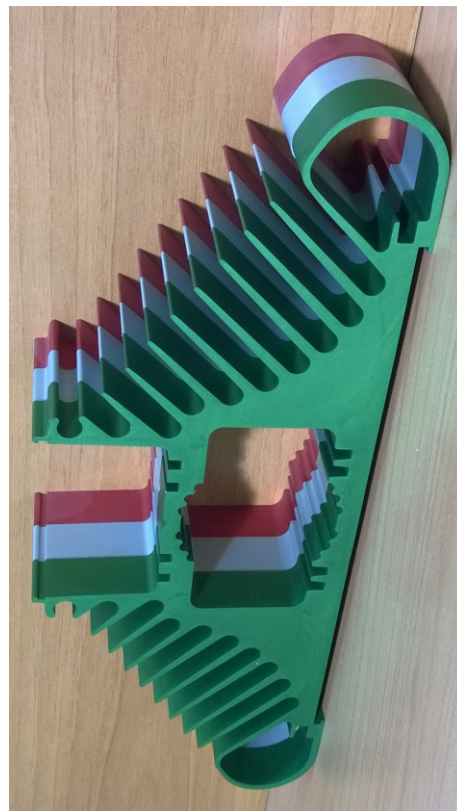
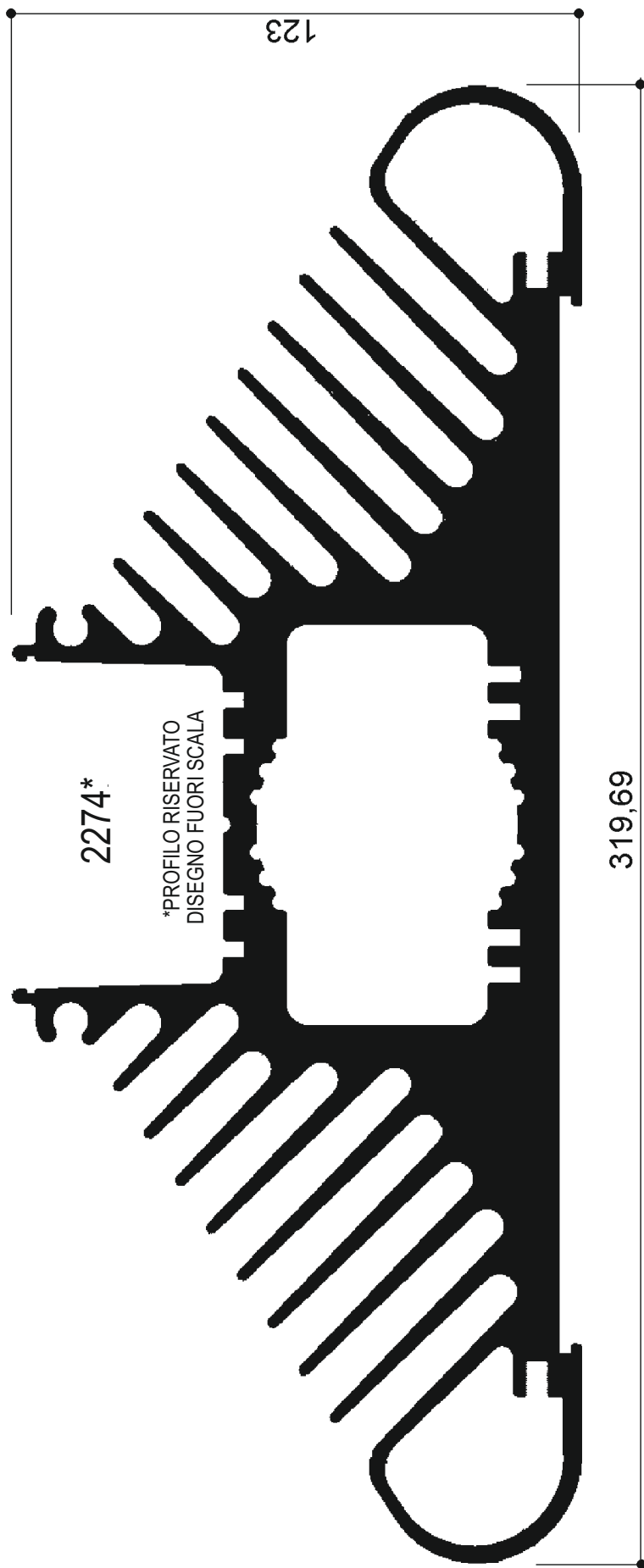

# Dissipatori di calore in alluminio per illuminazione a Led



**\*PROFILO RISERVATO**  
DISEGNO FUORI SCALA

2271\*

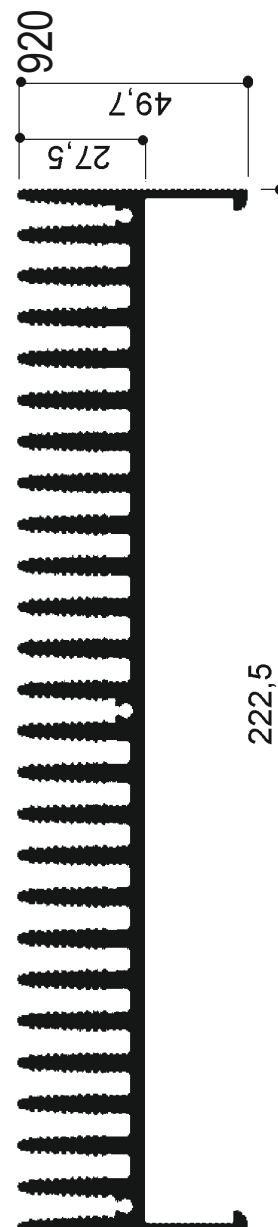
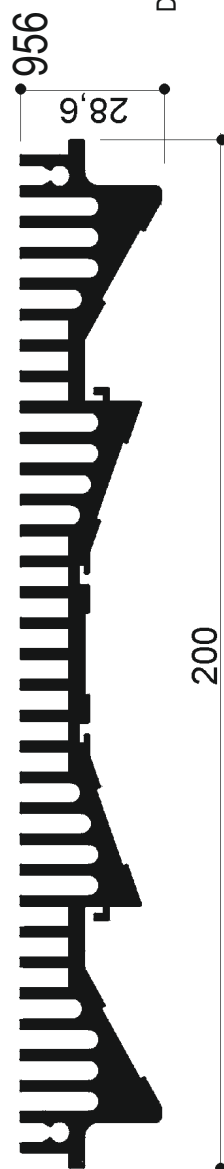
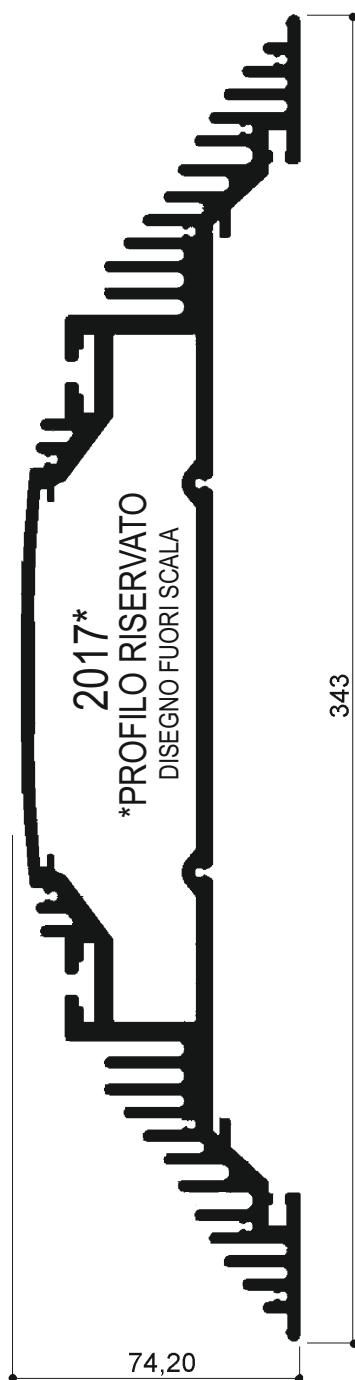
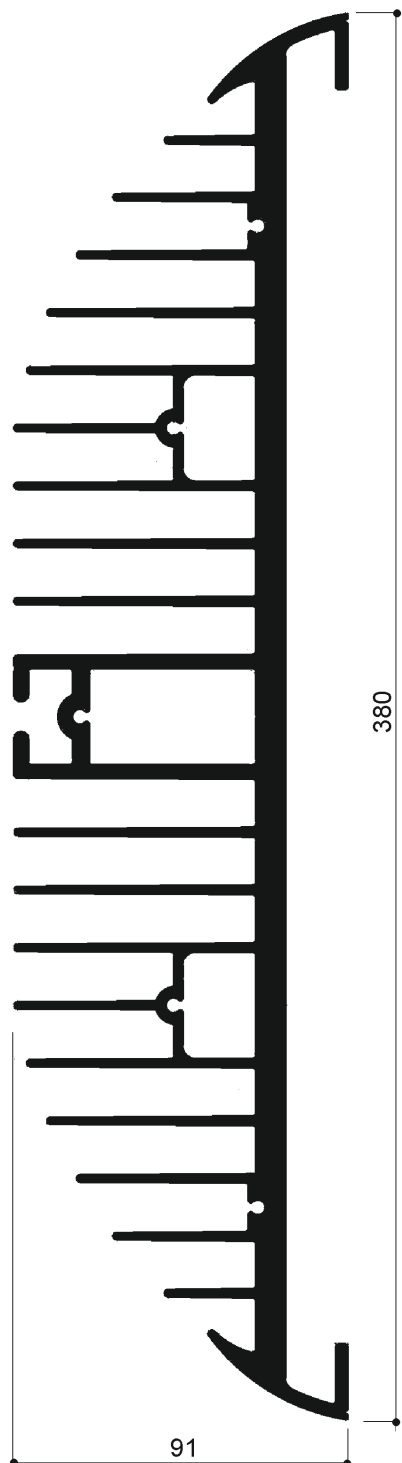

-RIPRODUZIONE VIETATA-  
AGGIORNAMENTO CONTINUO - ED. DEL 05/-



Cataloghi Online: [www.omar-alluminio.it](http://www.omar-alluminio.it)

[www.omar-alluminio.com](http://www.omar-alluminio.com)

PROFILATI ALLUMINIO A DISEGNO / STANDARD / SPECIALI / E PER:

ELETTRONICA / LED / FOTOVOLTAICO / AUTOMAZIONE ROBOTICA / PNEUMATICA / AUTOMOTIVE

Via Newton, n.12

20016 Pero (Milano - Italy)

Tel. +39 02 3535955 r.a. Fax. +39 02 3539929

E-Mail: [info@omar-alluminio.it](mailto:info@omar-alluminio.it)

# Dissipatori di calore in alluminio per illuminazione a Led



DISEGNI AL VERO (1:1)- SCALE 1:1

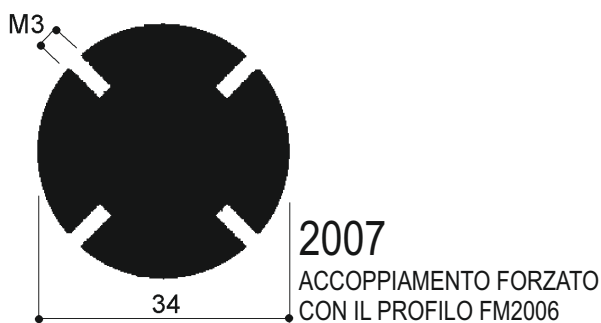
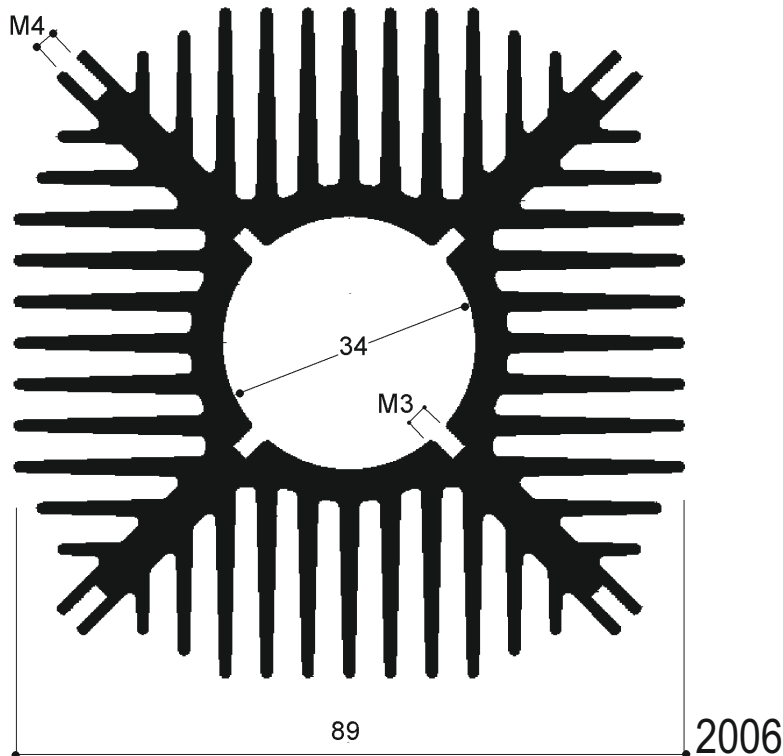
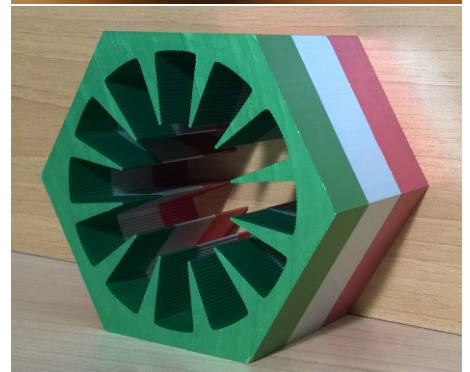
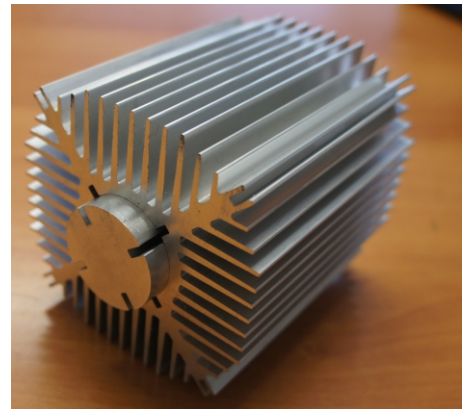
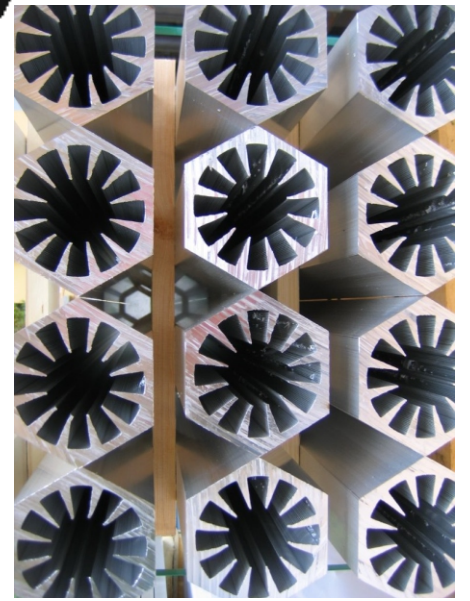
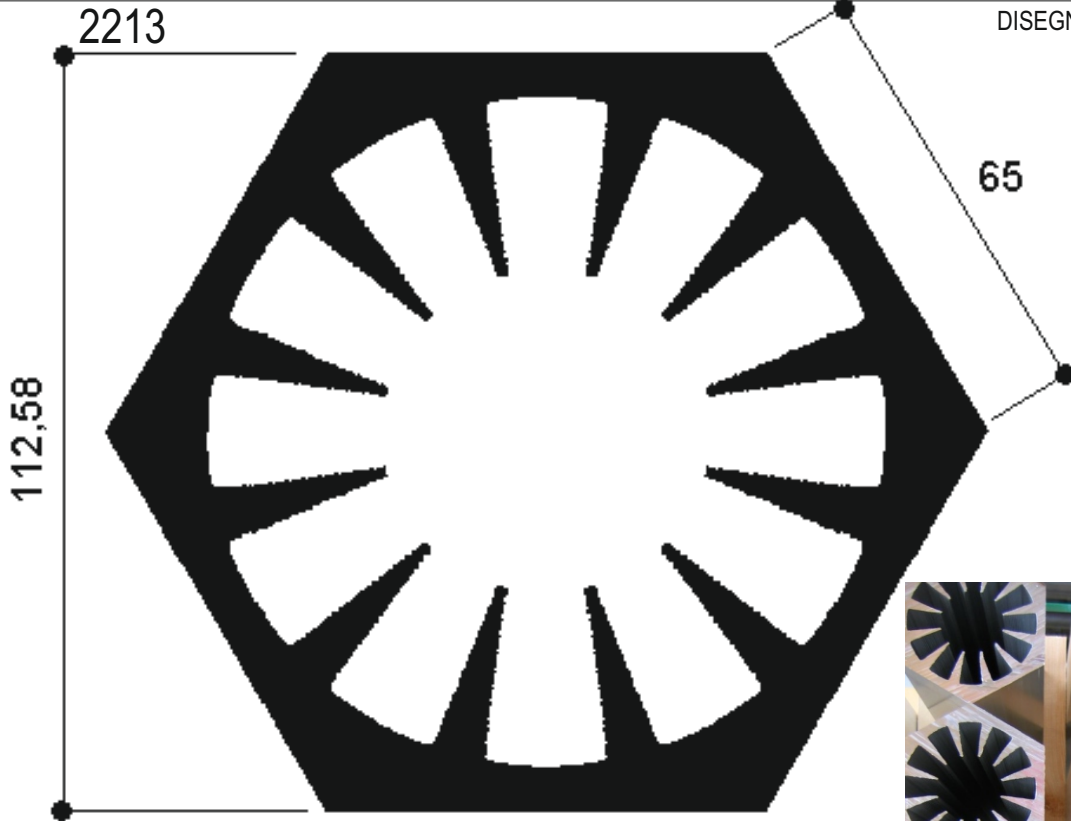

Via Newton, n.12

20016 Pero (Milano - Italy)

Tel. +39 02 3535955 r.a. Fax. +39 02 3539929

E-Mail: info@omar-alluminio.it

Cataloghi Online: [www.omar-alluminio.it](http://www.omar-alluminio.it)

[www.omar-alluminio.com](http://www.omar-alluminio.com)

PROFILATI ALLUMINIO A DISEGNO / STANDARD / SPECIALI / E PER:

ELETRONICA / LED / FOTOVOLTAICO / AUTOMAZIONE ROBOTICA / PNEUMATICA / AUTOMOTIVE



-RIPRODUZIONE VIETATA-

AGGIORNAMENTO CONTINUO - ED. DEL 05-2015

Pag.5/L

# Dissipatori di calore in alluminio per illuminazione a Led



DISEGNO FUORI SCALA

\*PROFILO RISERVATO

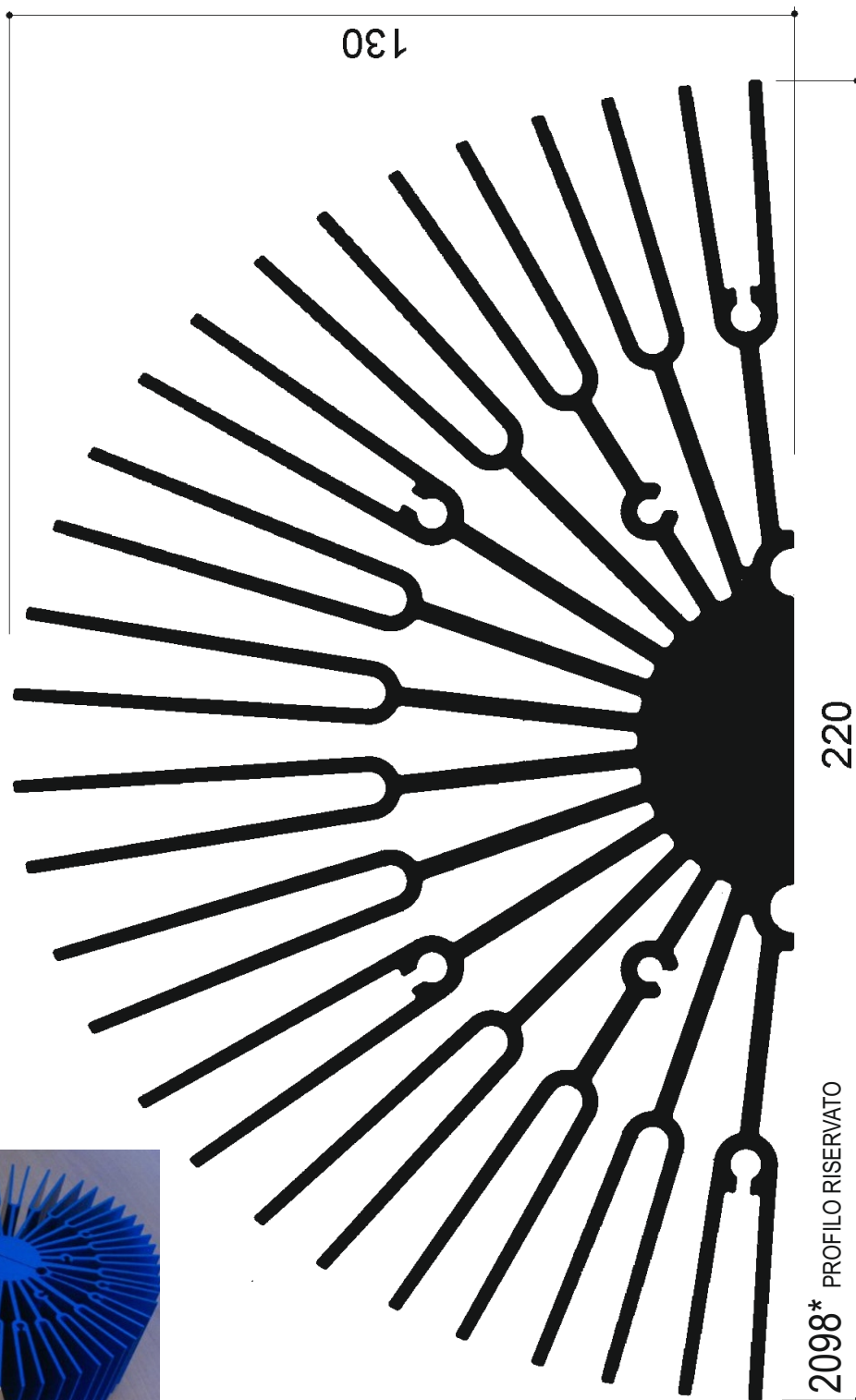
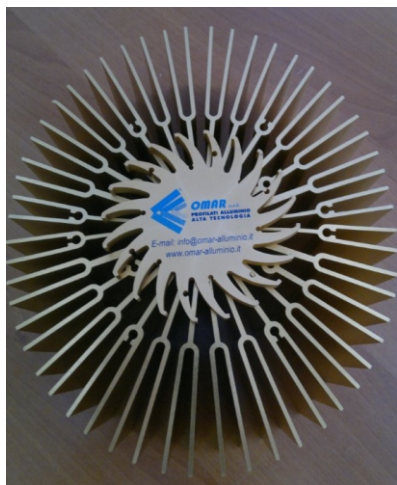

Cataloghi Online: [www.omar-alluminio.it](http://www.omar-alluminio.it)

[www.omar-alluminio.com](http://www.omar-alluminio.com)

PROFILATI ALLUMINIO A DISEGNO / STANDARD / SPECIALI / E PER:

ELETTRONICA / LED / FOTVOLTAICO / AUTOMAZIONE ROBOTICA / PNEUMATICA / AUTOMOTIVE

Via Newton, n.12

20016 Pero (Milano - Italy)

Tel. +39 02 3535955 r.a. Fax. +39 02 3539929

E-Mail: [info@omar-alluminio.it](mailto:info@omar-alluminio.it)



# Dissipatori di calore tondi in alluminio per illuminazione a Led



Via Newton, n.12

20016 Pero (Milano - Italy)

Tel. +39 02 3535955 r.a. Fax. +39 02 3539929

E-Mail: info@omar-alluminio.it

Cataloghi Online: [www.omar-alluminio.it](http://www.omar-alluminio.it)

[www.omar-alluminio.com](http://www.omar-alluminio.com)

PROFILATI ALLUMINIO A DISEGNO / STANDARD / SPECIALI / E PER:  
ELETTRONICA / LED / FOTOVOLTAICO / AUTOMAZIONE ROBOTICA / PNEUMATICA / AUTOMOTIVE

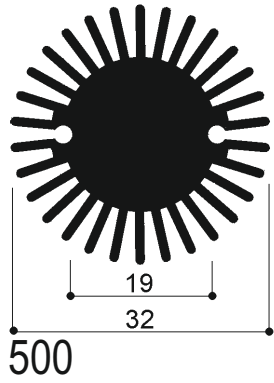
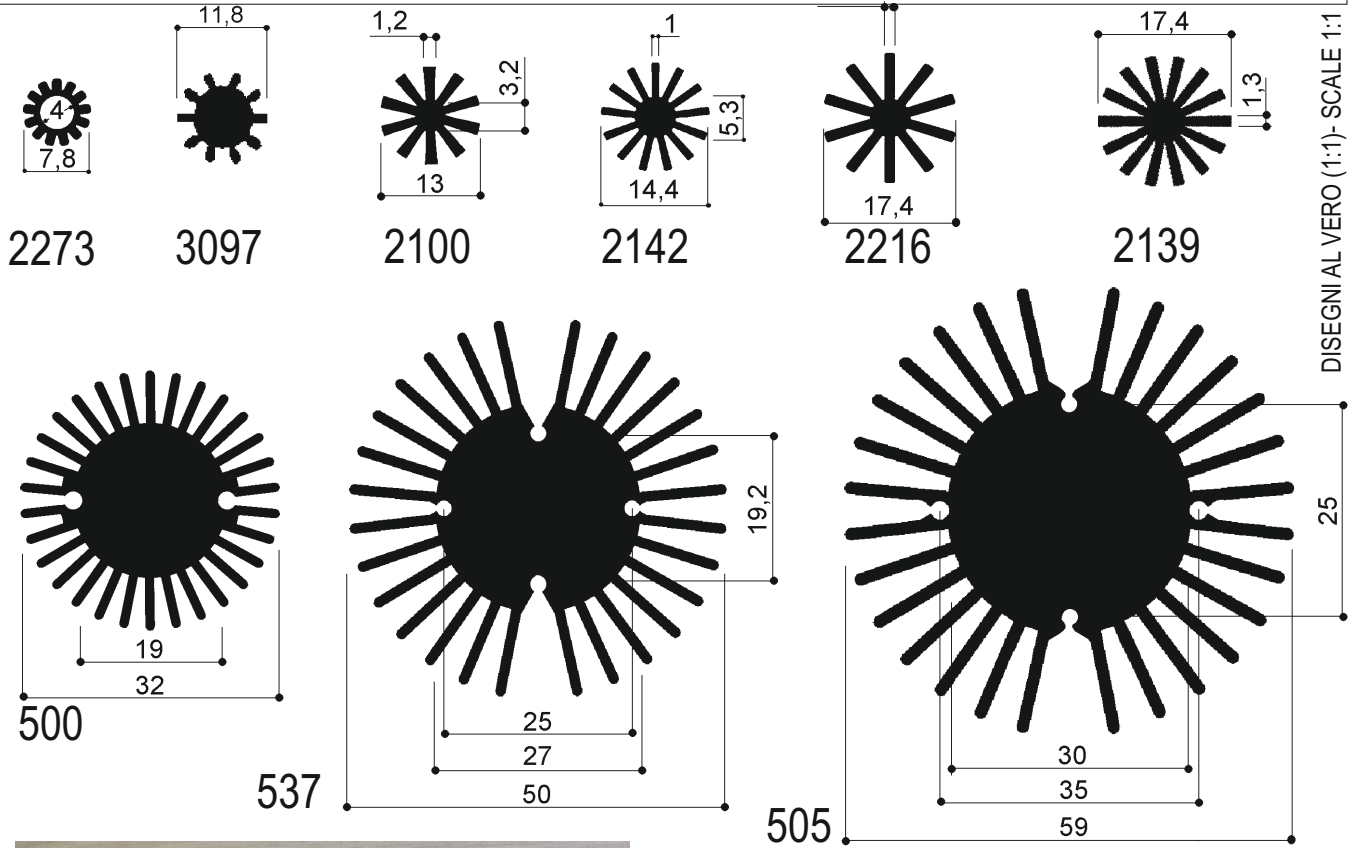

537

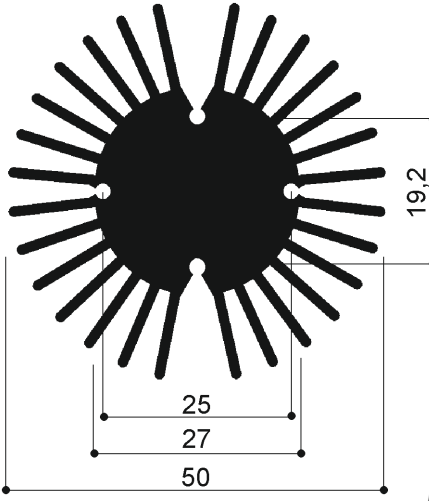

505

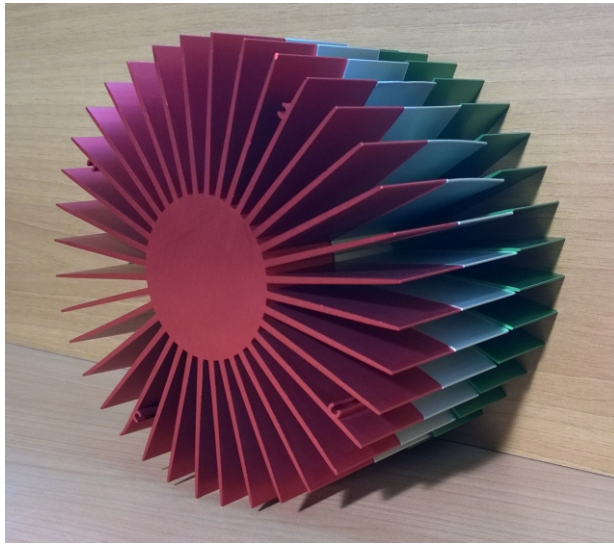
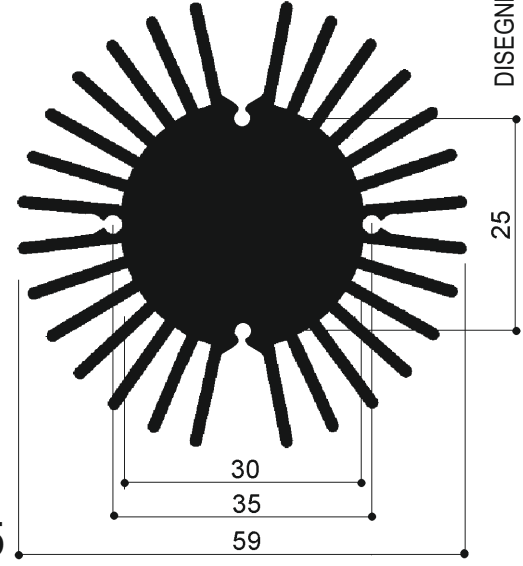

AGGIORNAMENTO CONTINUO - ED. DEL 5-2015  
-RIPRODUZIONE VIETATA-

2074D46

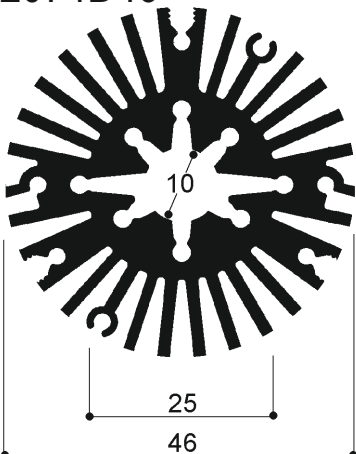

2074

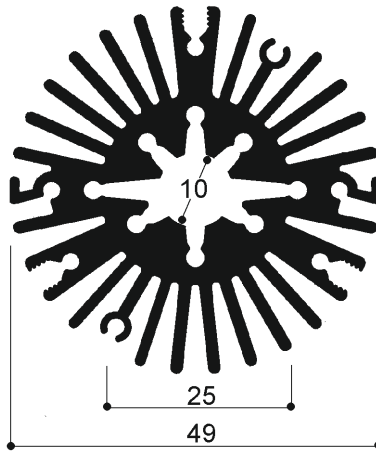

509

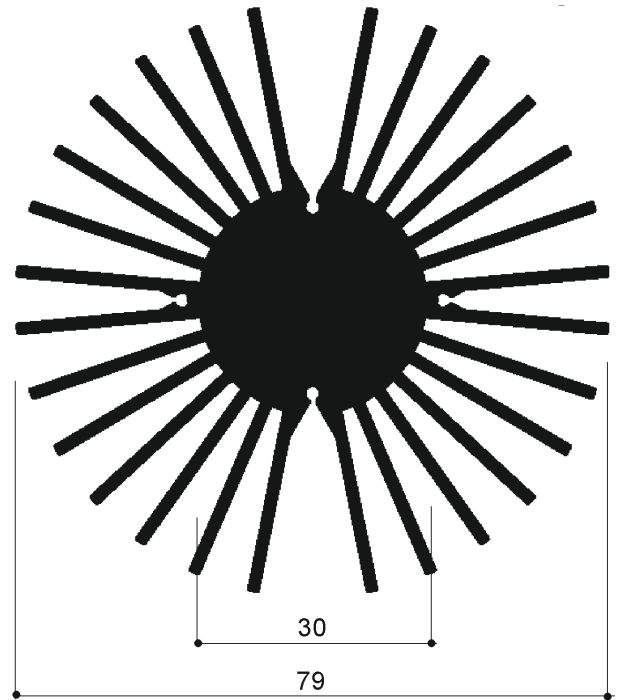

2074C

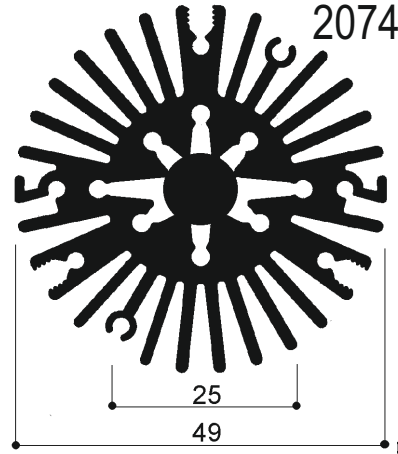



# Dissipatori di calore tondi in alluminio per illuminazione a Led



DISEGNI AL VERO (1:1)- SCALE 1:1

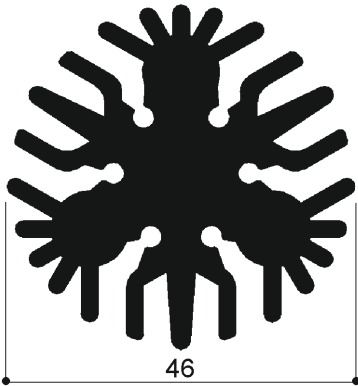
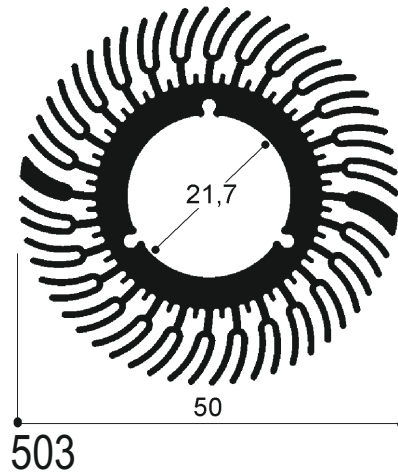
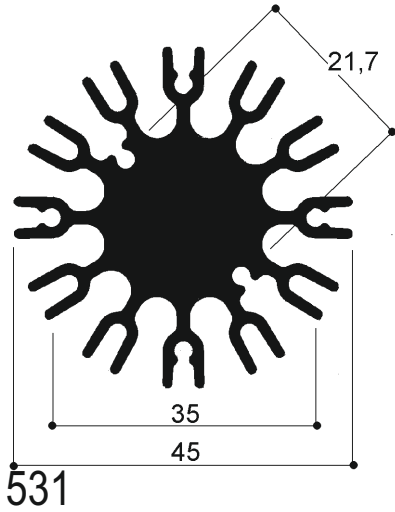

2075

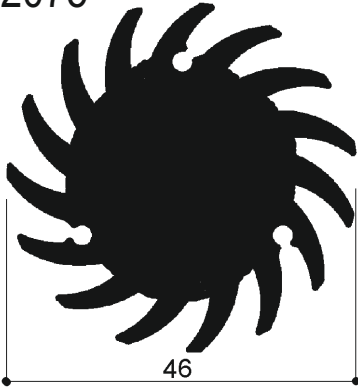

2072D46

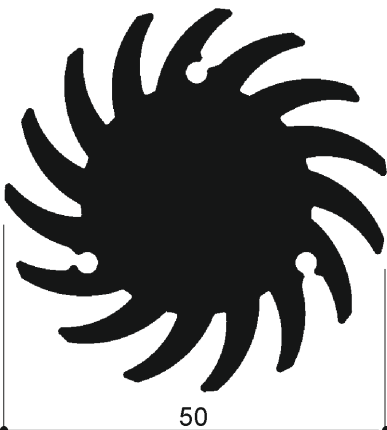

2072

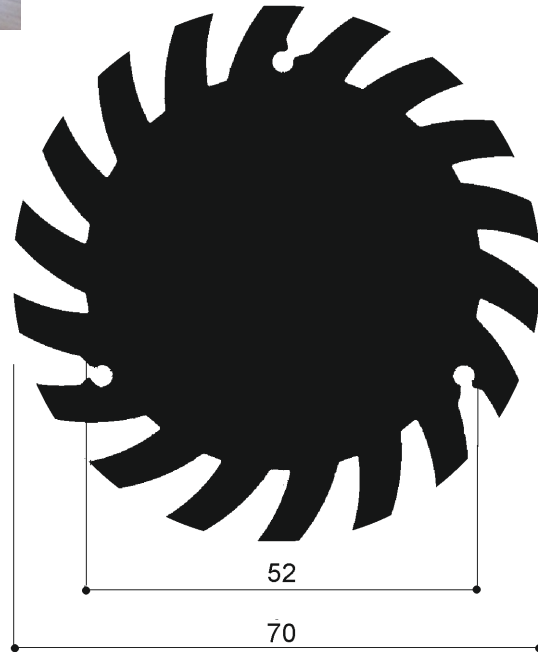

2073D70

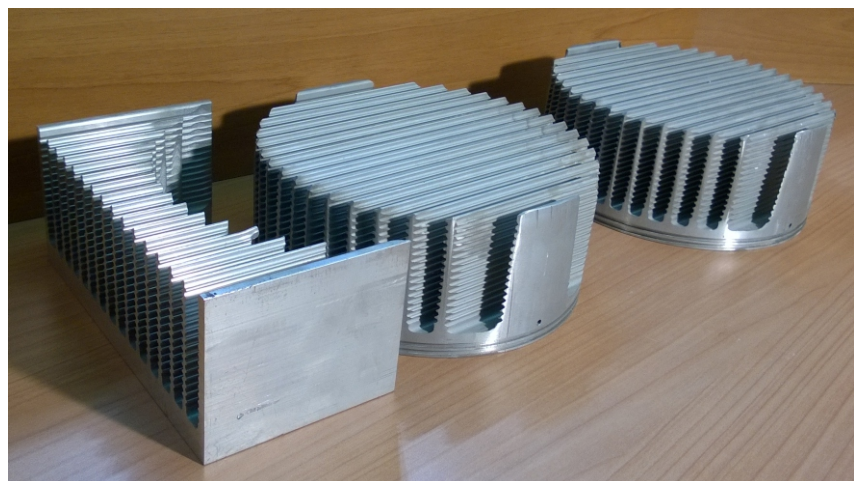

Via Newton, n.12  
20016 Pero (Milano - Italy)  
Tel. +39 02 3535955 r.a. Fax. +39 02 3539929  
E.Mail: info@omar-alluminio.it

Cataloghi Online: [www.omar-alluminio.it](http://www.omar-alluminio.it)  
[www.omar-alluminio.com](http://www.omar-alluminio.com)

PROFILATI ALLUMINIO A DISEGNO / STANDARD / SPECIALI / E PER:  
ELETTRONICA / LED / FOTOVOLTAICO / AUTOMAZIONE ROBOTICA / PNEUMATICA / AUTOMOTIVE



# Dissipatori di calore tondi in alluminio per illuminazione a Led



DISEGNI AL VERO (1:1)- SCALE 1:1

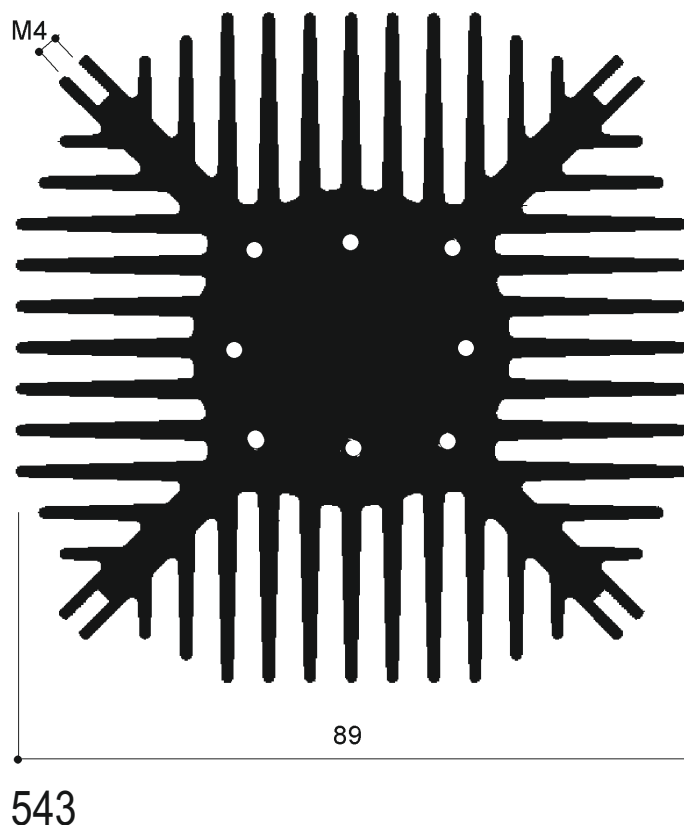
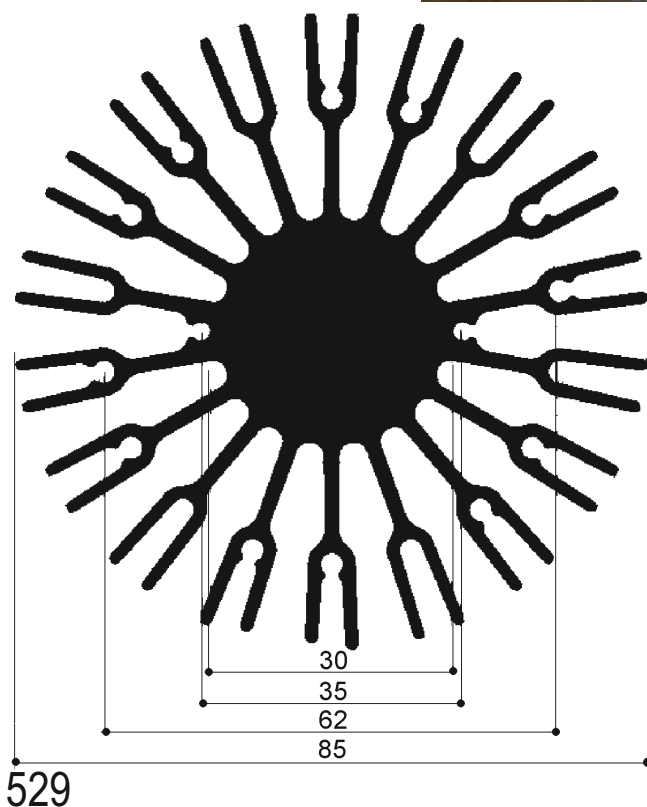
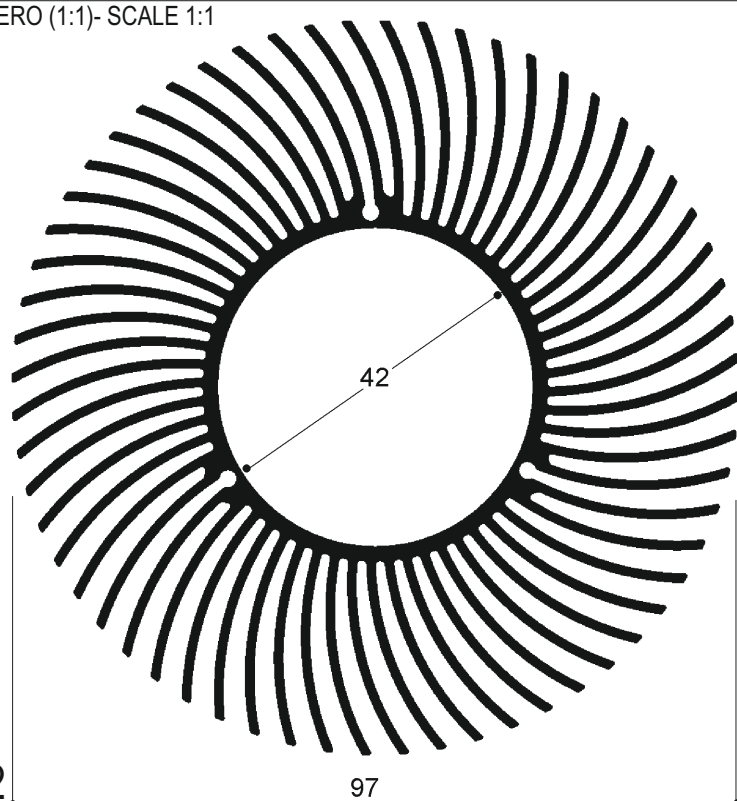
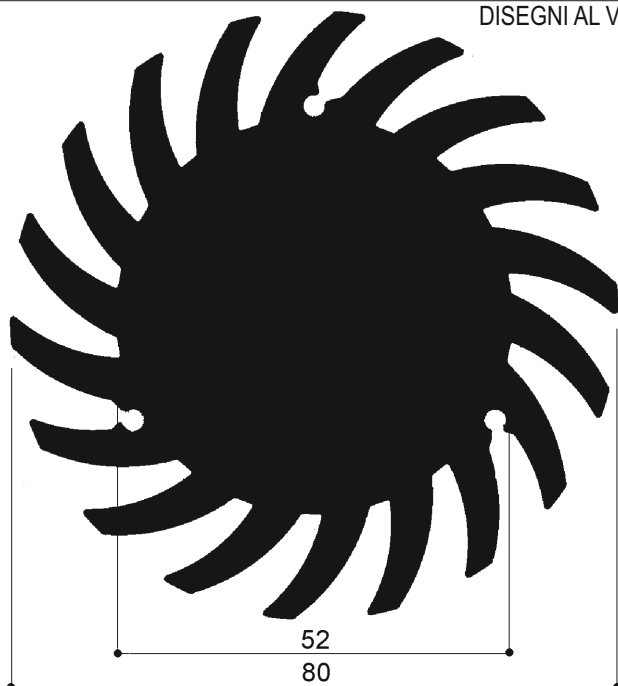

Via Newton, n.12

20016 Pero (Milano - Italy)

Tel. +39 02 3535955 r.a. Fax. +39 02 3539929

E-Mail: info@omar-alluminio.it

Cataloghi Online: [www.omar-alluminio.it](http://www.omar-alluminio.it)

[www.omar-alluminio.com](http://www.omar-alluminio.com)

PROFILATI ALLUMINIO A DISEGNO / STANDARD / SPECIALI / E PER:

ELETTRONICA / LED / FOTOVOLTAICO / AUTOMAZIONE ROBOTICA / PNEUMATICA / AUTOMOTIVE

**OMAR** s.r.l.  
PROFILATI ALLUMINIO  
ALTA TECNOLOGIA



# Dissipatori di calore tondi in alluminio per illuminazione a Led



DISEGNI AL VERO (1:1)- SCALE 1:1

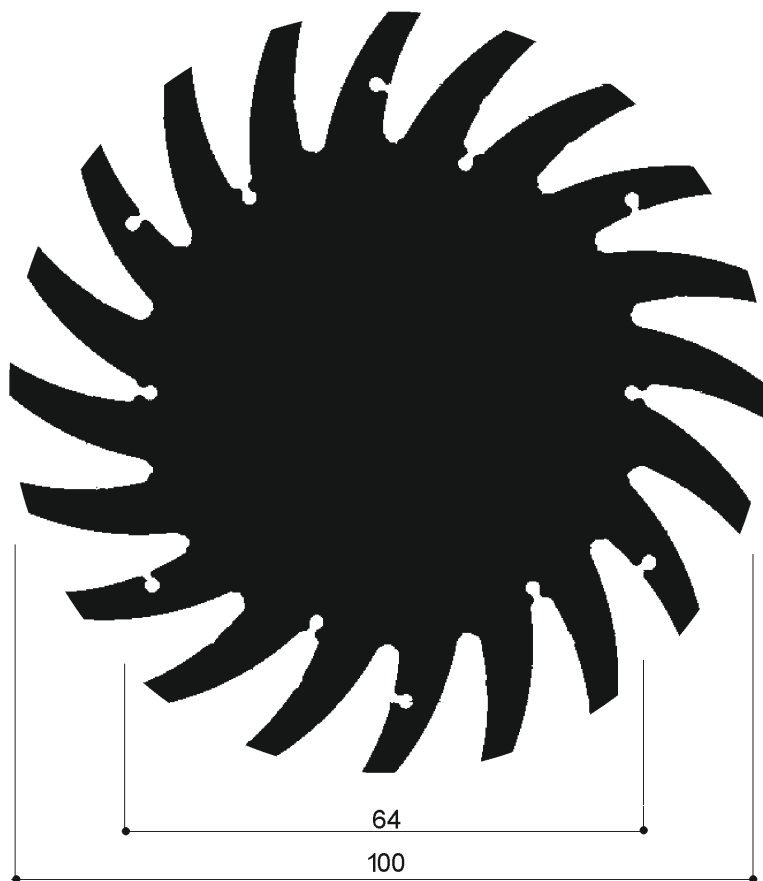

2076D100

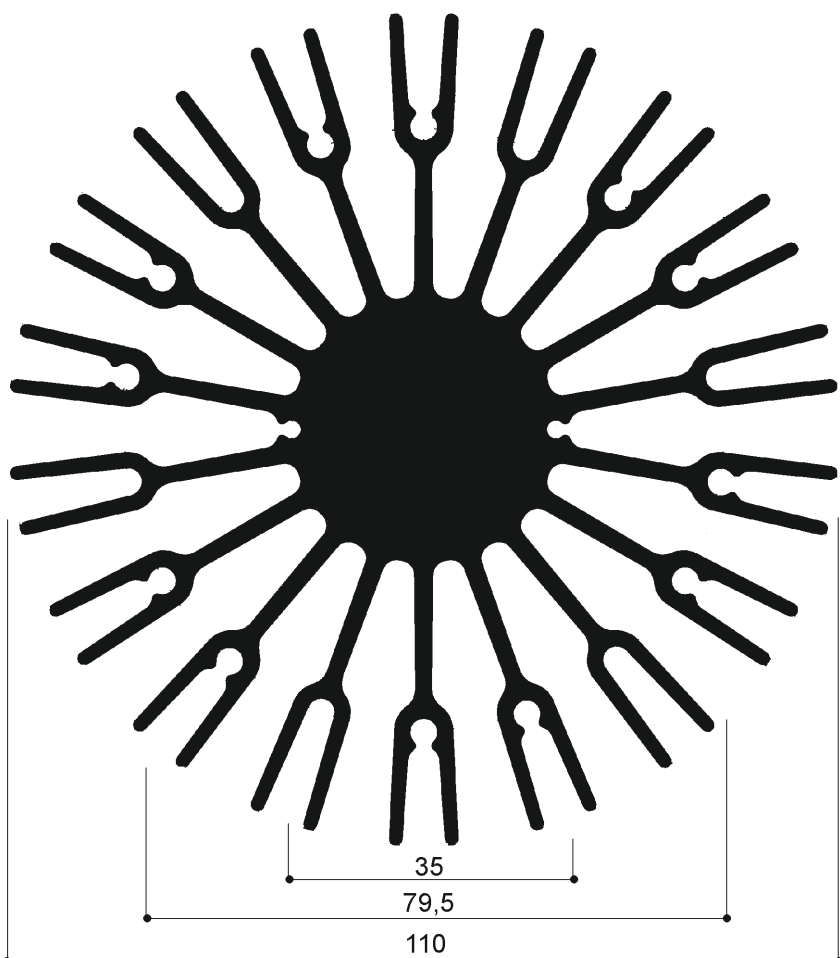

532

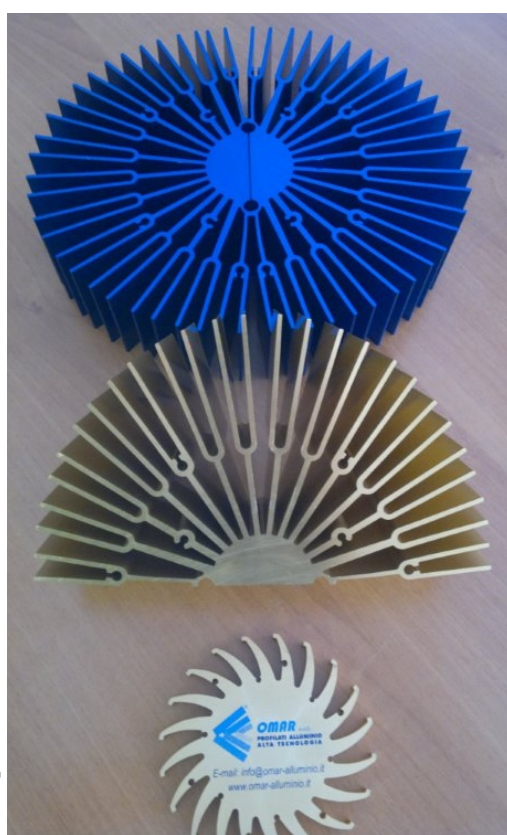

Cataloghi Online: [www.omar-alluminio.it](http://www.omar-alluminio.it)

[www.omar-alluminio.com](http://www.omar-alluminio.com)

PROFILATI ALLUMINIO A DISEGNO / STANDARD / SPECIALI / E PER:

ELETTRONICA / LED / FOTOVOLTAICO / AUTOMAZIONE ROBOTICA / PNEUMATICA / AUTOMOTIVE



Via Newton, n.12

20016 Pero (Milano - Italy)

Tel. +39 02 3535955 r.a. Fax. +39 02 3539929

E-Mail: [info@omar-alluminio.it](mailto:info@omar-alluminio.it)

# Dissipatori di calore tondi in alluminio per illuminazione a Led



Via Newton, n.12  
20016 Pero (Milano - Italy)  
Tel. +39 02 3535955 r.a. Fax. +39 02 3539929  
E.Mail: info@omar-alluminio.it

Cataloghi Online: [www.omar-alluminio.it](http://www.omar-alluminio.it)  
[www.omar-alluminio.com](http://www.omar-alluminio.com)

PROFILATI ALLUMINIO A DISEGNO / STANDARD / SPECIALI / E PER:  
ELETTRONICA / LED / FOTOVOLTAICO / AUTOMAZIONE ROBOTICA / PNEUMATICA / AUTOMOTIVE

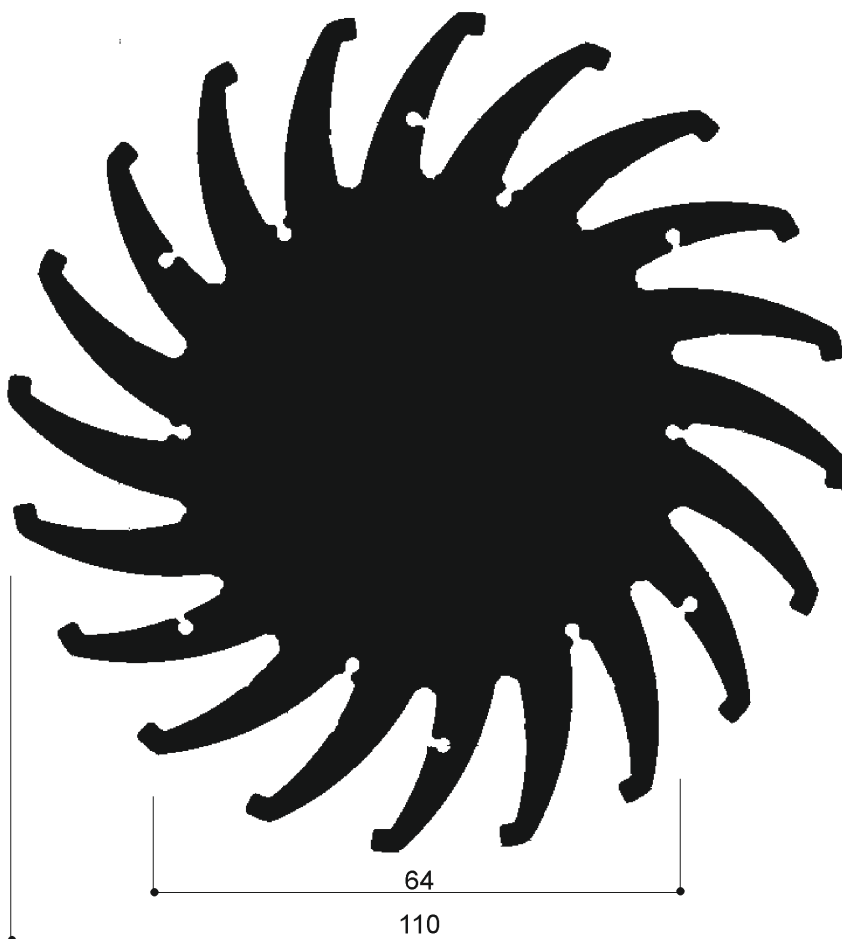
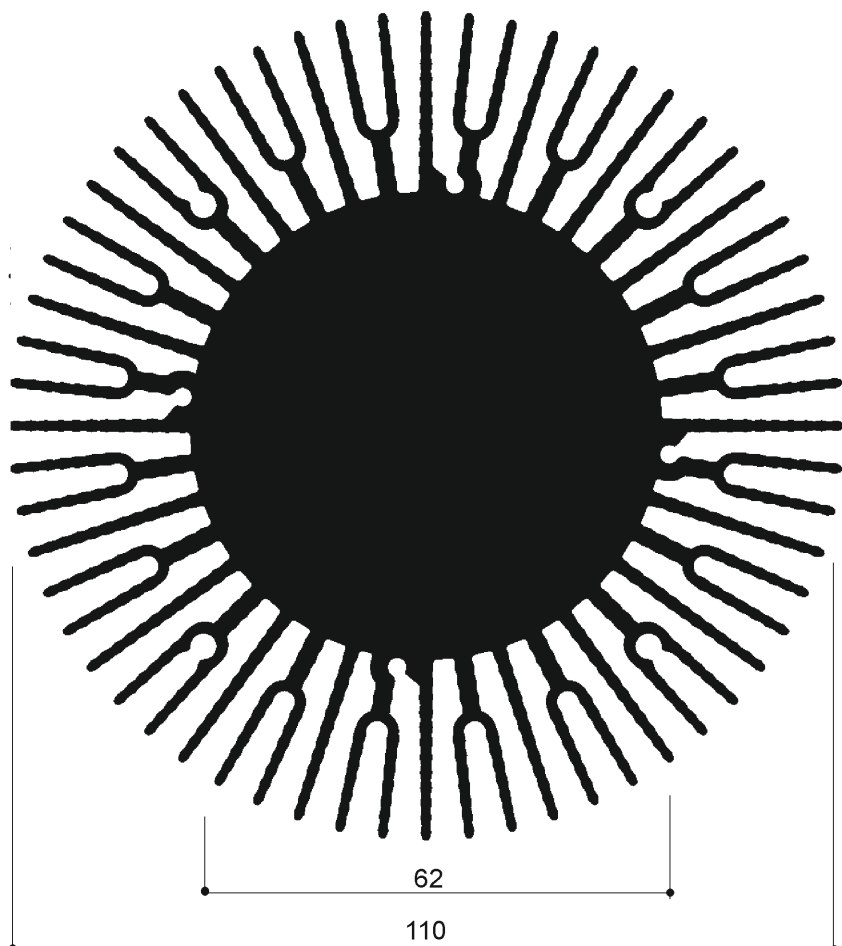

# Dissipatori di calore in alluminio per illuminazione a Led

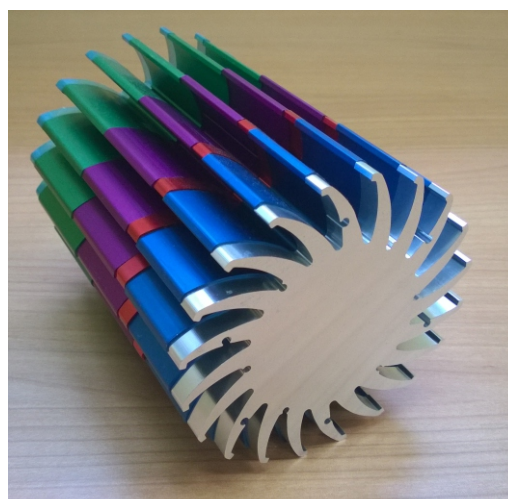
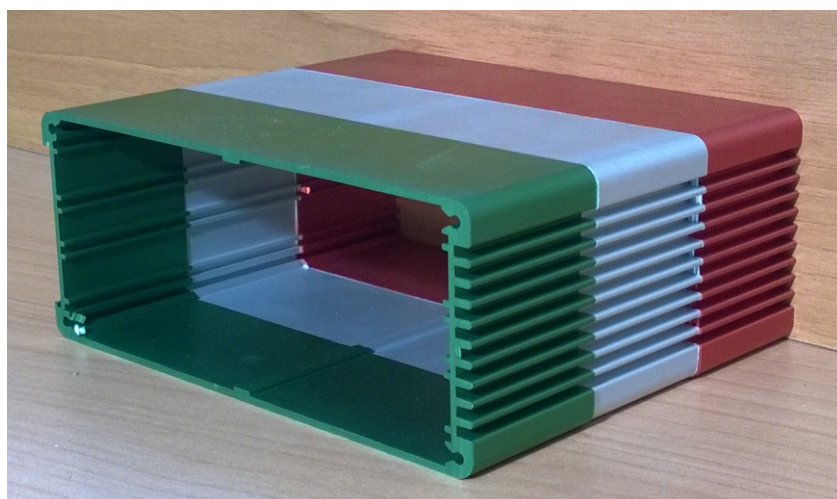
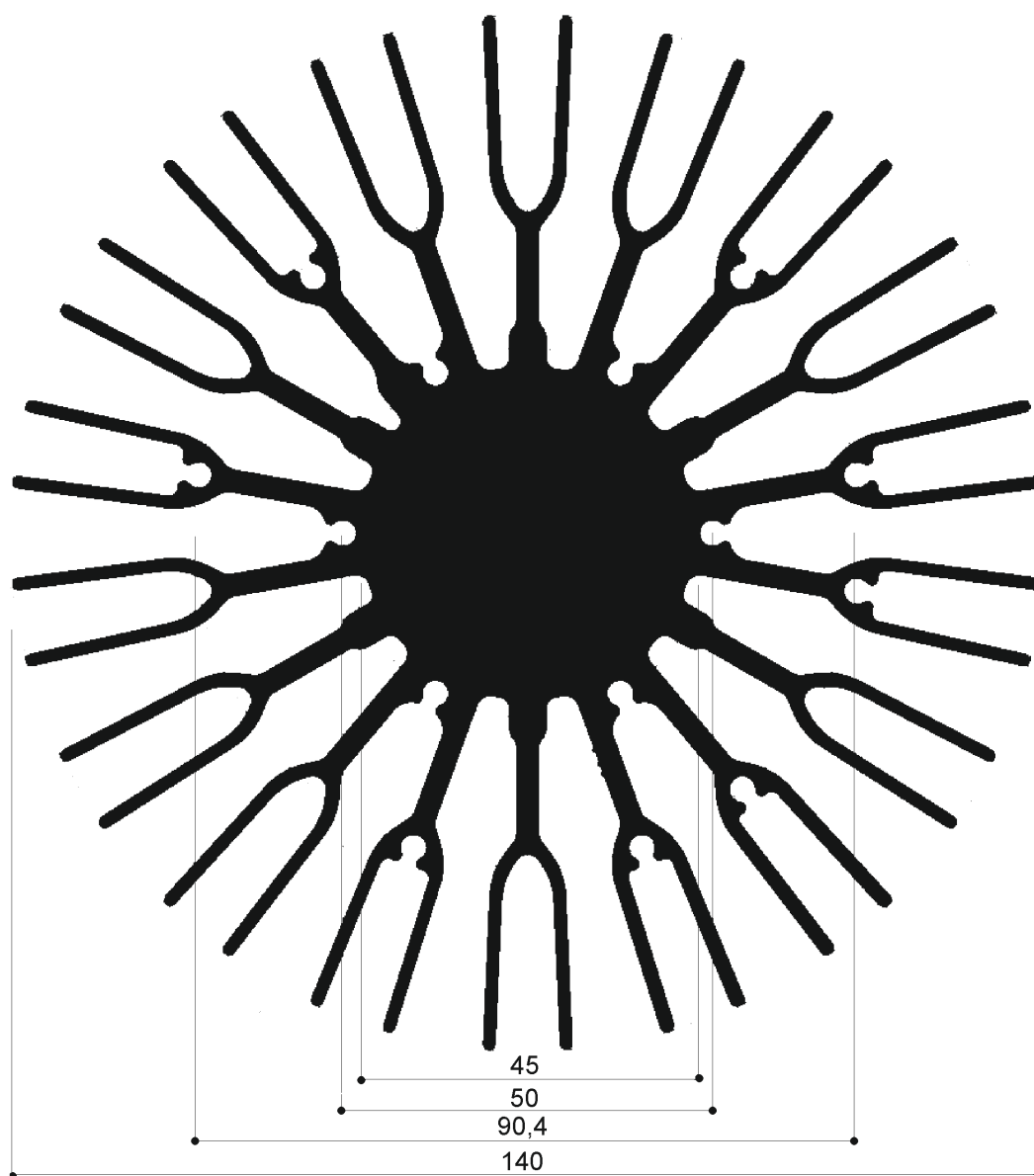

Cataloghi Online: [www.omar-alluminio.it](http://www.omar-alluminio.it)

[www.omar-alluminio.com](http://www.omar-alluminio.com)

PROFILATI ALLUMINIO A DISEGNO / STANDARD / SPECIALI / E PER:

ELETTRONICA / LED / FOTOVOLTAICO / AUTOMAZIONE ROBOTICA / PNEUMATICA / AUTOMOTIVE

Via Newton, n.12

20016 Pero (Milano - Italy)

Tel. +39 02 3535955 r.a. Fax. +39 02 3539929

E-Mail: [info@omar-alluminio.it](mailto:info@omar-alluminio.it)



# Dissipatori di calore in alluminio per illuminazione a Led



Via Newton, n.12  
20016 Pero (Milano - Italy)  
Tel. +39 02 3535955 r.a. Fax. +39 02 3539929  
E.Mail: info@omar-alluminio.it

Cataloghi Online: [www.omar-alluminio.it](http://www.omar-alluminio.it)  
[www.omar-alluminio.com](http://www.omar-alluminio.com)

PROFILATI ALLUMINIO A DISEGNO / STANDARD / SPECIALI / E PER:  
ELETTRONICA / LED / FOTOVOLTAICO / AUTOMAZIONE ROBOTICA / PNEUMATICA / AUTOMOTIVE

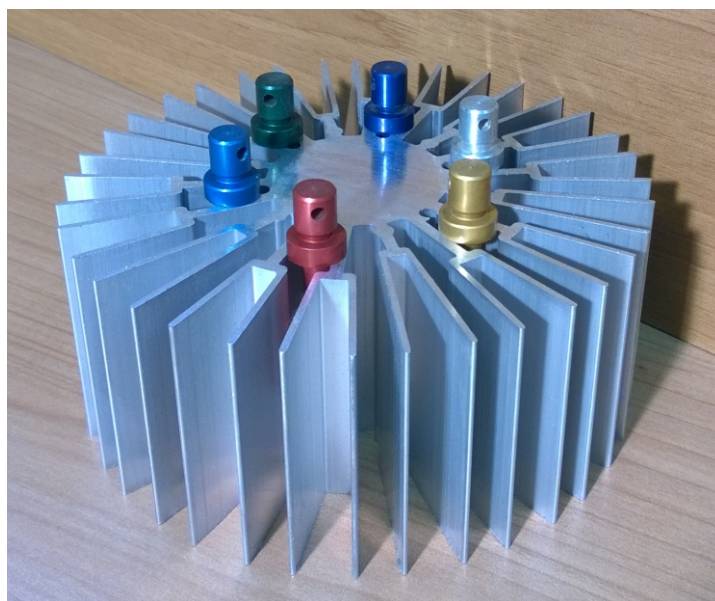
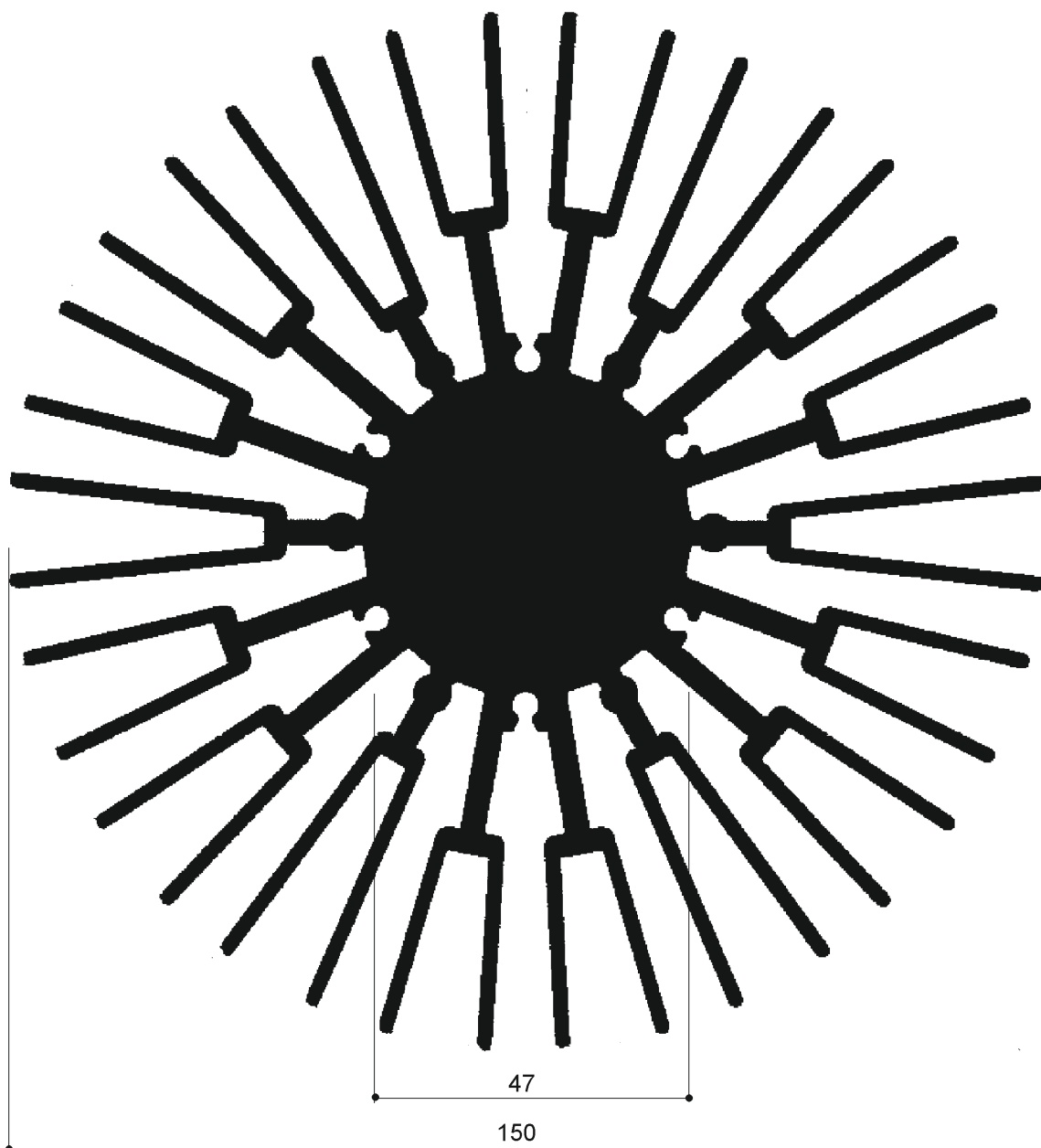

# Dissipatori di calore in alluminio per illuminazione a Led



DISEGNI AL VERO (1:1)- SCALE 1:1

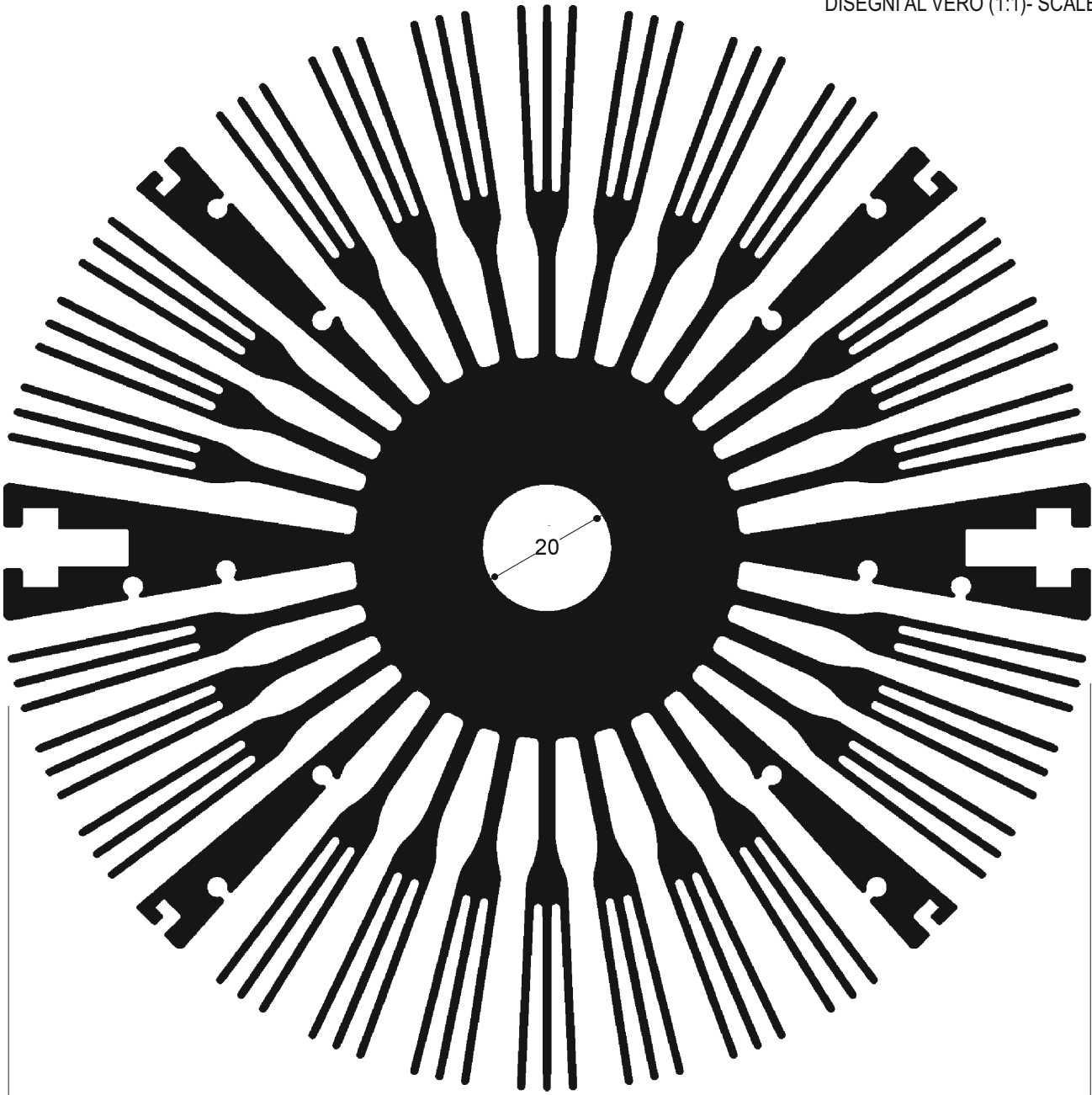

171

517

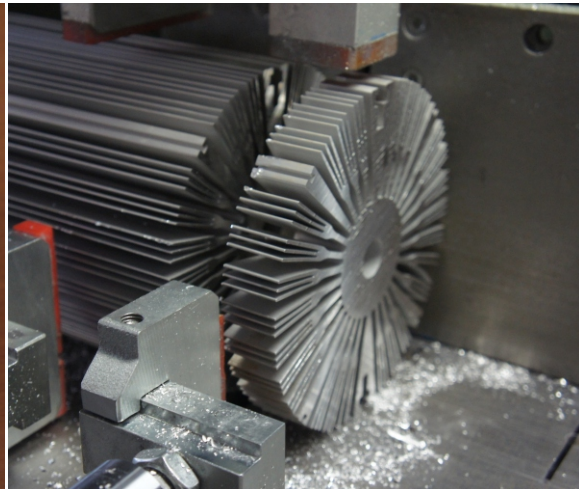
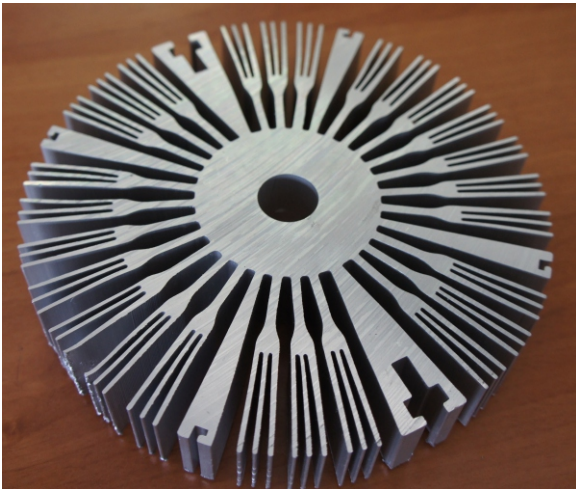

-RIPRODUZIONE VIETATA-  
AGGIORNAMENTO CONTINUO - ED. DEL 05-2015

Cataloghi Online: [www.omar-alluminio.it](http://www.omar-alluminio.it)

[www.omar-alluminio.com](http://www.omar-alluminio.com)

PROFILATI ALLUMINIO A DISEGNO / STANDARD / SPECIALI / E PER:

ELETTRONICA / LED / FOTOVOLTAICO / AUTOMAZIONE ROBOTICA / PNEUMATICA / AUTOMOTIVE

Via Newton, n.12

20016 Pero (Milano - Italy)

Tel. +39 02 3535955 r.a. Fax. +39 02 3539929

E-Mail: [info@omar-alluminio.it](mailto:info@omar-alluminio.it)



# Dissipatori di calore in alluminio per illuminazione a Led

Dissipatori in alluminio estruso lega 6060T5 pronti a magazzino nella versione base:  
-solo fresatura in tondo con vari diametri -grezzi



DISEGNI AL VERO (1:1)- SCALE 1:1

PROFILO ASSEMBLATO: SCHEMA

544

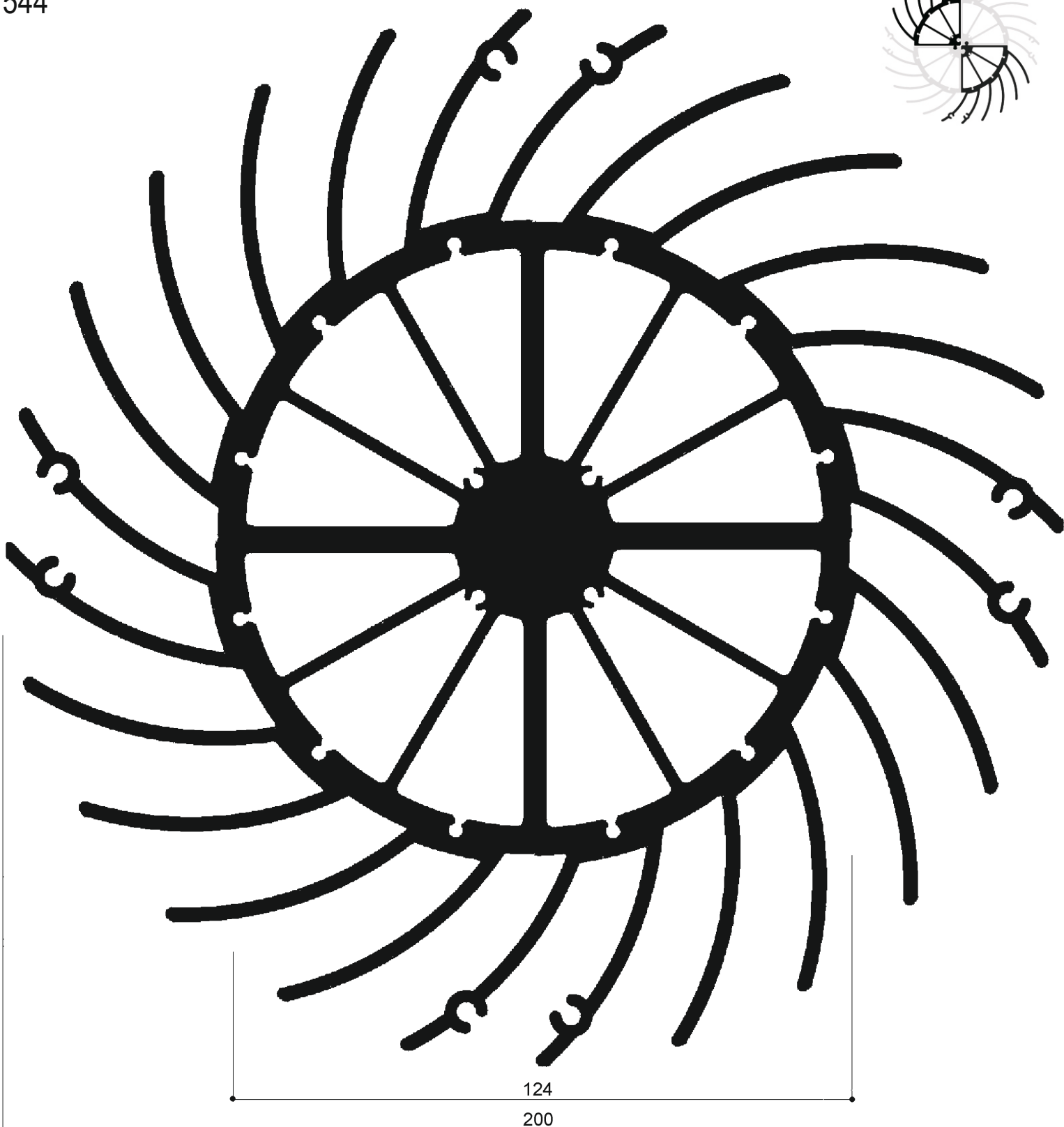
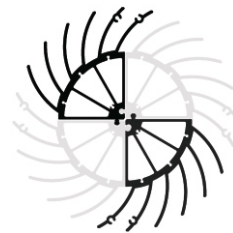



# Dissipatori di calore in alluminio per illuminazione a Led

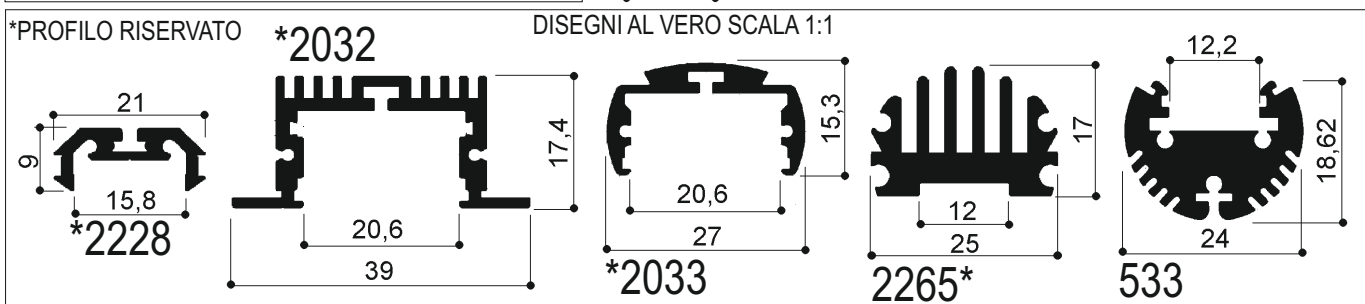
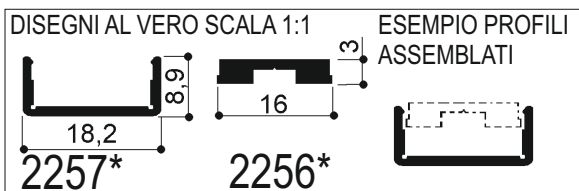
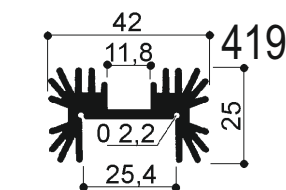
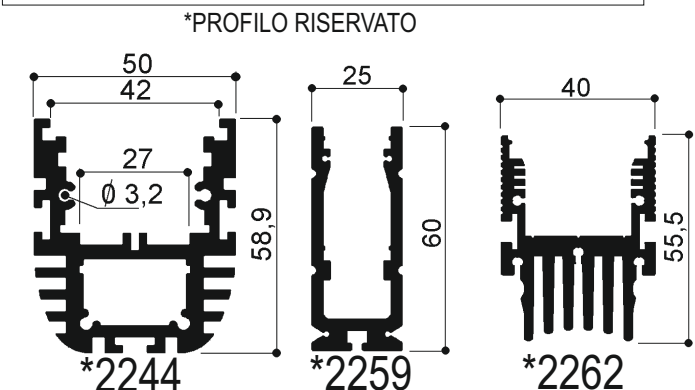
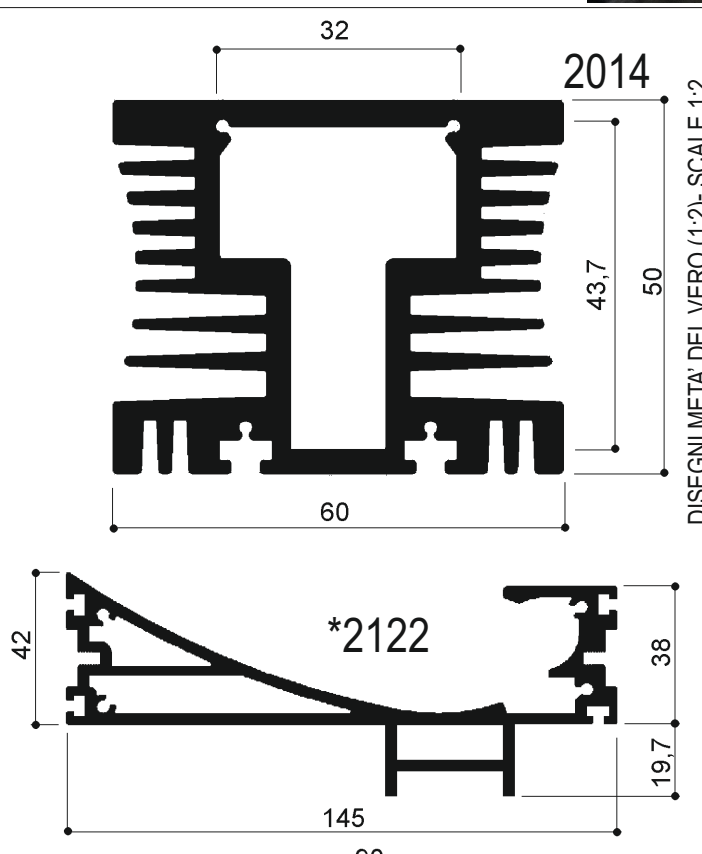
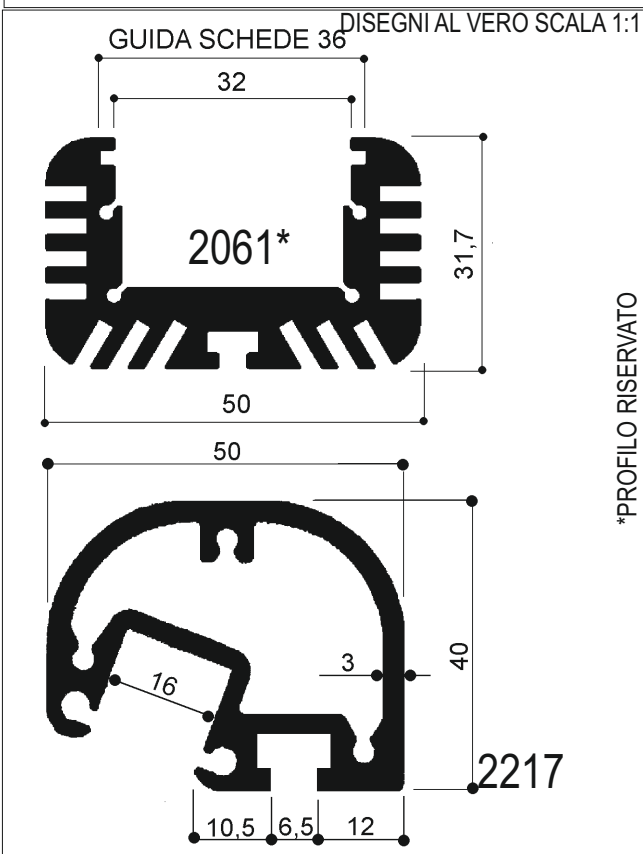
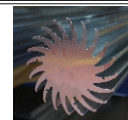

Cataloghi Online: [www.omar-alluminio.it](http://www.omar-alluminio.it)

[www.omar-alluminio.com](http://www.omar-alluminio.com)

PROFILATI ALLUMINIO A DISEGNO / STANDARD / SPECIALI / E PER:

ELETTRONICA / LED / FOTOVOLTAICO / AUTOMAZIONE ROBOTICA / PNEUMATICA / AUTOMOTIVE

Via Newton, n. 12

20016 Pero (Milano - Italy)

Tel. +39 02 3535955 r.a. Fax. +39 02 3539929

E-Mail: [info@omar-alluminio.it](mailto:info@omar-alluminio.it)



# Dissipatori di calore in alluminio per illuminazione a Led



DISEGNI AL VERO SCALA 1:1

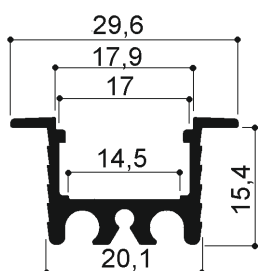

526

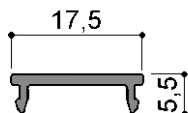

COV526

ESEMPIO PROFILI ASSEMBLATI

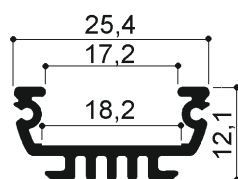

527

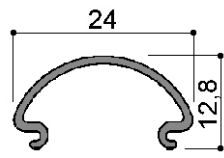

COV527

ESEMPIO PROFILI ASSEMBLATI

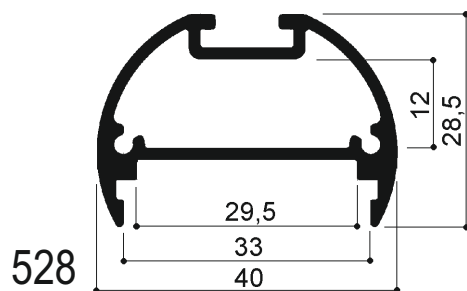
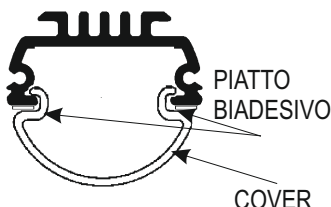

528

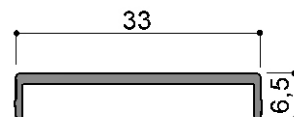

COV528

ESEMPIO PROFILI ASSEMBLATI

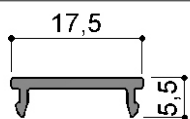
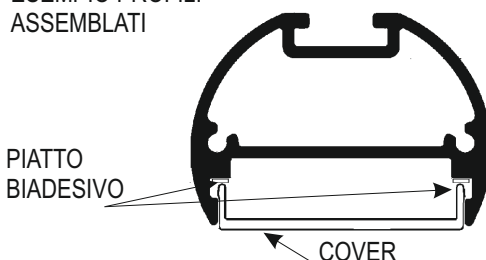

COV526 cover in policarbonato autoestinguente

- COV526-PT: cover trasparente
- COV526-PO: cover opale
- COV526-PST: cover satinato trasparente
- COV526-PSO: cover satinato opale

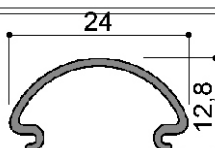

COV527 cover in policarbonato autoestinguente

- COV527-PT: cover trasparente
- COV527-PO: cover opale
- COV527-PST: cover satinato trasparente
- COV527-PSO: cover satinato opale

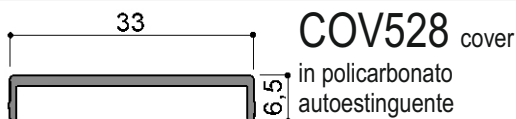

COV528 cover

in policarbonato autoestinguente

- COV528-PT: cover trasparente
- COV528-PO: cover opale
- COV528-PST: cover satinato trasparente
- COV528-PSO: cover satinato opale
- COV528-PTMIC: trasparente microprismato

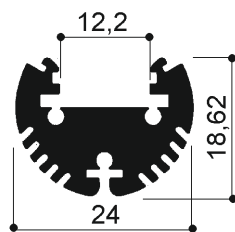

533

COV533 cover in policarbonato autoestinguente

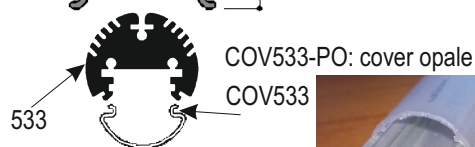

COV533-PO: cover opale

COV533

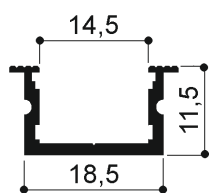

534

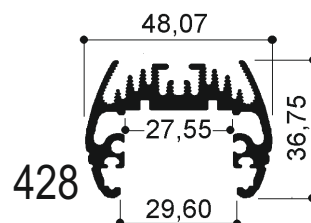

428



# Profili in alluminio per STRISCE A LED



TAPPO CHIUSO IN ABS COLORE ARGENTO PER ART.526 COD.ART.: L-0001



TAPPO CON FORO PASSACAVO IN ABS COLORE ARGENTO PER ART.526 COD.ART.:L-0002



TAPPO CHIUSO IN ABS COLORE ARGENTO PER ART.527 COD.ART.: L-0006

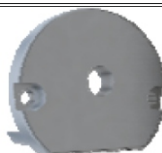

TAPPO CON FORO PASSACAVO IN ABS COLORE ARGENTO PER ART.527 COD.ART.: L-0007



STAFFA DI FISSAGGIO IN ABS COLORE ARGENTO ART.527 COD.ART.: L-0008



STAFFA DI FISSAGGIO ROTANTE REGOLABILE IN ABS COLORE ARGENTO ART.527 COD.ART.: L-0014



TAPPO CHIUSO IN ABS COLORE ARGENTO PER ART.528 COD.ART.:L-0010

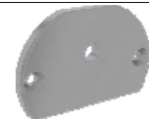

TAPPO CON FORO PASSACAVO IN ABS COLORE ARGENTO PER ART.528 COD.ART.: L-0010



KIT STAFFA PER FISSAGGIO A PARETE/SOSPENSIONE COLORE NERO PER ART.528 COD.ART.: L-0013



PASSA CAVO COD.ART.: L-0012



VITI AUTOFILETTANTI 2,9X9,5 PER FISSAGGIO TAPPO AL PROFILO FM526 E FM528  
CONFEZIONI DA 100PZ COD.ART.: L-0005

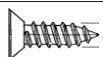

VITI AUTOFILETTANTI 2x6 PER FISSAGGIO TAPPO AL PROFILO FM527  
CONFEZIONI DA 100PZ COD.ART.: L-0009



TAPPO CHIUSO IN ALLUMINIO ANODIZZATO ARGENTO PER ART.533 COD.ART.:L-0015



TAPPO CON FORO PASSACAVO IN ALLUMINIO ANODIZZATO ARGENTO PER ART.528 COD.ART.: L-0016

Cataloghi Online: [www.omar-alluminio.it](http://www.omar-alluminio.it)

[www.omar-alluminio.com](http://www.omar-alluminio.com)

PROFILATI ALLUMINIO A DISEGNO / STANDARD / SPECIALI / E PER:

ELETRONICA / LED / FOTOVOLTAICO / AUTOMAZIONE ROBOTICA / PNEUMATICA / AUTOMOTIVE



Via Newton, n.12

20016 Pero (Milano - Italy)

Tel.:+39 02 3535955 r.a. Fax: +39 02 3539929

E.Mail: [info@omar-alluminio.it](mailto:info@omar-alluminio.it)

# Profili in alluminio per STRISCE A LED ACCESSORI



DISEGNI AL VERO (1:1)- SCALE 1:1

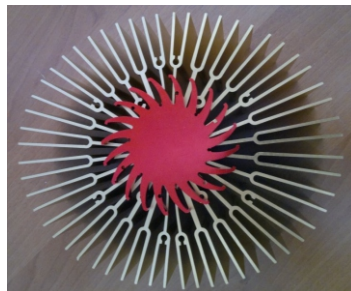
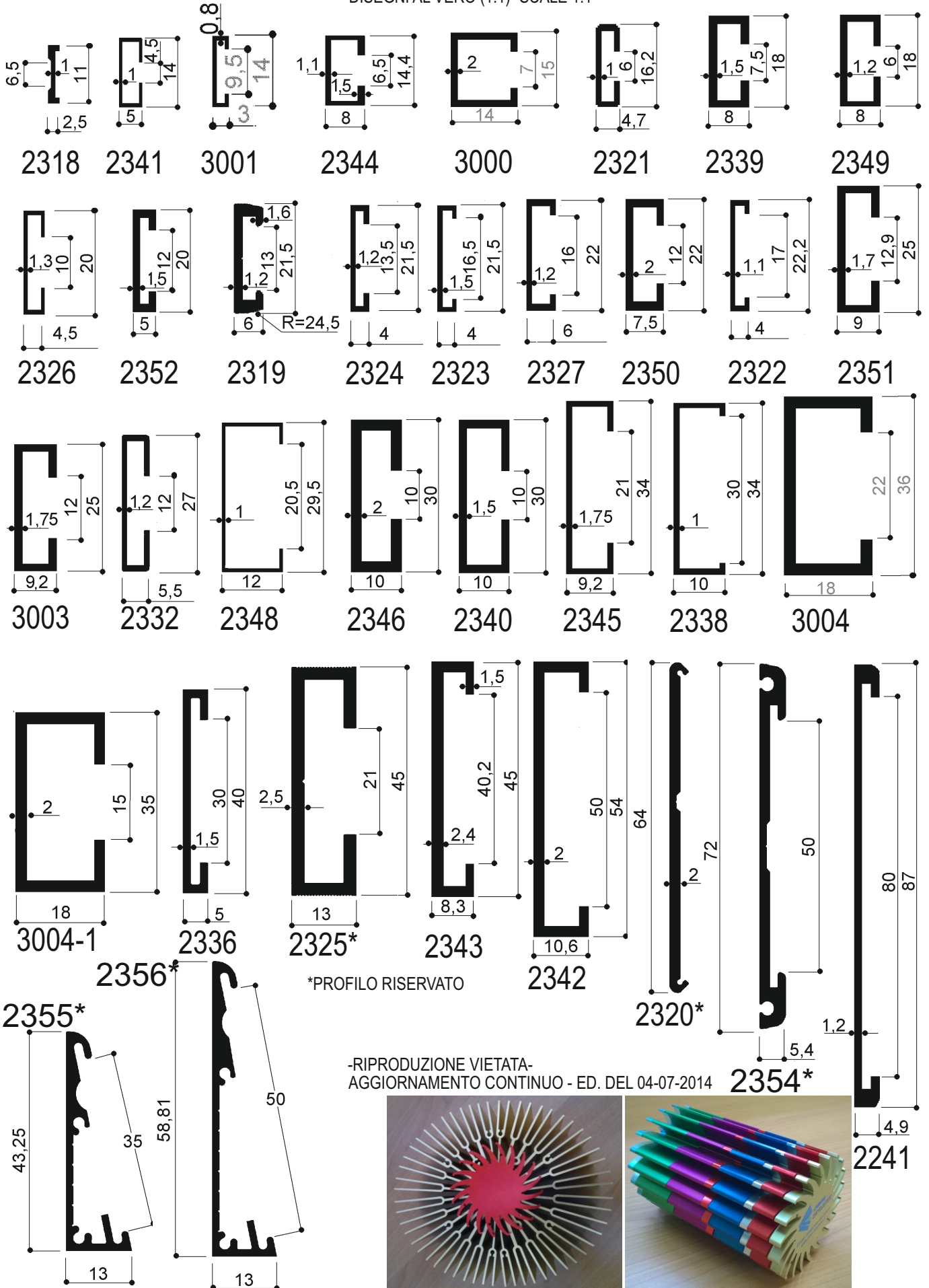

Via Newton, n.12

20016 Pero (Milano - Italy)

Tel. +39 02 3535955 r.a. Fax. +39 02 3539929

E-Mail: info@omar-alluminio.it

Cataloghi Online: www.omar-alluminio.it

www.omar-alluminio.com

PROFILATI ALLUMINIO A DISEGNO / STANDARD / SPECIALI / E PER:

ELETTRONICA / LED / FOTOVOLTAICO / AUTOMAZIONE ROBOTICA / PNEUMATICA / AUTOMOTIVE



# Dissipatori di calore in alluminio per illuminazione a Led



Dissipatori a pettine fresati tonde per LED  
-solo fresatura in tondo con vari diametri -grezzi

DISEGNI META' DEL VERO (1:2)- SCALE 1:2

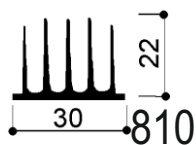

**FRESATURA BARRA**  
DIAMETRO: 27/30mm

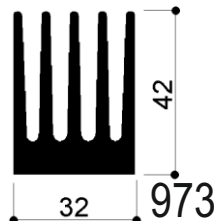
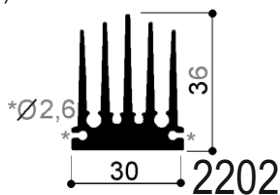

**FRESATURA BARRA**  
DIAMETRO: da 27mm a 32mm

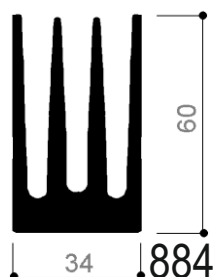
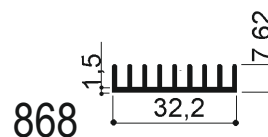

**FRESATURA BARRA**  
DIAMETRO: 34mm

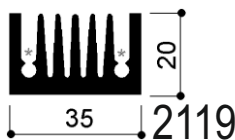

**FRESATURA BARRA**  
DIAMETRO: 27/30/32/35mm

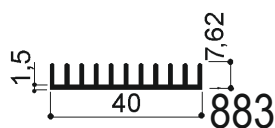
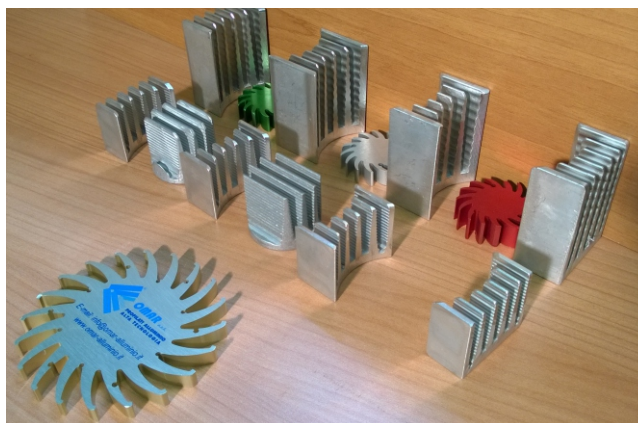

**FRESATURA BARRA**  
DIAMETRO: da 27 a 41/42mm

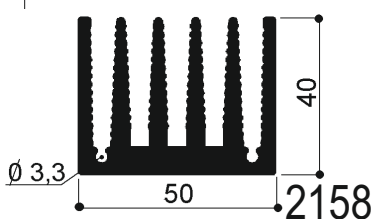
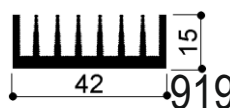
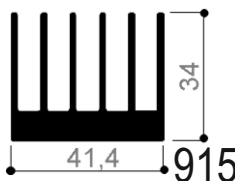

**FRESATURA BARRA**  
DIAMETRO: da 27mm a 50/52mm

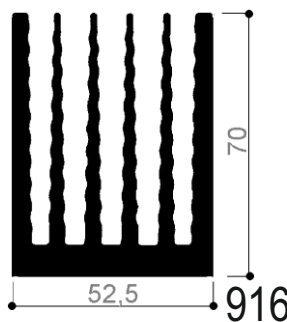
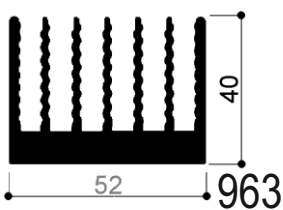

Pag.20L

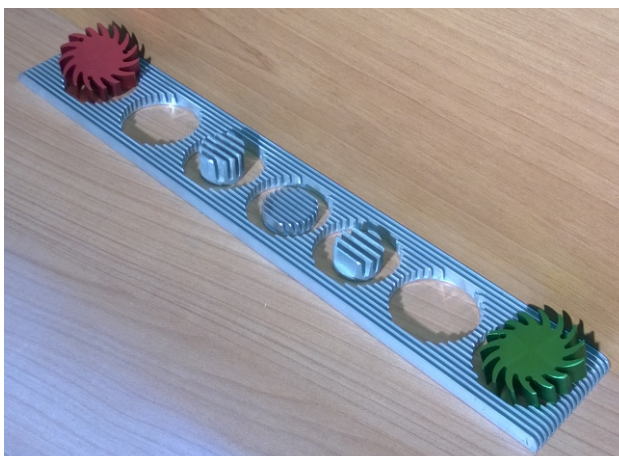
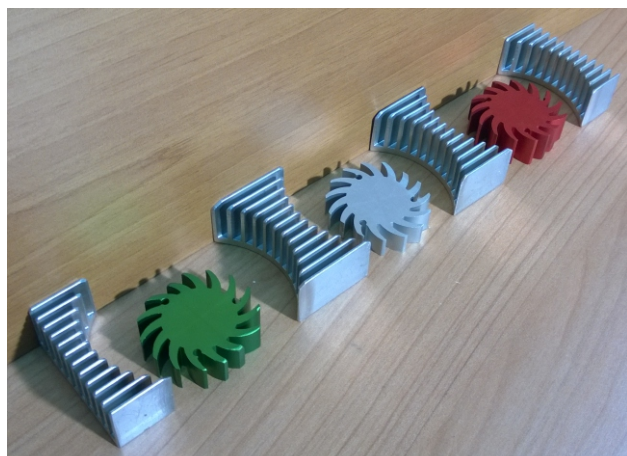

Via Newton, n.12

20016 Pero (Milano - Italy)

Tel. +39 02 3535955 r.a. Fax. +39 02 3539929

E-Mail: info@omar-alluminio.it

Cataloghi Online: [www.omar-alluminio.it](http://www.omar-alluminio.it)

[www.omar-alluminio.com](http://www.omar-alluminio.com)

PROFILATI ALLUMINIO A DISEGNO / STANDARD / SPECIALI / E PER:

ELETTRONICA / LED / FOTOVOLTAICO / AUTOMAZIONE ROBOTICA / PNEUMATICA / AUTOMOTIVE



# Dissipatori di calore in alluminio per illuminazione a Led

Dissipatori a pettine fresati tondi per LED  
-solo fresatura in tondo con vari diametri -grezzi



DISEGNI META' DEL VERO (1:2)- SCALE 1:2

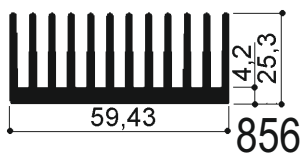

**FRESATURA BARRA**  
DIAMETRO: da 27mm a 60/66mm

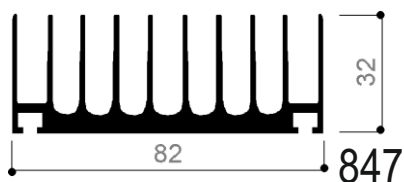
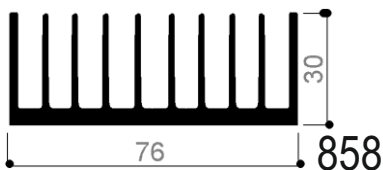
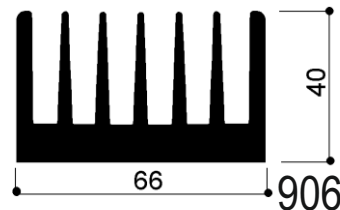
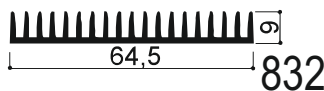

**FRESATURA BARRA**  
DIAMETRO: da 40mm a 76/80/82/84mm

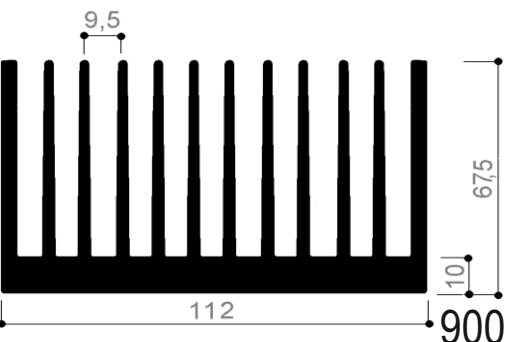
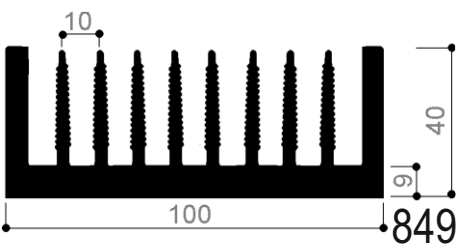
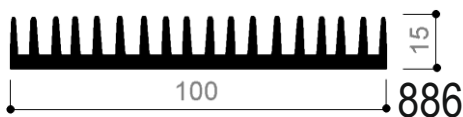

**FRESATURA BARRA**  
DIAMETRO: da 40mm a 112/114mm

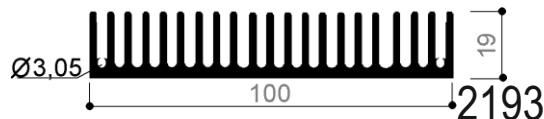
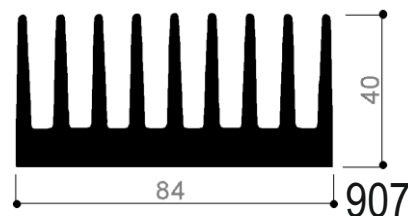
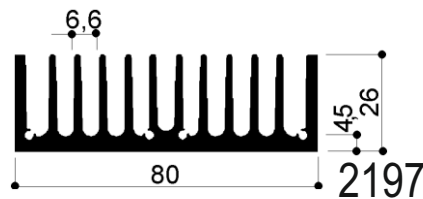

**FRESATURA BARRA**  
DIAMETRO: da 40mm a 100mm

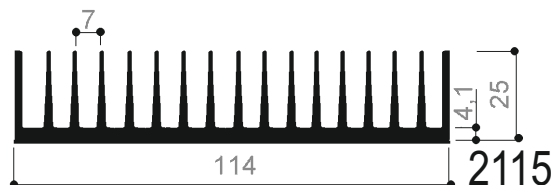
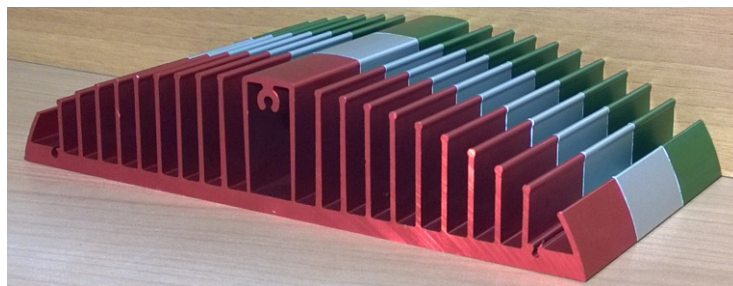

Via Newton, n.12  
20016 Pero (Milano - Italy)  
Tel.+39 02 3535955 r.a. Fax.+39 02 3539929  
E-Mail: info@omar-alluminio.it

Cataloghi Online: [www.omar-alluminio.it](http://www.omar-alluminio.it)  
[www.omar-alluminio.com](http://www.omar-alluminio.com)

PROFILATI ALLUMINIO A DISEGNO / STANDARD / SPECIALI / E PER:  
ELETTRONICA / LED / FOTOVOLTAICO / AUTOMAZIONE ROBOTICA / PNEUMATICA / AUTOMOTIVE

**OMAR** s.r.l.  
PROFILATI ALLUMINIO  
ALTA TECNOLOGIA

# Dissipatori di calore in alluminio per illuminazione a Led

Dissipatori a pettine fresati tonde per LED  
-solo fresatura in tondo con vari diametri -grezzi



DISEGNI META' DEL VERO (1:2)- SCALE 1:2

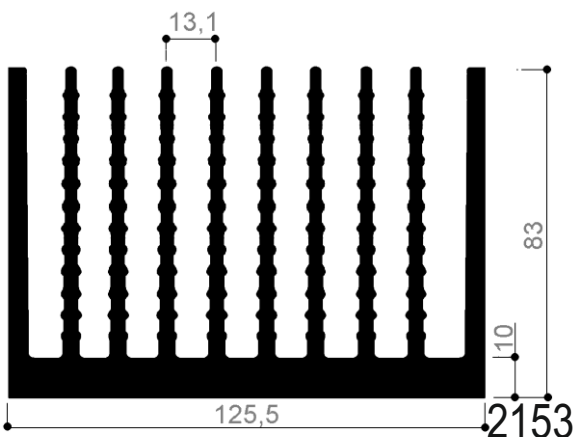
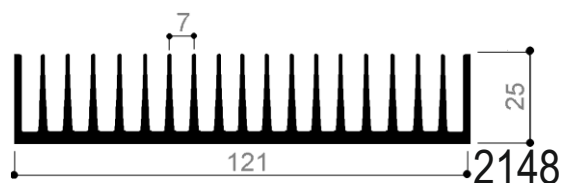
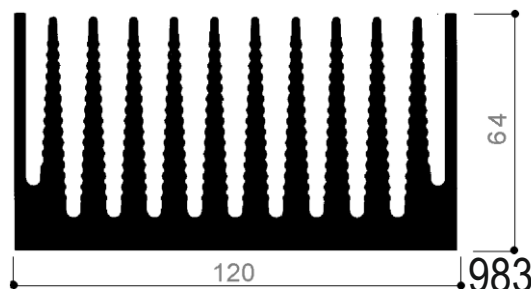
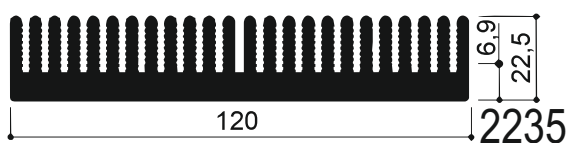

## FRESATURA BARRA

DIAMETRO: da 40mm a 120/121/125mm

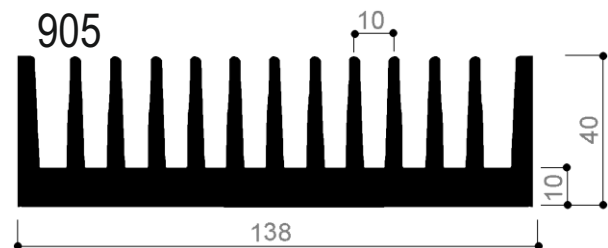
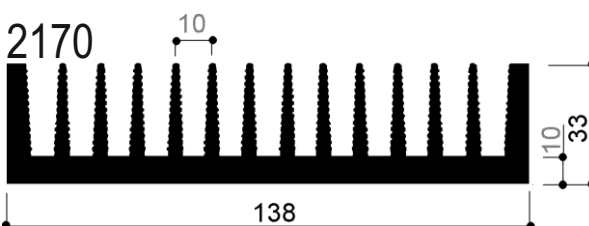
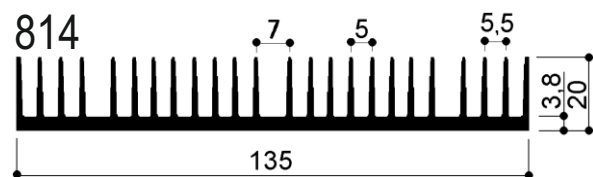

## FRESATURA BARRA

DIAMETRO: da 40mm a 120/125/135/138mm

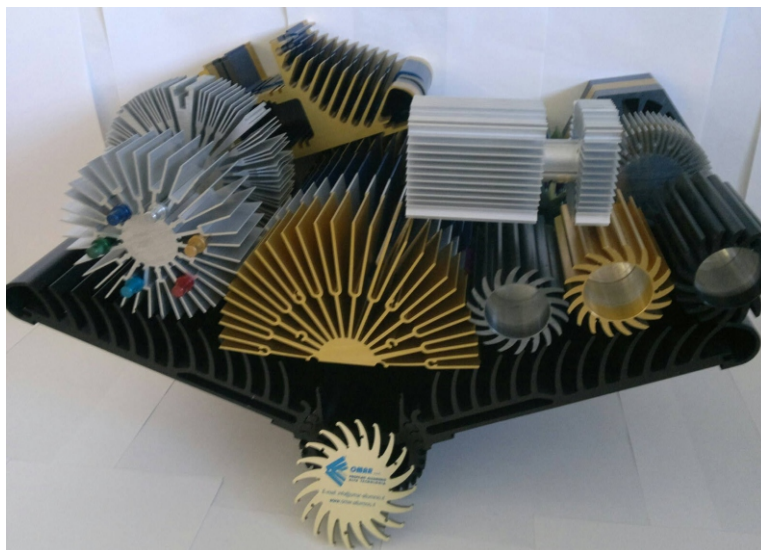

Via Newton, n.12

20016 Pero (Milano - Italy)

Tel. +39 02 3535955 r.a. Fax. +39 02 3539929

E-Mail: info@omar-alluminio.it

Cataloghi Online: [www.omar-alluminio.it](http://www.omar-alluminio.it)

[www.omar-alluminio.com](http://www.omar-alluminio.com)

PROFILATI ALLUMINIO A DISEGNO / STANDARD / SPECIALI / E PER:

ELETTRONICA / LED / FOTOVOLTAICO / AUTOMAZIONE ROBOTICA / PNEUMATICA / AUTOMOTIVE

-RIPRODUZIONE VIETATA-  
AGGIORNAMENTO CONTINUO - ED. DEL 05-2015



# Dissipatori di calore in alluminio per illuminazione a Led

Dissipatori a pettine fresati tondi per LED  
-solo fresatura in tondo con vari diametri -grezzi



DISEGNI META' DEL VERO (1:2)- SCALE 1:2

## FRESATURA BARRA

DIAMETRO: da 40mm a 150/158/160mm

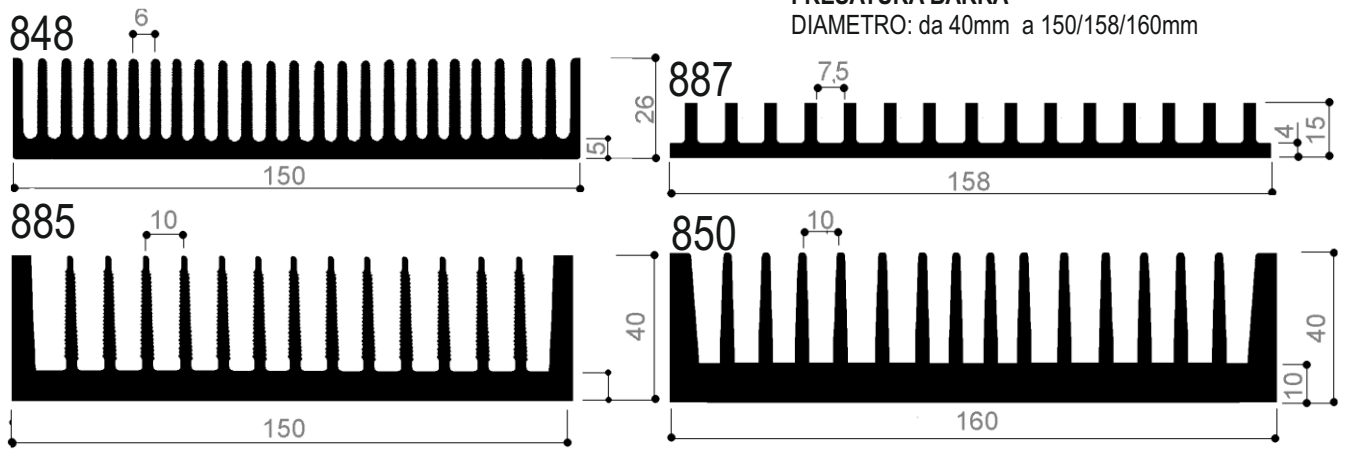

## FRESATURA BARRA

DIAMETRO: da 40mm a 197/200mm

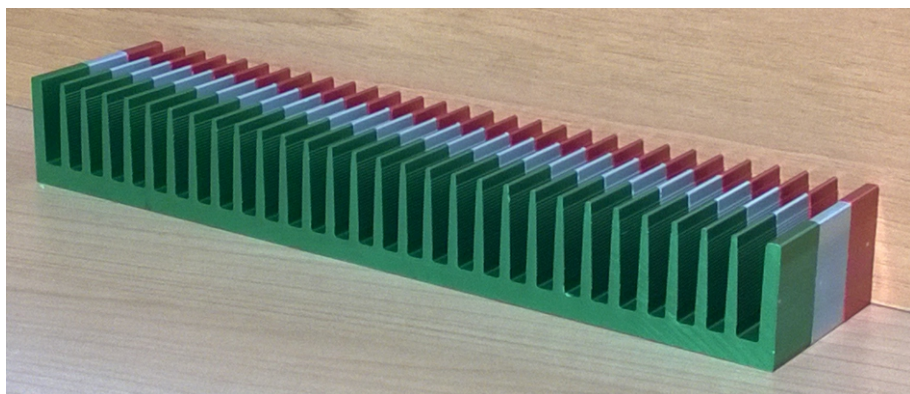
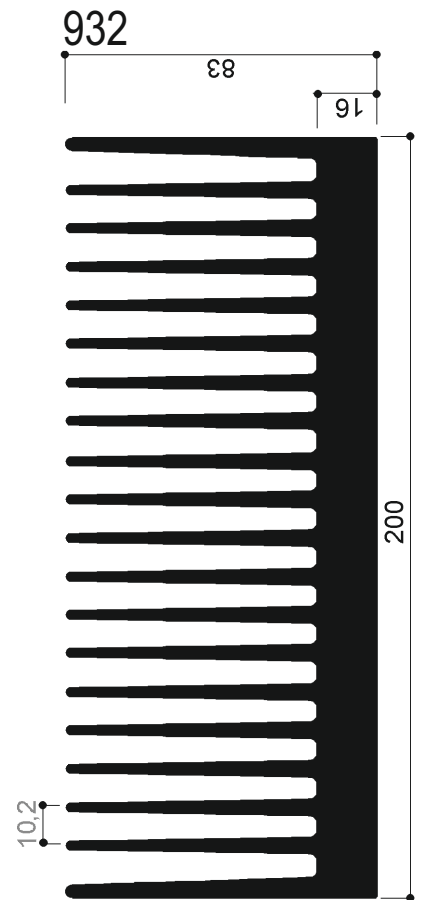
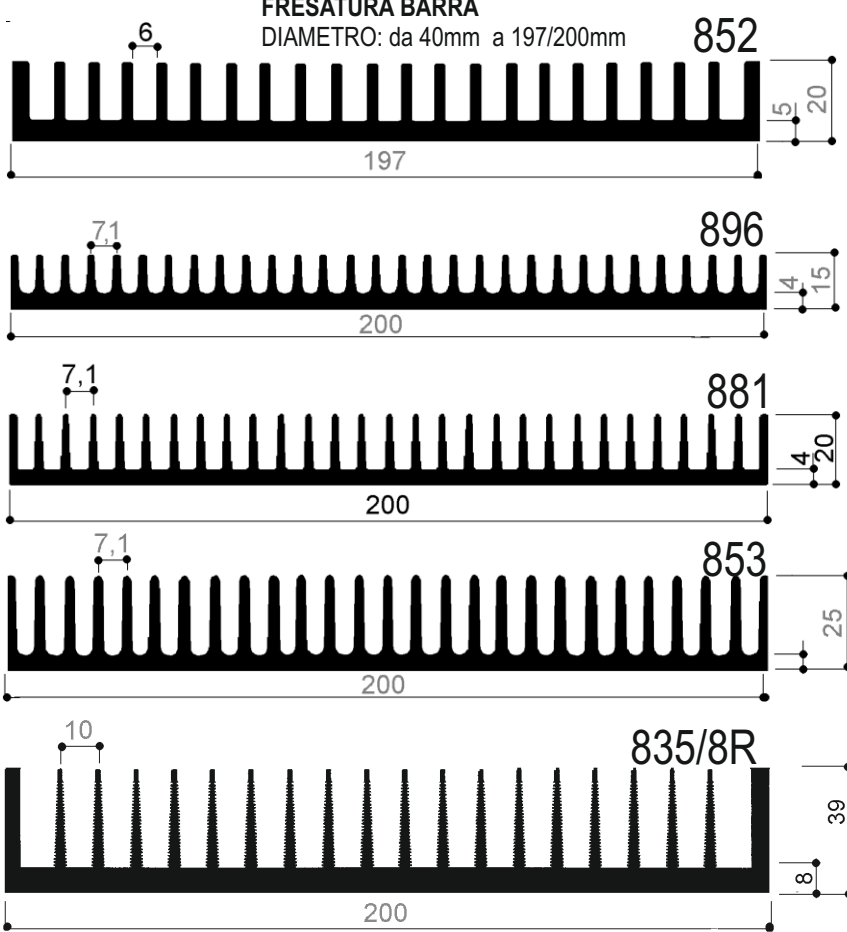

Via Newton, n.12  
20016 Pero (Milano - Italy)  
Tel. +39 02 3535955 r.a. Fax. +39 02 3539929  
E-Mail: info@omar-alluminio.it

Cataloghi Online: [www.omar-alluminio.it](http://www.omar-alluminio.it)  
[www.omar-alluminio.com](http://www.omar-alluminio.com)  
PROFILATI ALLUMINIO A DISEGNO / STANDARD / SPECIALI / E PER:  
ELETTRONICA / LED / FOTOVOLTAICO / AUTOMAZIONE ROBOTICA / PNEUMATICA / AUTOMOTIVE

-RIPRODUZIONE VIETATA-  
AGGIORNAMENTO CONTINUO - ED. DEL 05-2015



# Dissipatori di calore in alluminio per illuminazione a Led

Dissipatori a pettine fresati tonde per LED  
-solo fresatura in tondo con vari diametri -grezzi



DISEGNI META' DEL VERO (1:2)- SCALE 1:2

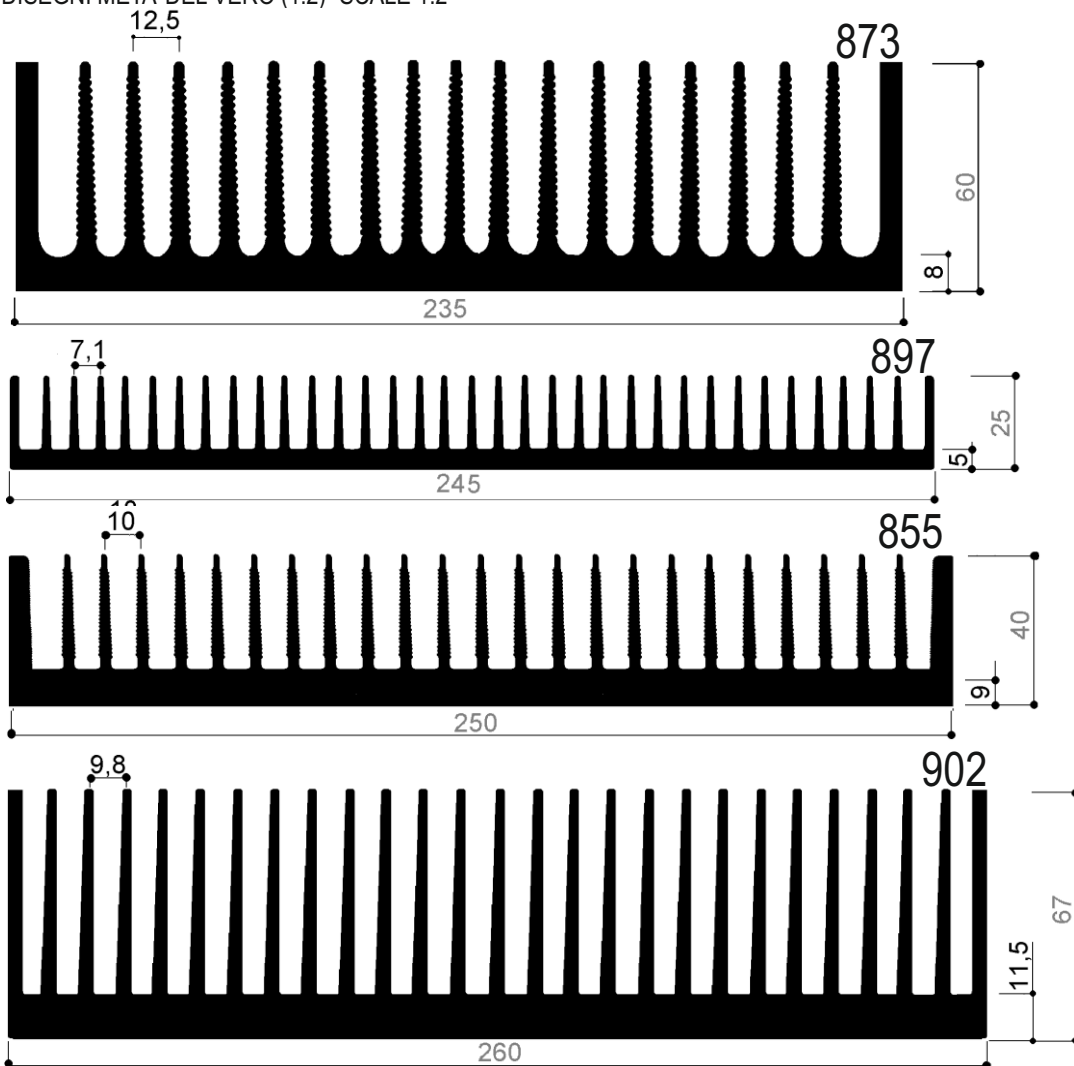

## FRESATURA BARRA

DIAMETRO: da 40mm a 235/245/260mm

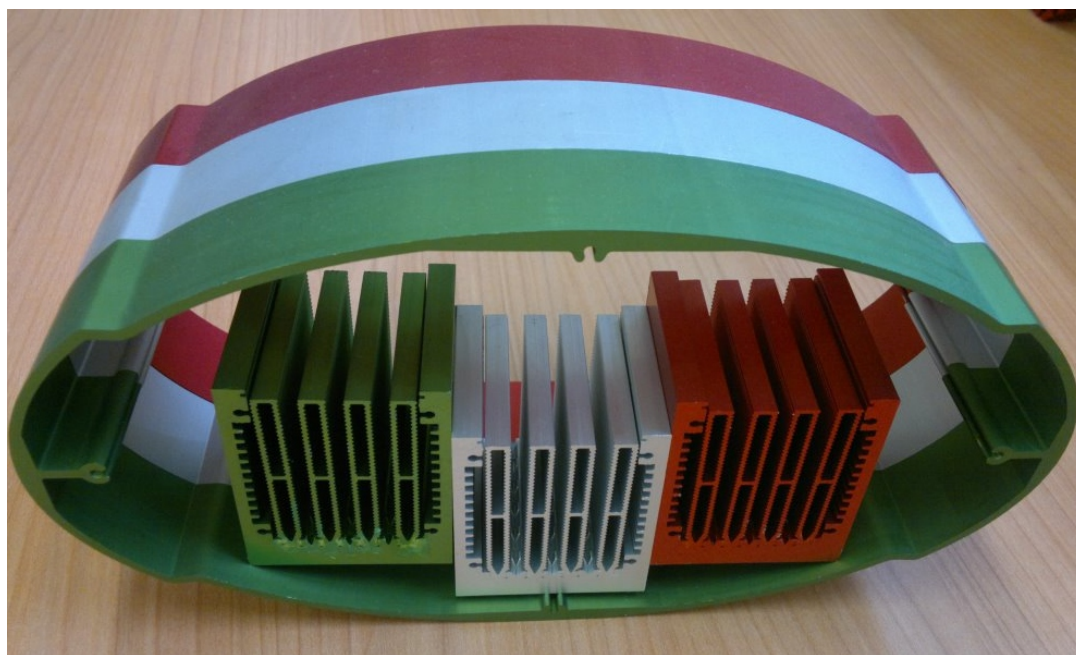

Cataloghi Online: [www.omar-alluminio.it](http://www.omar-alluminio.it)

[www.omar-alluminio.com](http://www.omar-alluminio.com)

PROFILATI ALLUMINIO A DISEGNO / STANDARD / SPECIALI / E PER:

ELETTRONICA / LED / FOTOVOLTAICO / AUTOMAZIONE ROBOTICA / PNEUMATICA / AUTOMOTIVE

Via Newton, n.12

20016 Pero (Milano - Italy)

Tel. +39 02 3535955 r.a. Fax. +39 02 3539929

E-Mail: [info@omar-alluminio.it](mailto:info@omar-alluminio.it)

-RIPRODUZIONE VIETATA-  
-RIPRODUZIONE VIETATA- AGGIORNAMENTO CONTINUO - ED. DEL 05-2015



# Dissipatori di calore in alluminio per illuminazione a Led

Dissipatori a pettine fresati tondi per LED  
-solo fresatura in tondo con vari diametri -grezzi



Via Newton, n.12  
20016 Pero (Milano - Italy)  
Tel. +39 02 3535955 r.a. Fax. +39 02 3539929  
E.Mail: info@omar-alluminio.it

Cataloghi Online: www.omar-alluminio.it  
www.omar-alluminio.com  
PROFILATI ALLUMINIO A DISEGNO / STANDARD / SPECIALI / E PER:  
ELETTRONICA / LED / FOTOVOLTAICO / AUTOMAZIONE ROBOTICA / PNEUMATICA / AUTOMOTIVE

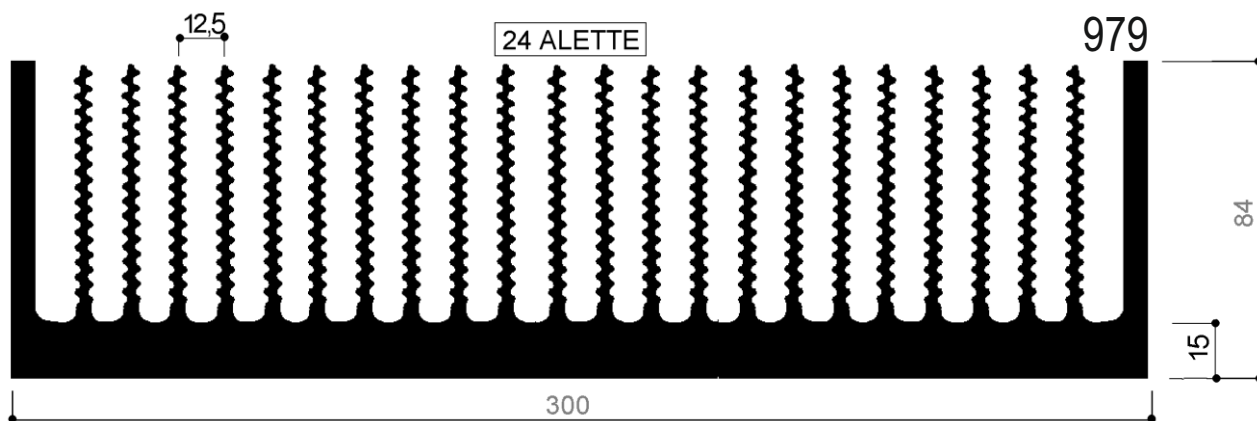
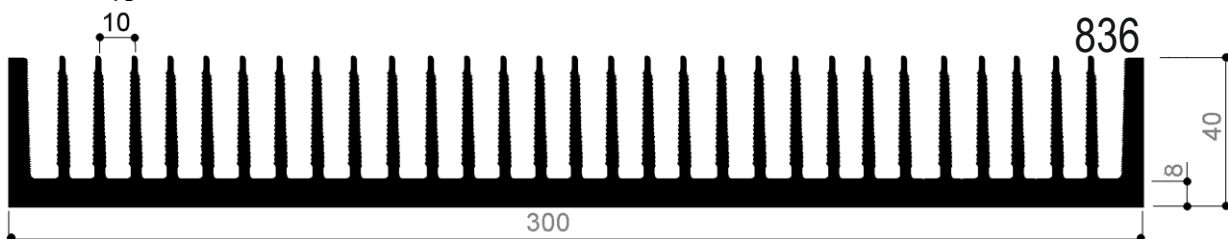
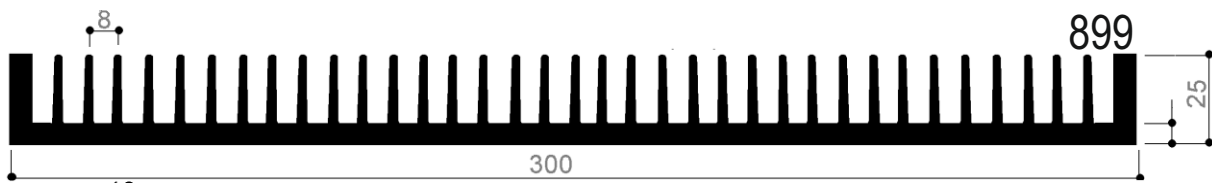

**FRESATURA BARRA**  
DIAMETRO: da 40mm a 300mm

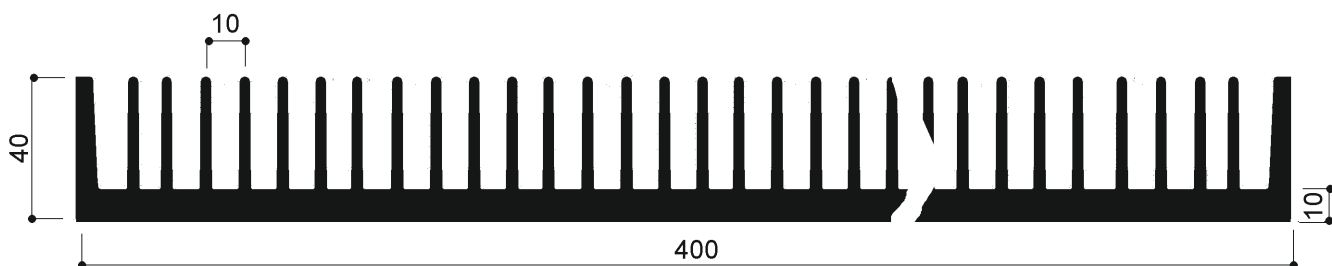

**FRESATURA BARRA**  
DIAMETRO: da 40mm a 400mm

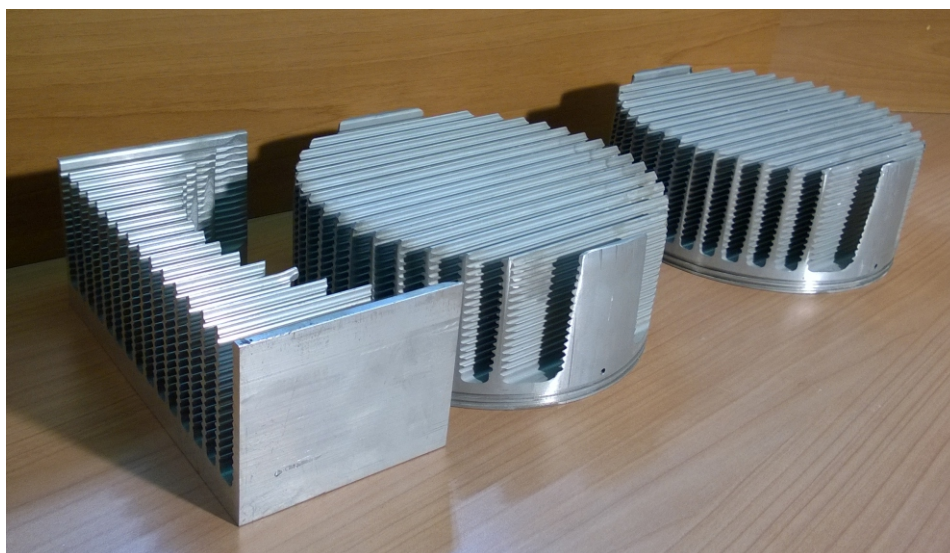

# Dissipatori di calore per sorgenti luminose a LED

Illuminazione allo stato solido - LED

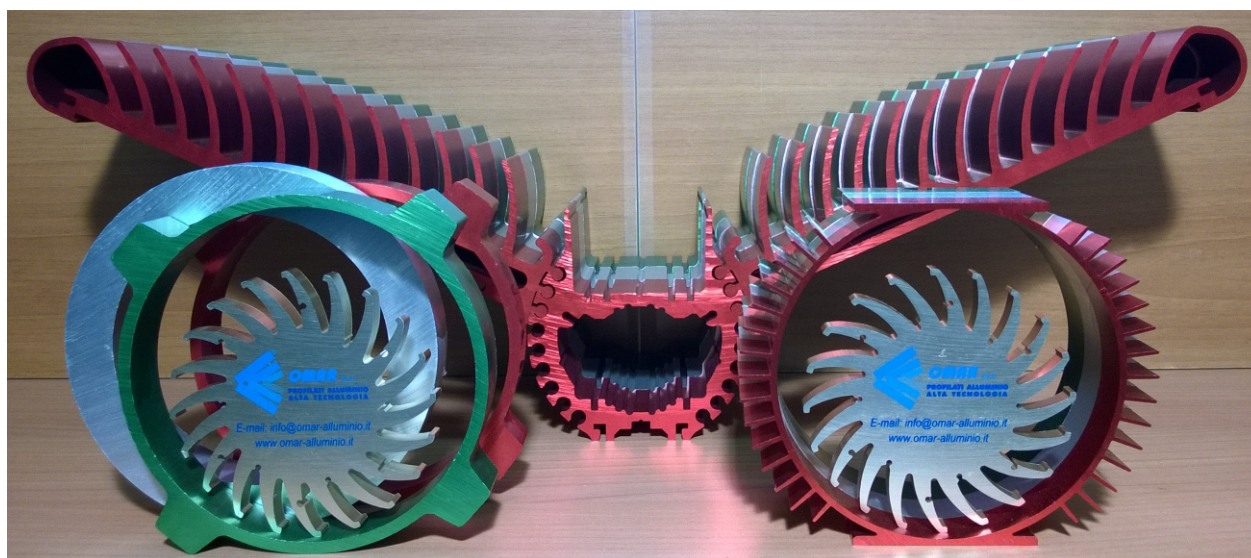
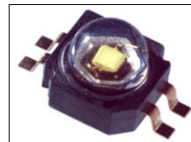

OLTRE AI PROFILI RIPORTATI A CATALOGO SIAMO IN GRADO DI FORNIRE DISSIPATORI IN BARRE CON SAGOME 'CUSTOM' ANCHE PER MODESTI QUANTITATIVI.

TUTTI I PROFILI SONO FORNIBILI NEI SEGUENTI FORMATI:

- BARRE DA 3 / 4 METRI
  - TAGLIATI A MISURA (GREZZI/OSSIDATI)
  - COMPLETAMENTE LAVORATI SECONDO VS. DISEGNO
- WE ARE ABLE TO SUPPLY:
- CUSTOM SECTIONS ALSO FOR LITTLE QUANTITY
  - CUSTOM DRILLINGS

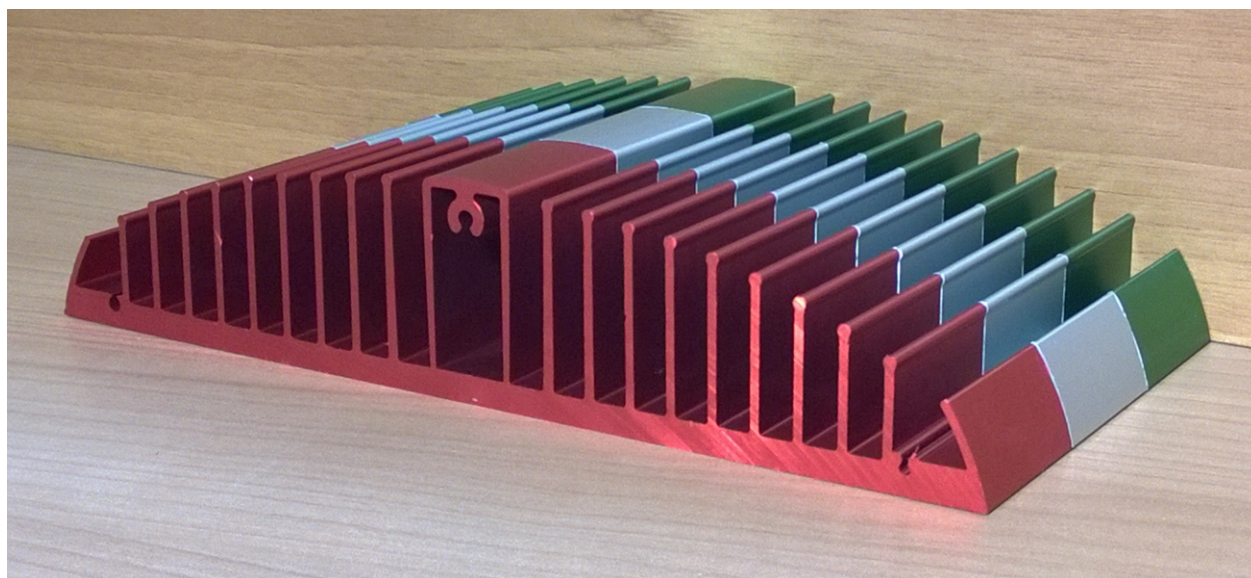

Cataloghi Online: [www.omar-alluminio.it](http://www.omar-alluminio.it)

[www.omar-alluminio.com](http://www.omar-alluminio.com)

PROFILATI ALLUMINIO A DISEGNO / STANDARD / SPECIALI / E PER:

ELETTRONICA / LED / FOTOVOLTAICO / AUTOMAZIONE ROBOTICA / PNEUMATICA / AUTOMOTIVE



Via Newton, n.12

20016 Pero (Milano - Italy)

Tel. +39 02 3535955 r.a. Fax. +39 02 3539929

E-Mail: [info@omar-alluminio.it](mailto:info@omar-alluminio.it)

# FIERA MILANO RHO - PERO

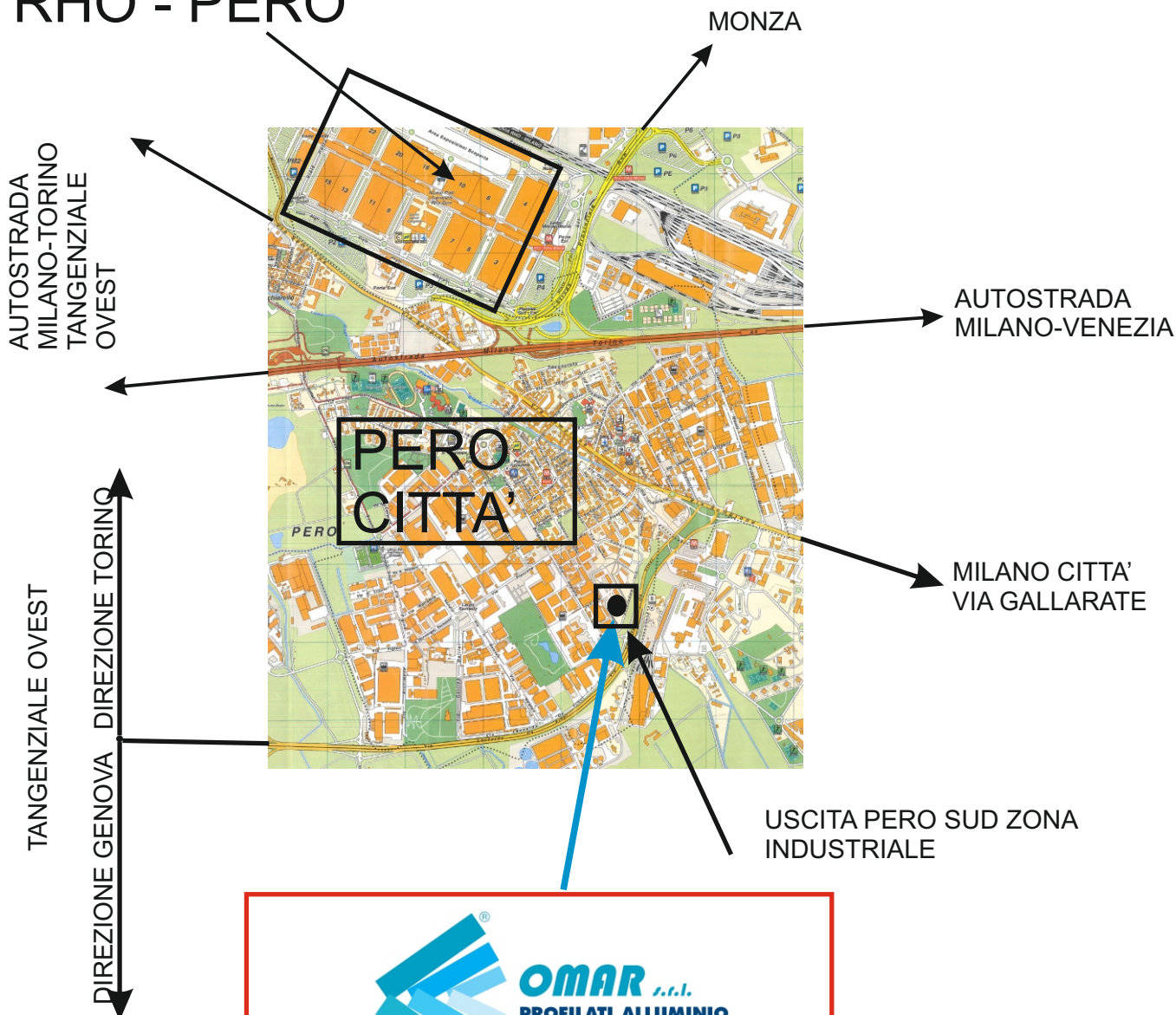

**Via Newton, n.12**  
**20016 Pero (Milano - Italy)**  
**Tel.+39 02 3535955 r.a.**  
**Fax.+39 02 3539929**  
**E.Mail: info@omar-alluminio.it**

Consultate il ns. catalogo aggiornato online all'indirizzo:

[www.omar-alluminio.it](http://www.omar-alluminio.it)

[www.omar-alluminio.com](http://www.omar-alluminio.com)

[www.omar-alluminio.eu](http://www.omar-alluminio.eu)

PROFILATI IN ALLUMINIO  
A DISEGNO-STANDARD-SPECIALI



E PER: ELETTRONICA-LED-FOTOVOLTAICO  
AUTOMAZIONE ROBOTICA-PNEUMATICA-AUTOMOTIVE