

- ° Custom and standard shapes aluminium profiles
- ° Aluminum heatsink cut to length or Raw Bar
- ° high-dissipation aluminium profiles heat sinks
- ° LED aluminium extrusion profiles heat sinks
- ° CNC Machining Parts
- ° Aluminum Electronics Enclosures Instrument panel enclosures
- ° Modular structural aluminium profiles

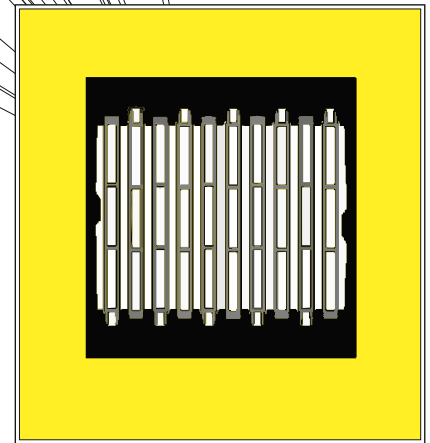
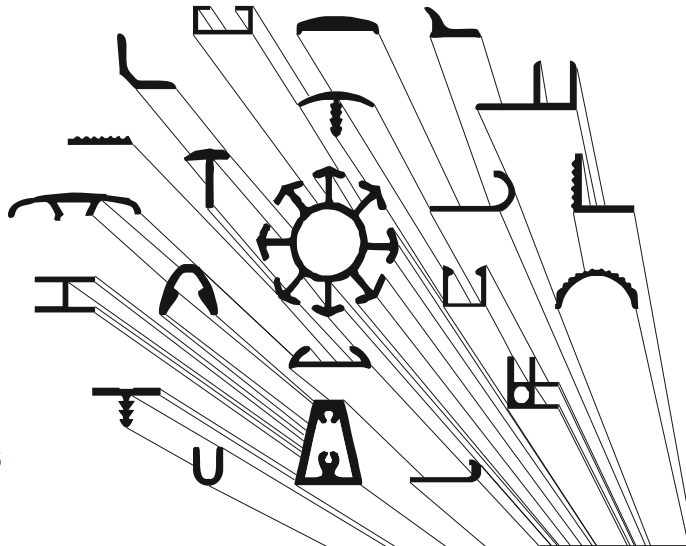

Le "molte forme" della billetta d'alluminio

Dissipatori di calore
ad ALTO RENDIMENTO

Edizione Febbraio 2017

Consultate il catalogo aggiornato
online su:

www.omar-alluminio.it

www.omar-alluminio.com

www.dissipatori.com

- ° Profilati per pneumatica
- ° Profilati per stand
- ° Profilati per battiscopa copri fili zoccolini
- ° Prodotti derivati da profili di alluminio
- ° Lavorazione meccanica profili di alluminio

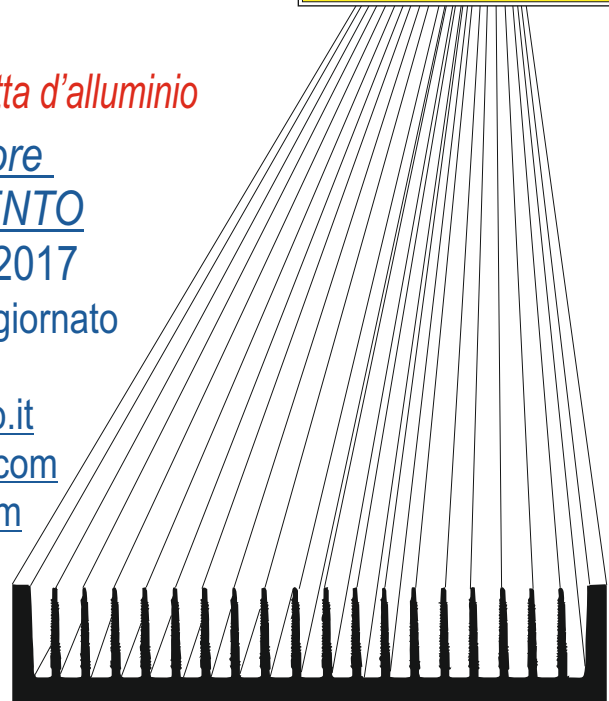

Via Newton, n.12
20016 Pero (Milano - Italy)
Tel. +39 02 3535955 r.a.
Fax. +39 02 3539929
E.Mail: info@omar-alluminio.it

PROFILATI IN ALLUMINIO
A DISEGNO-STANDARD-SPECIALI



E PER: ELETTRONICA-LED-FOTOVOLTAICO
AUTOMAZIONE-ROBOTICA-PNEUMATICA-AUTOMOTIVE

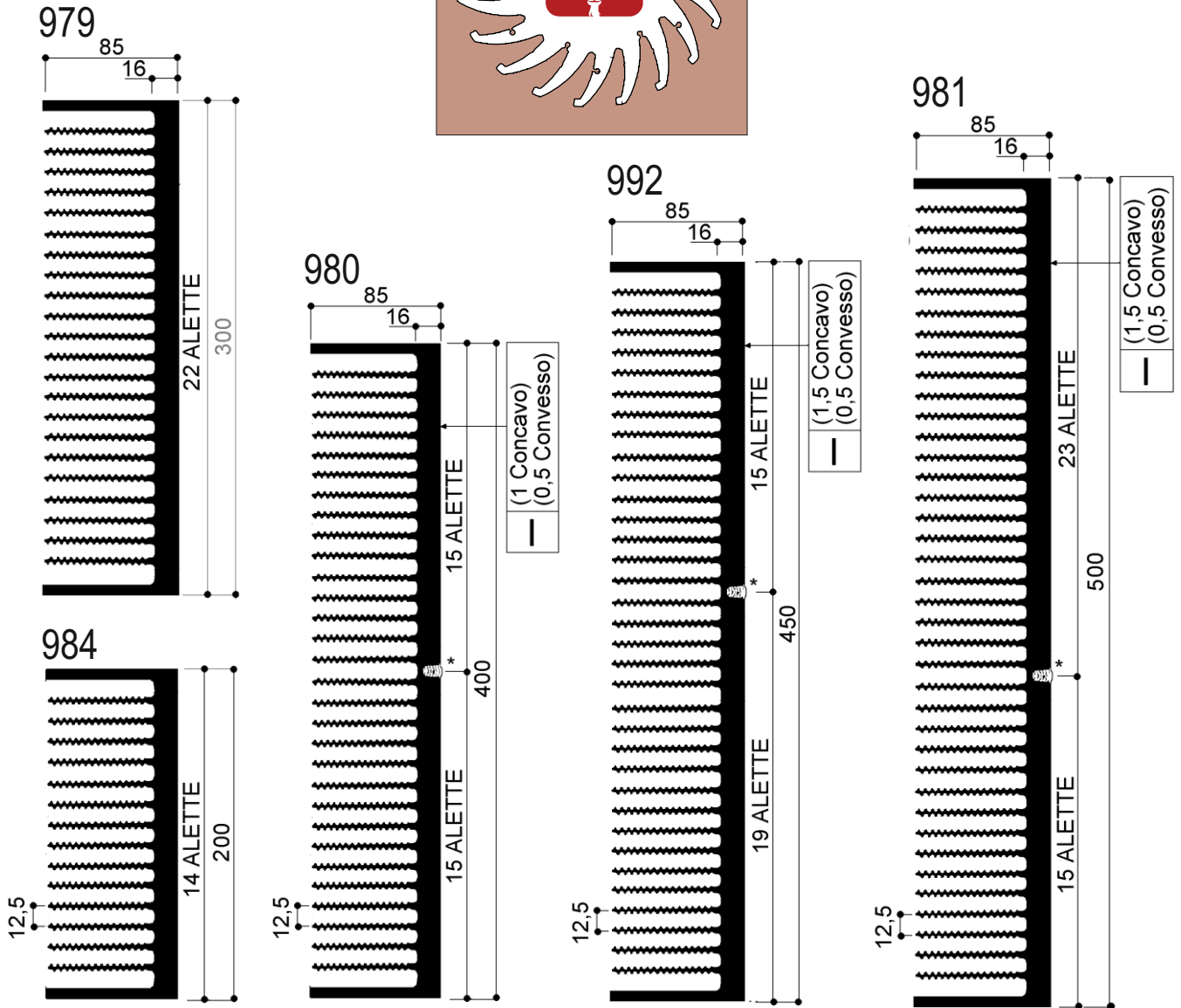
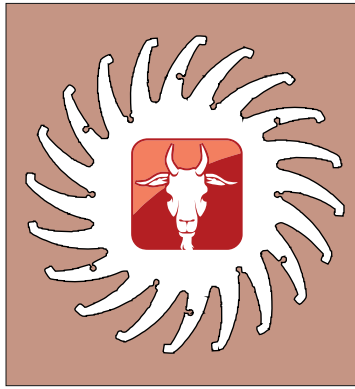

SALDATURA IN ACCORDO ALLA NORMA EN288-4:1992 / A1:1997

WELDING PROCESS ACCORDING TO EN288-4:1992 / A1:1997

*CORDONE DI SALDATURA - WELDING WIRE

**PROFILATI
ALLUMINIO**
Ottone - Rame



OLTRE AI PROFILI RIPORTATI A CATALOGO PRONTI A MAGAZZINO SIAMO IN GRADO DI FORNIRE DISSIPATORI IN BARRE CON SAGOME 'CUSTOM' ANCHE PER MODESTI QUANTITATIVI.

TUTTI I PROFILI SONO FORNIBILI NEI SEGUENTI FORMATI:

- BARRE DA 3 / 4 METRI
- TAGLIATI A MISURA (GREZZI/OSSIDATI)
- COMPLETAMENTE LAVORATO SECONDO VS. DISEGNO

WE ARE ABLE TO SUPPLY:

- CUSTOM SECTIONS ALSO FOR LITTLE QUANTITY
- CUSTOM DRILLINGS

FOTO DI ESEMPIO:
DISSIPATORI TONDI RICAVATI
DA BARRA MEDIANTE
FRESATURA

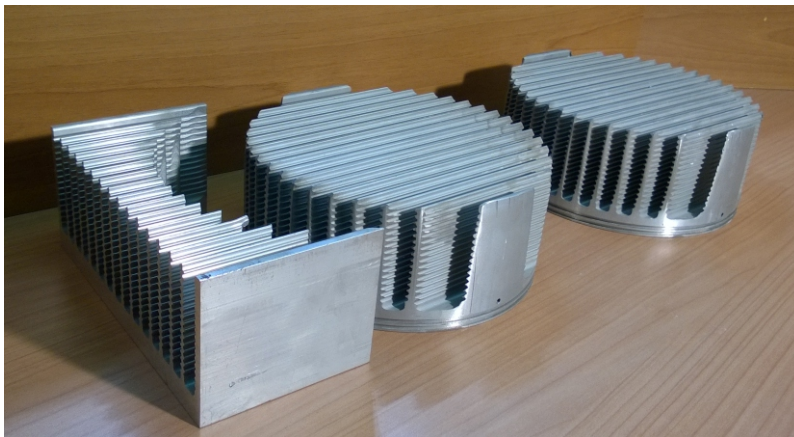

SALDATURA IN ACCORDO ALLA NORMA EN288-4:1992 / A1:1997
WELDING PROCESS ACCORDING TO EN288-4:1992 / A1:1997
*CORDONE DI SALDATURA - WELDING WIRE

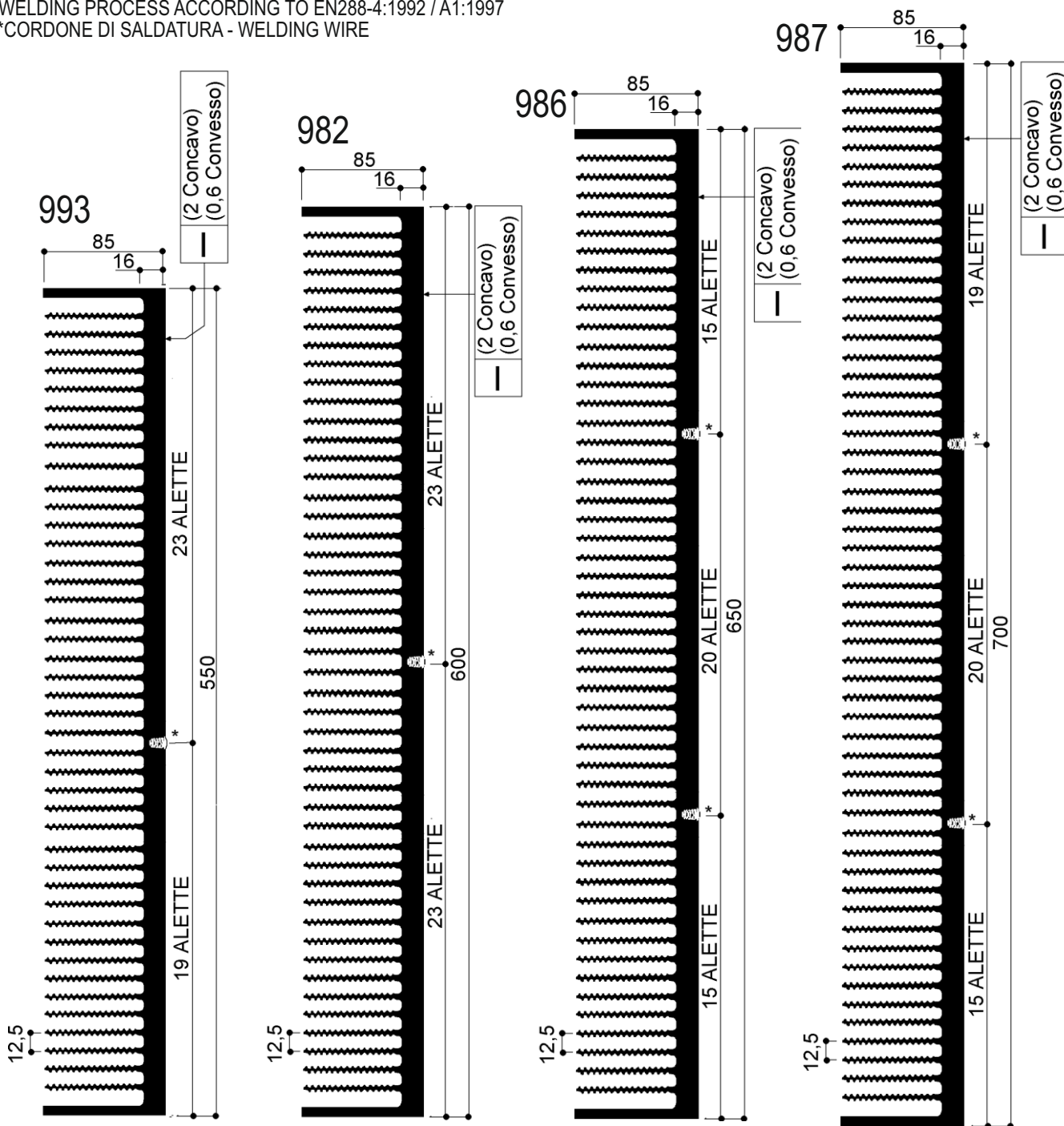

Cataloghi Online: www.omar-alluminio.it
www.omar-alluminio.com

PROFILATI ALLUMINIO A DISEGNO / STANDARD / SPECIALI / E PER:
ELETTRONICA / LED / FOTOVOLTAICO / AUTOMAZIONE ROBOTICA / PNEUMATICA / AUTOMOTIVE



Via Newton, n.12
20016 Pero (Milano - Italy)
Tel. +39 02 3535955 r.a. Fax. +39 02 3539929
E-Mail: info@omar-alluminio.it

SALDATURA SECONDO NORME EN288-4:1992 / A1:1997
 WELDING PROCESS ACCORDING TO EN288-4:1992 / A1:1997

*CORDONE DI SALDATURA - WELDING WIRE

Cataloghi Online: www.omar-alluminio.it
www.omar-alluminio.com

PROFILATI ALLUMINIO A DISEGNO / STANDARD / SPECIALI / E PER:

ELETTRONICA / LED / FOTOVOLTAICO / AUTOMAZIONE ROBOTICA / PNEUMATICA / AUTOMOTIVE

Via Newton, n.12
 20016 Pero (Milano - Italy)
 Tel. +39 02 3535955 r.a. Fax. +39 02 3539929
 E.Mail: info@omar-alluminio.it

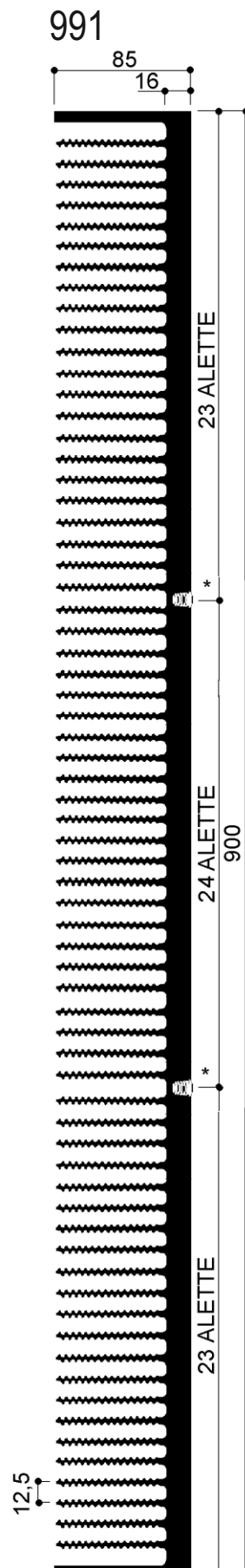
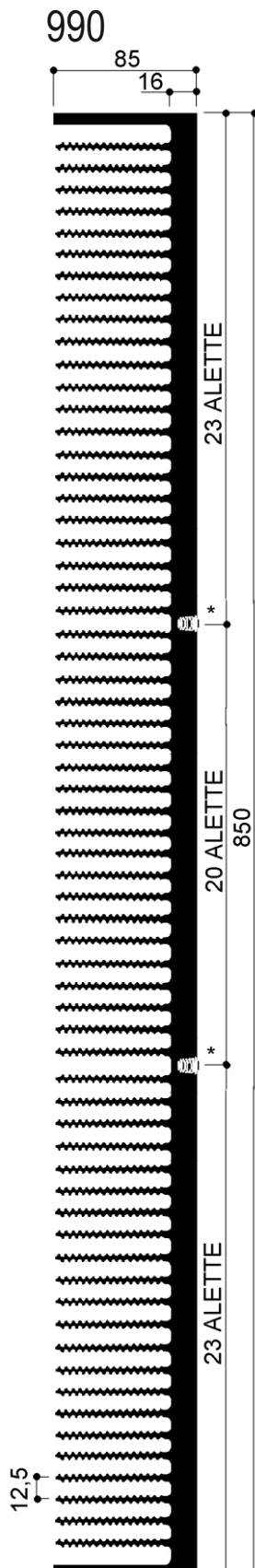
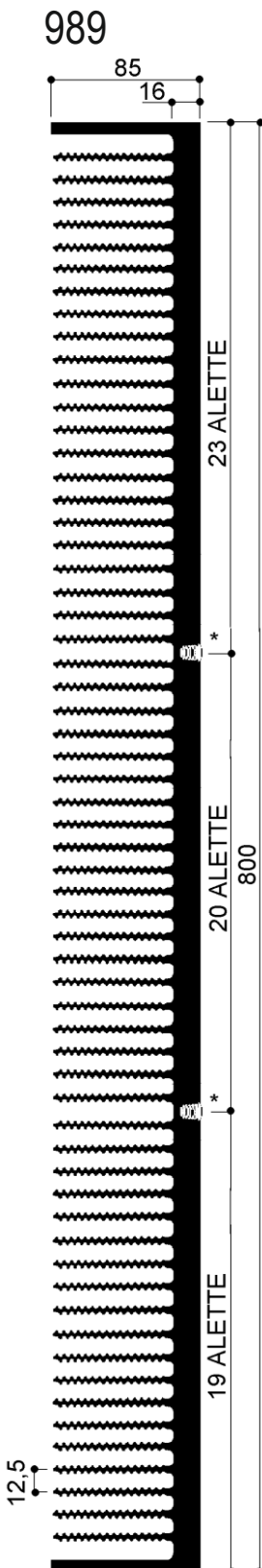
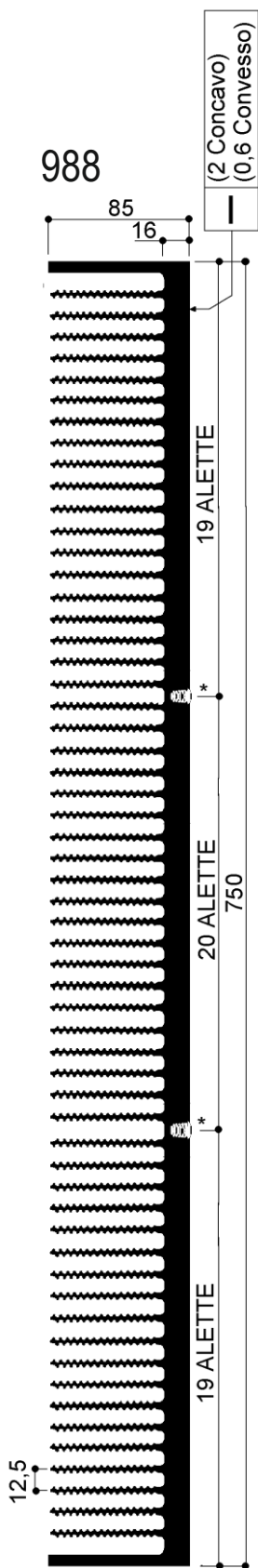

DISSIPATORI AD ALTO RENDIMENTO

DISEGNI META' DEL VERO (1:2)- SCALE 1:2

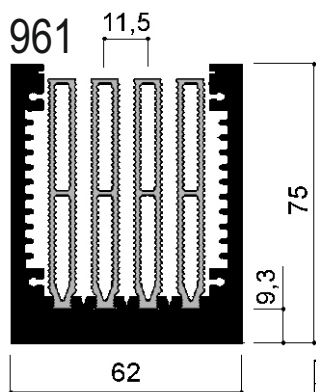

Resistenza termica (KW) in ventilazione forzata

Lg. (mm)	100	200	300
R _{th} a 5m/s	0,23	0,18	0,14

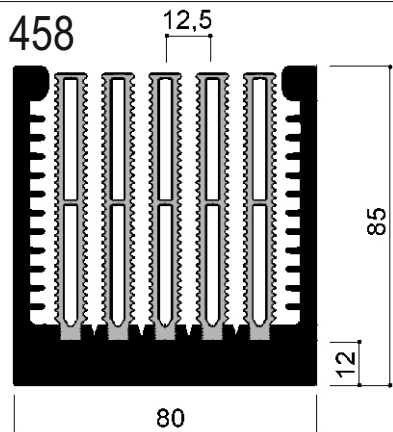
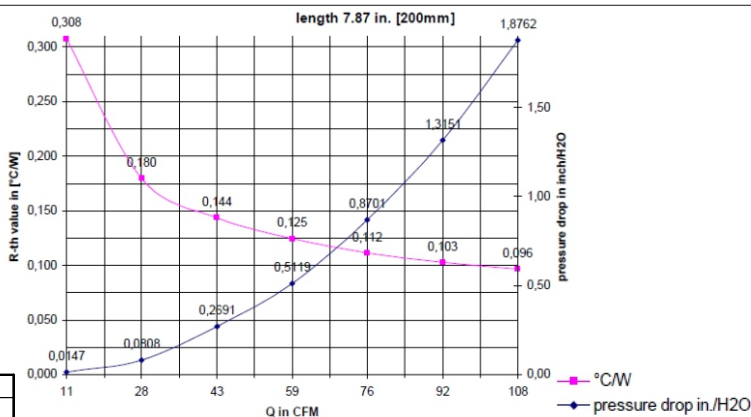

Resistenza termica (KW) in ventilazione forzata

Lg. (mm)	100	200	300
R _{th} a 5m/s	0,165	0,13	0,1

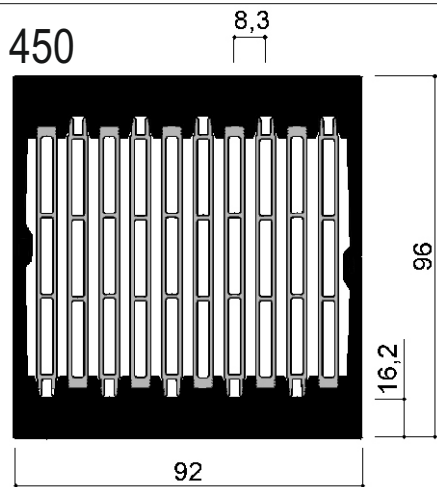
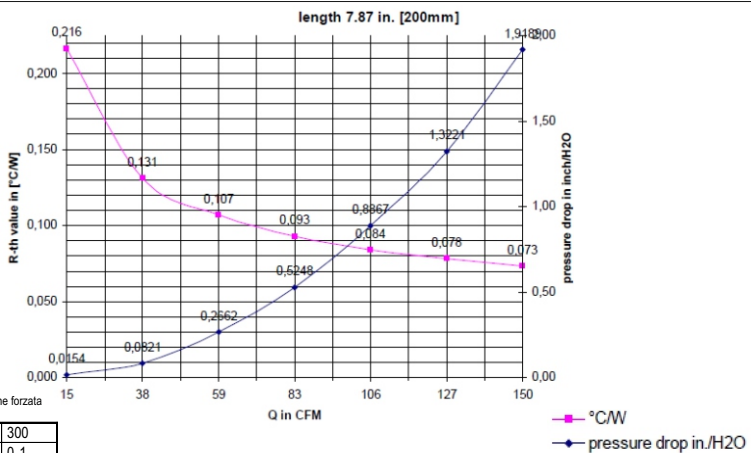

Resistenza termica (KW) in ventilazione forzata

Lg. (mm)	100	200	300
R _{th} a 5m/s	0,13	0,1	0,08

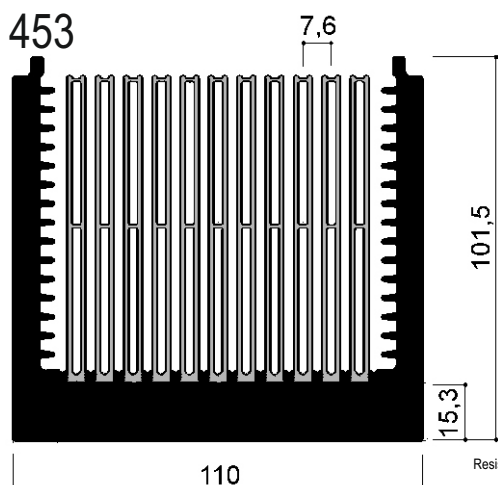
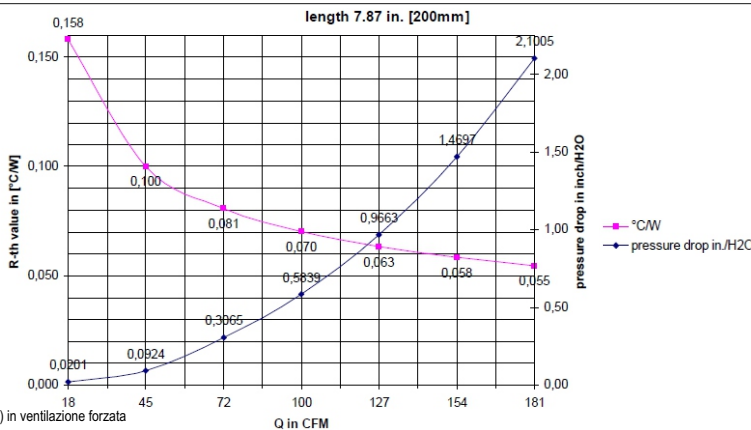

Resistenza termica (KW) in ventilazione forzata

Lg. (mm)	100	200	300
R _{th} a 11 m/s	0,0915	0,0579	0,0450

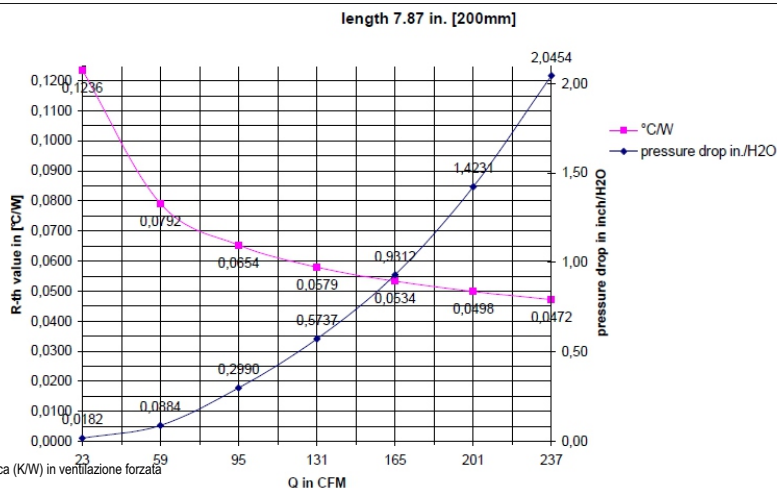

Via Newton, n.12

20016 Pero (Milano - Italy)

Tel. +39 02 3535955 r.a. Fax. +39 02 3539929

E-Mail: info@omar-alluminio.it

Cataloghi Online: www.omar-alluminio.it

www.omar-alluminio.com

PROFILATI ALLUMINIO A DISEGNO / STANDARD / SPECIALI / E PER:

ELETTRONICA / LED / FOTOVOLTAICO / AUTOMAZIONE ROBOTICA / PNEUMATICA / AUTOMOTIVE



DISSIPATORI AD ALTO RENDIMENTO

DISEGNI META' DEL VERO (1:2)- SCALE 1:2



Via Newton, n.12
20016 Pero (Milano - Italy)
Tel. +39 02 3535955 r.a. Fax. +39 02 3539929
E. Mail: info@omar-alluminio.it

Cataloghi Online: www.omar-alluminio.it
www.omar-alluminio.com
PROFILATI ALLUMINIO A DISEGNO / STANDARD / SPECIALI / E PER:
ELETTRONICA / LED / FOTOVOLTAICO / AUTOMAZIONE ROBOTICA / PNEUMATICA / AUTOMOTIVE

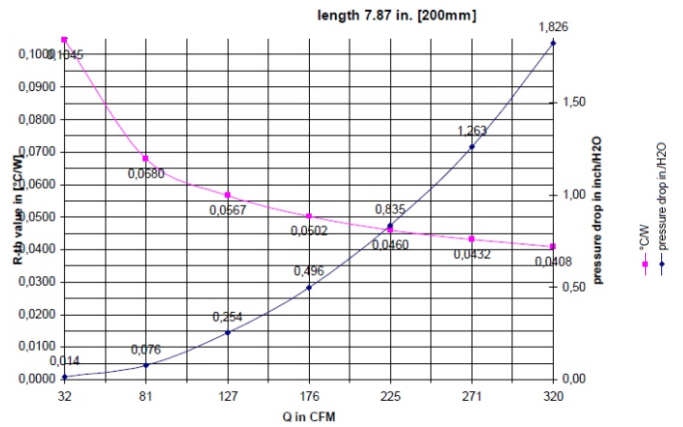
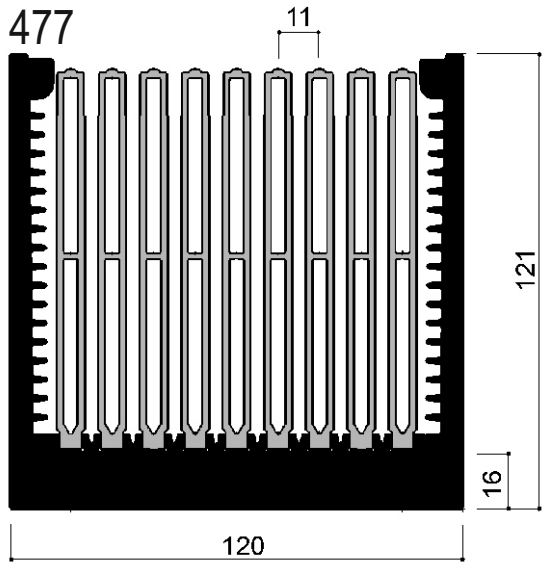

Resistenza termica (KW) in ventilazione forzata

Lg. (mm)	100	200	300
R _n a 5m/s	0,11	0,068	0,052

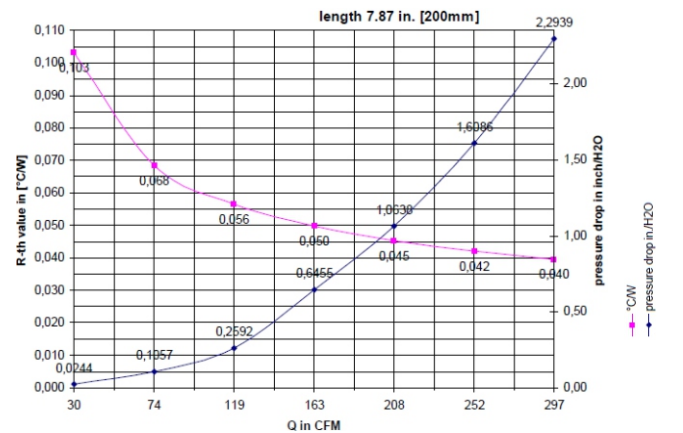
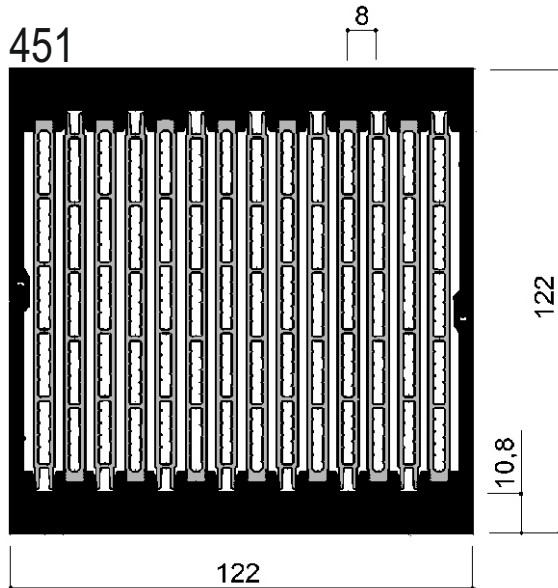

Resistenza termica (KW) in ventilazione forzata

Lg. (mm)	100	200	300
R _n a 5m/s	0,082	0,068	0,052

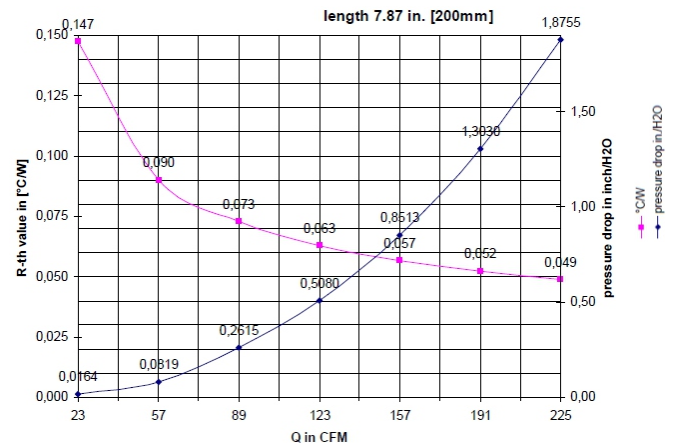
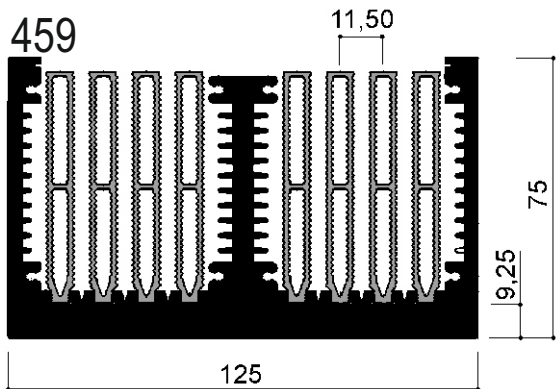

DISSIPATORI AD ALTO RENDIMENTO



DISEGNI META' DEL VERO (1:2)- SCALE 1:2

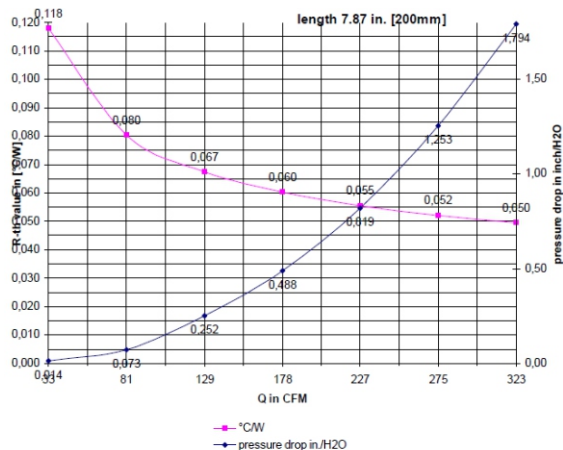
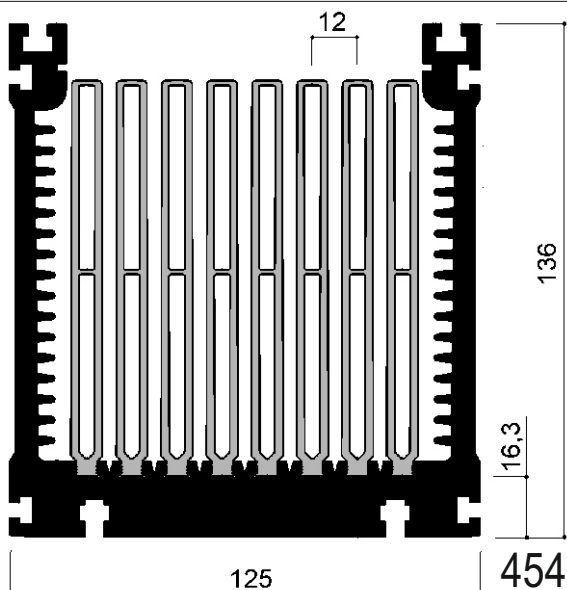

Resistenza termica (KW) in ventilazione forzata

Lg. (mm)	100	200	300
R _{th} a 5m/s	0,13	0,08	0,06

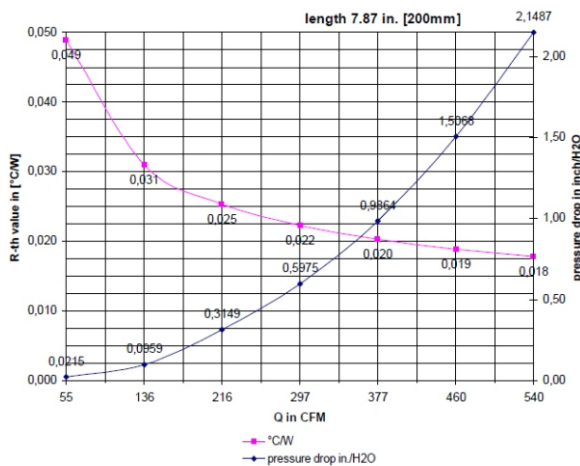
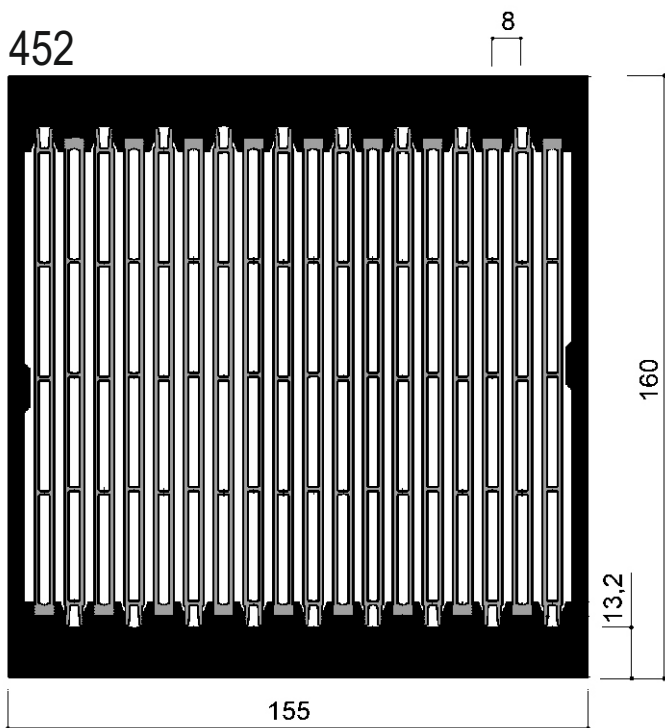

Resistenza termica (KW) in ventilazione forzata

Lg. (mm)	100	200	300
R _{th} a 5m/s	0,046	0,031	0,025

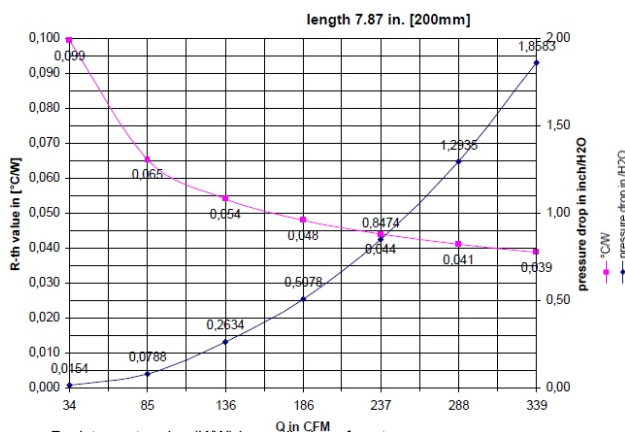
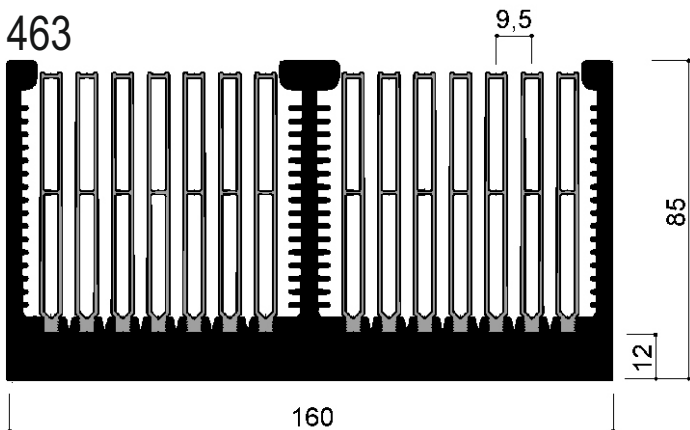

Resistenza termica (KW) in ventilazione forzata

Lg. (mm)	100	200	300
R _{th} a 5m/s	0,082	0,065	0,05

Via Newton, n. 12

20016 Pero (Milano - Italy)

Tel. +39 02 3535955 r.a. Fax. +39 02 3539929

E-Mail: info@omar-alluminio.it

Cataloghi Online: www.omar-alluminio.it

www.omar-alluminio.com

PROFILATI ALLUMINIO A DISEGNO / STANDARD / SPECIALI / E PER:

ELETTRONICA / LED / FOTOVOLTAICO / AUTOMAZIONE ROBOTICA / PNEUMATICA / AUTOMOTIVE



DISSIPATORI AD ALTO RENDIMENTO



DISEGNI META' DEL VERO (1:2)- SCALE 1:2

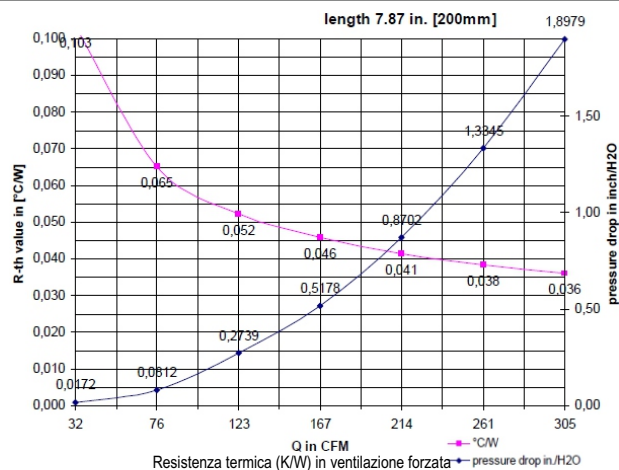
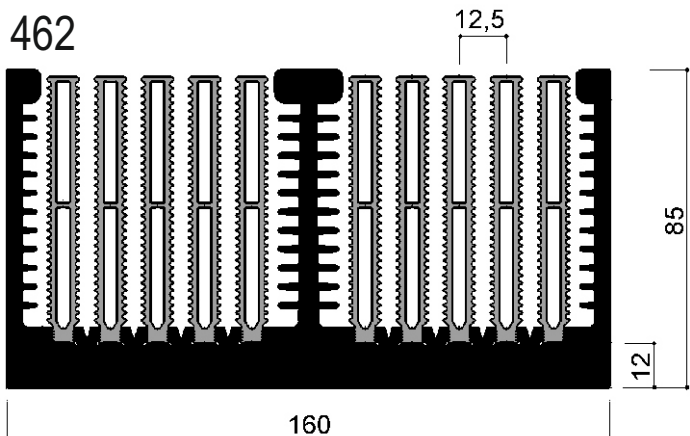

Lg. (mm)	100	200	300
Rth a 5m/s	0,082	0,065	0,05

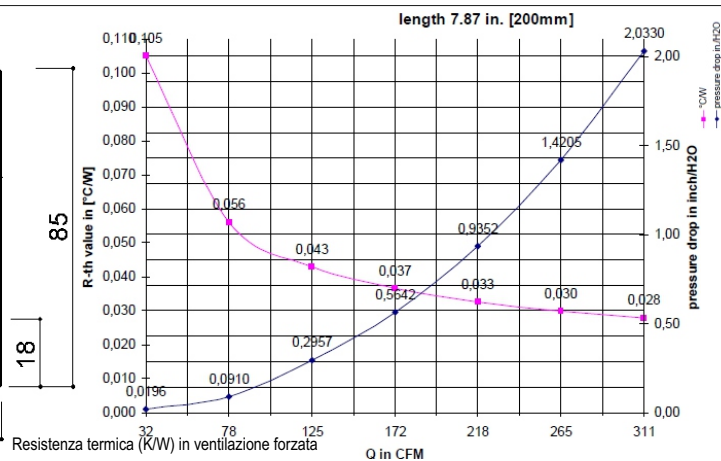
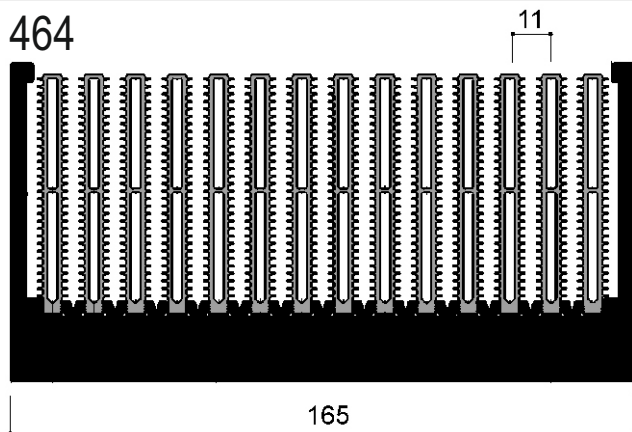

Lg. (mm)	100	200	300
Rth a 5m/s	0,077	0,056	0,048



FOTO DI ESEMPIO: TAGLIO A MISURA DISSIPATORI AD ALTO RENDIMENTO DI GROSSE DIMENSIONI

Via Newton, n.12
20016 Pero (Milano - Italy)
Tel. +39 02 3535955 r.a. Fax. +39 02 3539929
E. Mail: info@omar-alluminio.it

Cataloghi Online: www.omar-alluminio.it
www.omar-alluminio.com
PROFILATI ALLUMINIO A DISEGNO / STANDARD / SPECIALI / E PER:
ELETTRONICA / LED / FOTOVOLTAICO / AUTOMAZIONE ROBOTICA / PNEUMATICA / AUTOMOTIVE

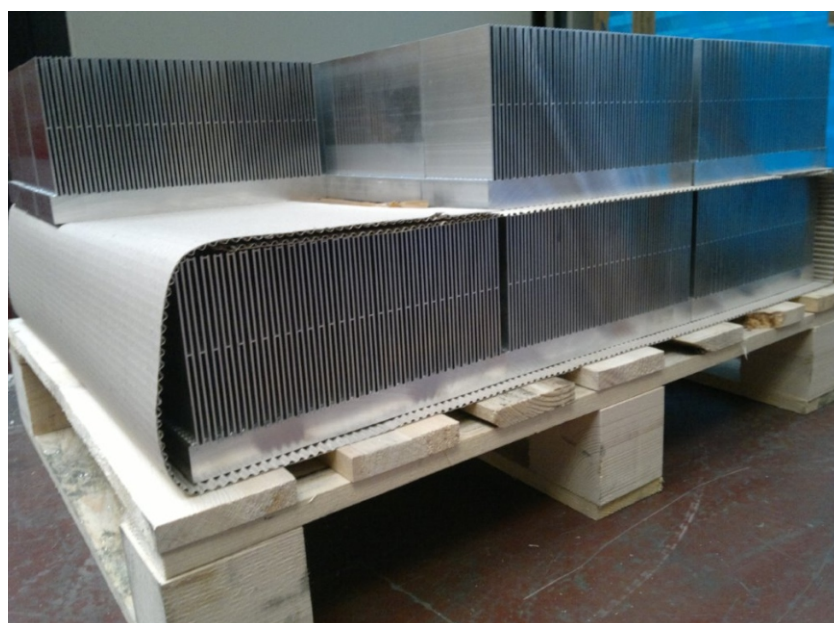

DISSIPATORI AD ALTO RENDIMENTO

DISEGNI META' DEL VERO (1:2)- SCALE 1:2

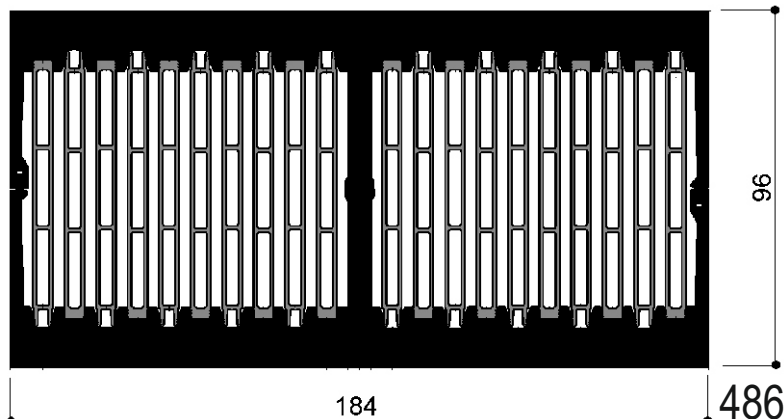

length 11.81 in. [300mm]

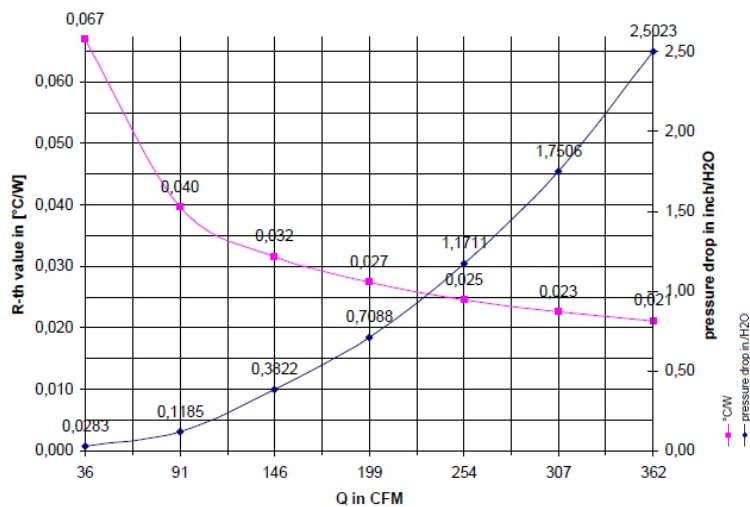

Resistenza termica (K/W) in ventilazione forzata

Lg. (mm)	100	200	300
R _{th} 5m/s	0,065	0,05	0,04



FOTO DI ESEMPIO: SI ESEGUONO OPERAZIONI DI TRANCIATURA SU PROFILI ESTRUSI IN ALLUMINIO



length 7.87 in. [200mm]

Resistenza termica (K/W) in ventilazione forzata

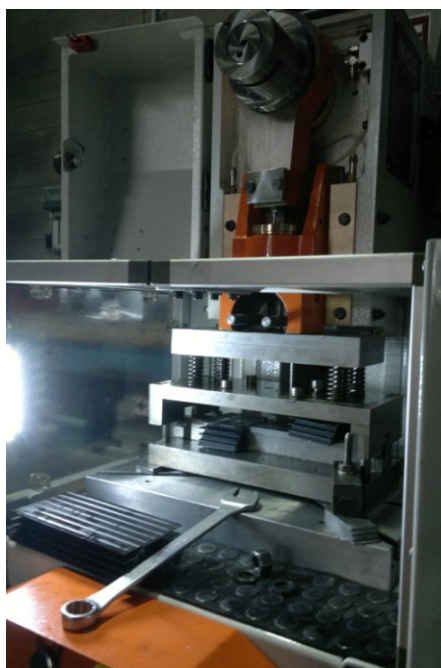
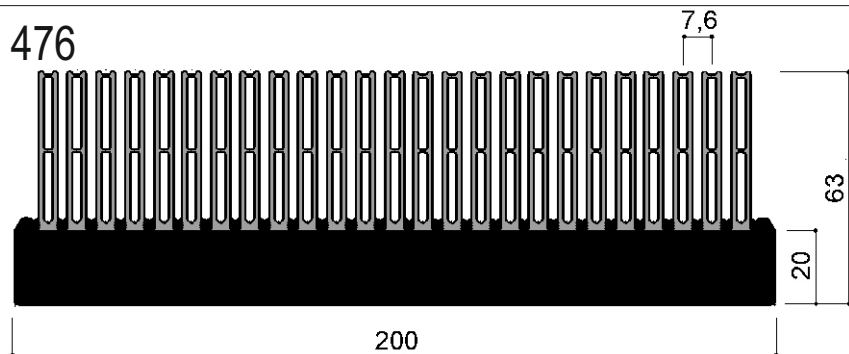
Lg. (mm)	100	200	300
R _{th} a 11 m/s	0,0617	0,042	0,034

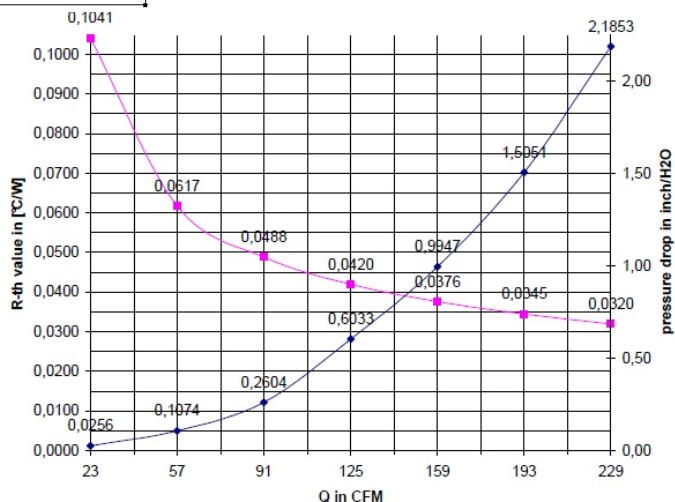
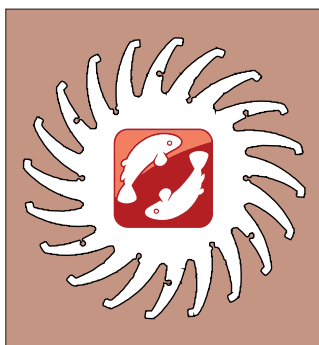

Via Newton, n.12
20016 Pero (Milano - Italy)
Tel. +39 02 3535955 r.a. Fax. +39 02 3539929
E-Mail: info@omar-alluminio.it

Cataloghi Online: www.omar-alluminio.it
www.omar-alluminio.com

PROFILATI ALLUMINIO A DISEGNO / STANDARD / SPECIALI / E PER:
ELETTRONICA / LED / FOTOVOLTAICO / AUTOMAZIONE ROBOTICA / PNEUMATICA / AUTOMOTIVE



DISSIPATORI AD ALTO RENDIMENTO



DISEGNI META' DEL VERO (1:2)- SCALE 1:2

475

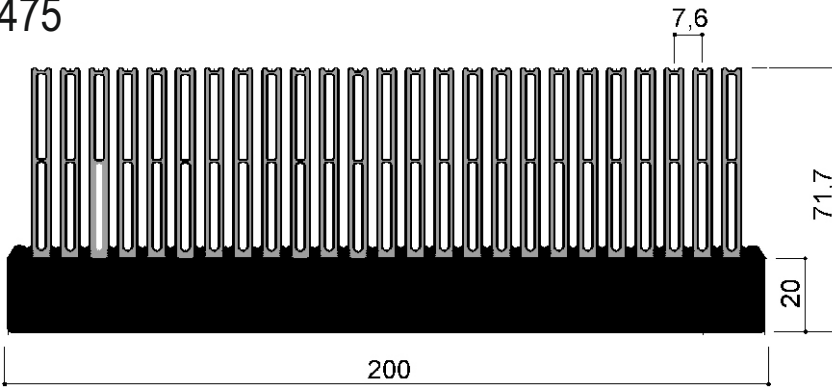

length 7.87 in. [200mm]

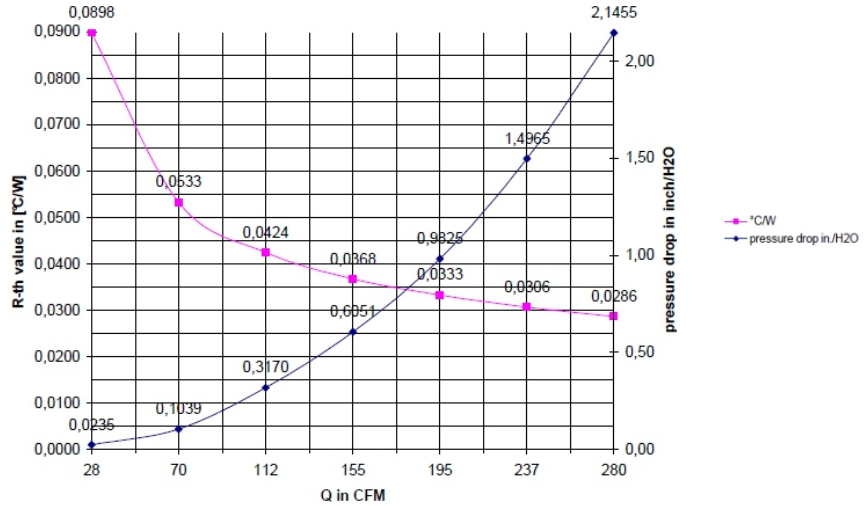

455

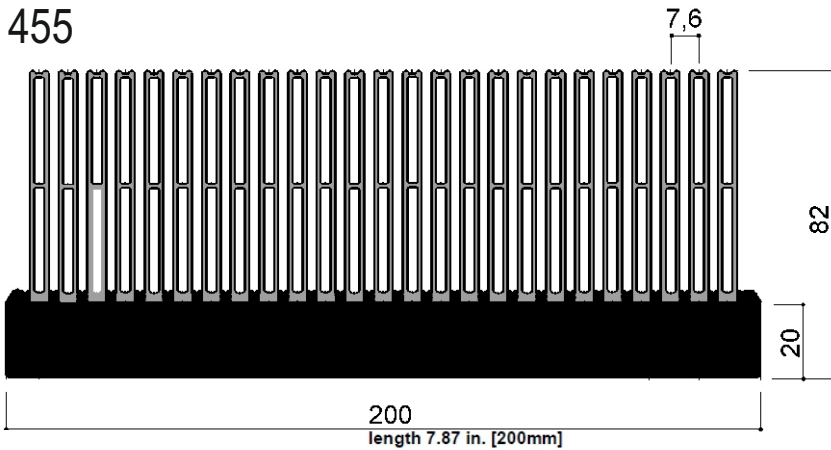

length 7.87 in. [200mm]



FOTO DI ESEMPIO: SI ESEGUONO LAVORAZIONI MECCANICHE SU PROFILI ESTRUSI IN ALLUMINIO

Cataloghi Online: www.omar-alluminio.it
www.omar-alluminio.com

PROFILATI ALLUMINIO A DISEGNO / STANDARD / SPECIALI / E PER:
ELETTRONICA / LED / FOTOVOLTAICO / AUTOMAZIONE ROBOTICA / PNEUMATICA / AUTOMOTIVE

Via Newton, n. 12
20016 Pero (Milano - Italy)
Tel. +39 02 3535955 r.a. Fax. +39 02 3539929
E. Mail: info@omar-alluminio.it

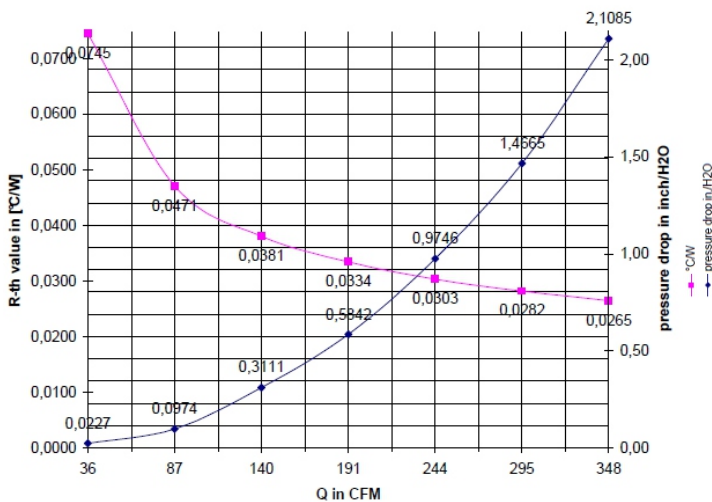
OMAR s.r.l.
PROFILATI ALLUMINIO
ALTA TECNOLOGIA

DISSIPATORI AD ALTO RENDIMENTO



DISEGNI META' DEL VERO (1:2)- SCALE 1:2

465

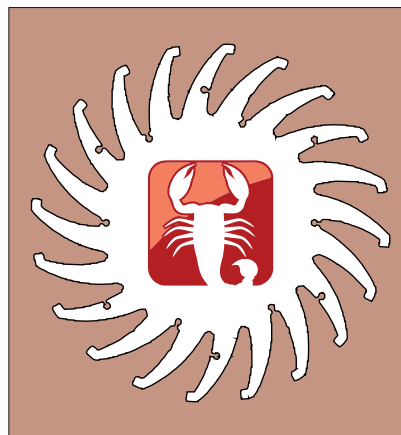
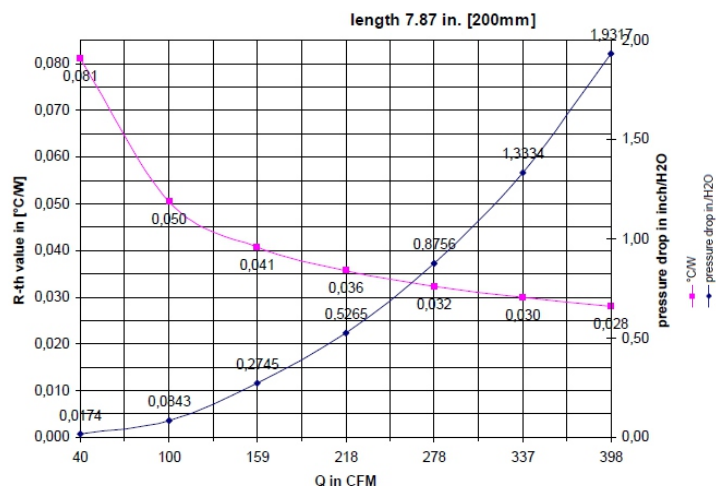
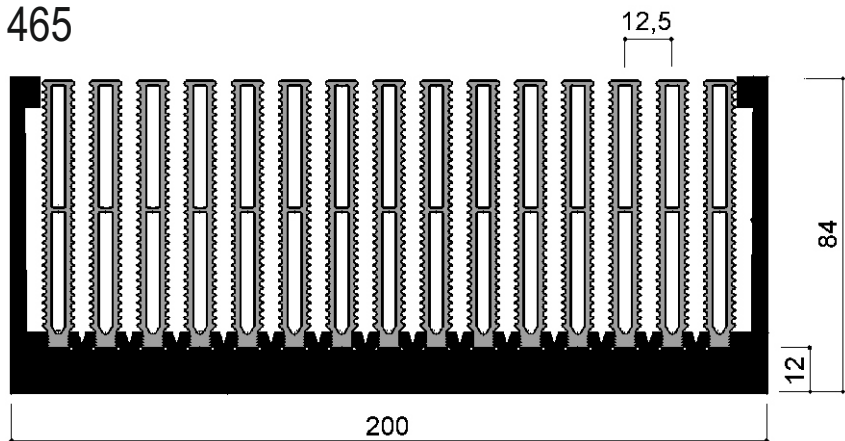

460

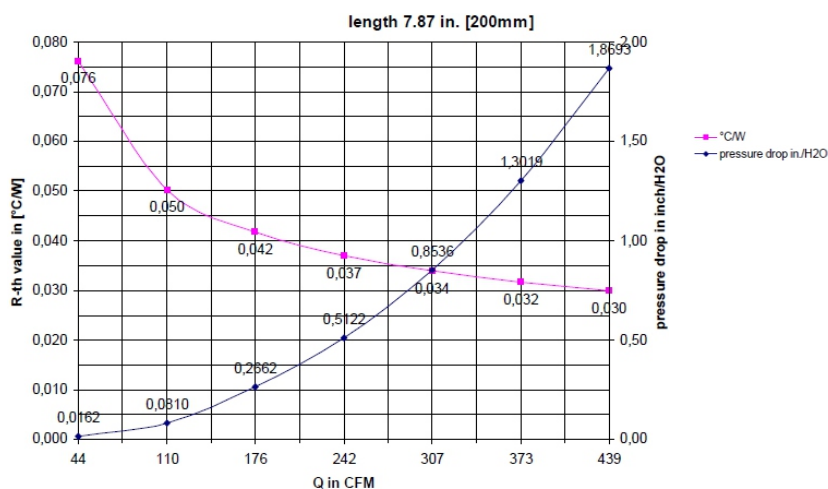
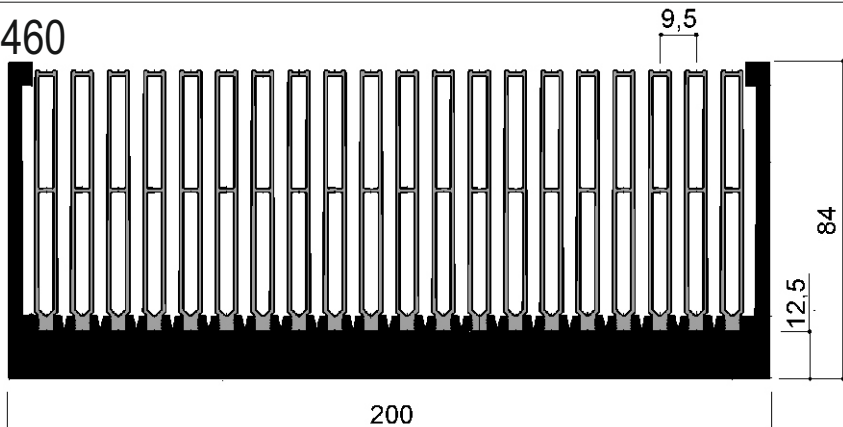

Cataloghi Online: www.omar-alluminio.it
www.omar-alluminio.com

Via Newton, n.12
 20016 Pero (Milano - Italy)
 Tel. +39 02 3535955 r.a. Fax. +39 02 3539929
 E-Mail: info@omar-alluminio.it

PROFILATI ALLUMINIO A DISEGNO / STANDARD / SPECIALI / E PER:
 ELETTRONICA / LED / FOTOVOLTAICO / AUTOMAZIONE ROBOTICA / PNEUMATICA / AUTOMOTIVE



DISSIPATORI AD ALTO RENDIMENTO

DISEGNI META' DEL VERO (1:2)- SCALE 1:2



Via Newton, n.12
20016 Pero (Milano - Italy)
Tel. +39 02 3535955 r.a. Fax. +39 02 3539929
E. Mail: info@omar-alluminio.it

Cataloghi Online: www.omar-alluminio.it
www.omar-alluminio.com
PROFILATI ALLUMINIO A DISEGNO / STANDARD / SPECIALI / E PER:
ELETTRONICA / LED / FOTOVOLTAICO / AUTOMAZIONE ROBOTICA / PNEUMATICA / AUTOMOTIVE

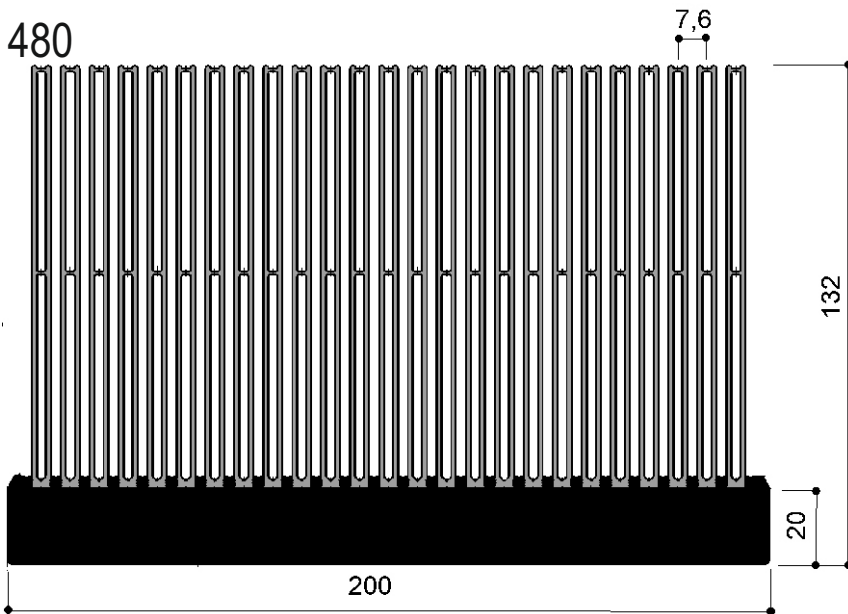

Resistenza termica (K/W) in ventilazione forzata

Lg. (mm)	200	300	400
Rth 5m/s	0,0414	0,0254	0,0193

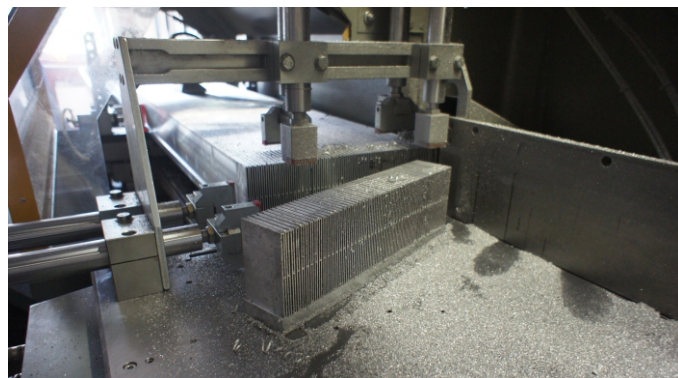
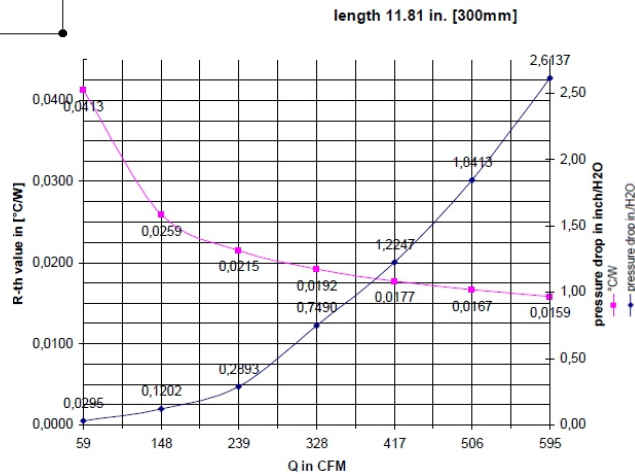

N.3 LINEE DI TAGLIO:SI ESEGUONO TAGLI SU PROFILI IN ALLUMINIO ANCHE DI GRANDI DIMENSIONI



DISSIPATORI AD ALTO RENDIMENTO

DISEGNI META' DEL VERO (1:2)- SCALE 1:2

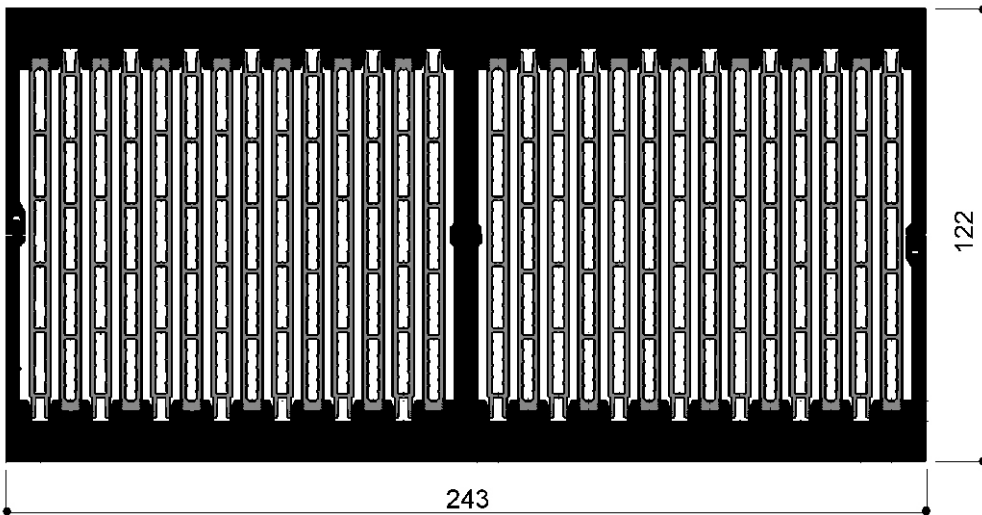

487

Resistenza termica (K/W) in ventilazione forzata

Lg. (mm)	100	200	300
Rth5m/s	0,041	0,034	0,026

length 11.81 in. [300mm]

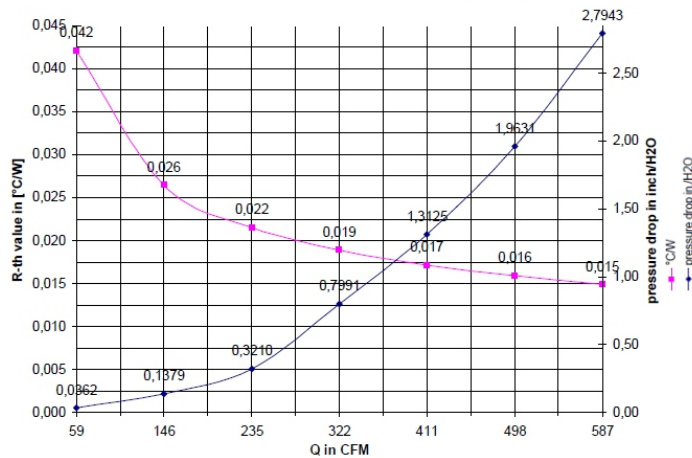

484

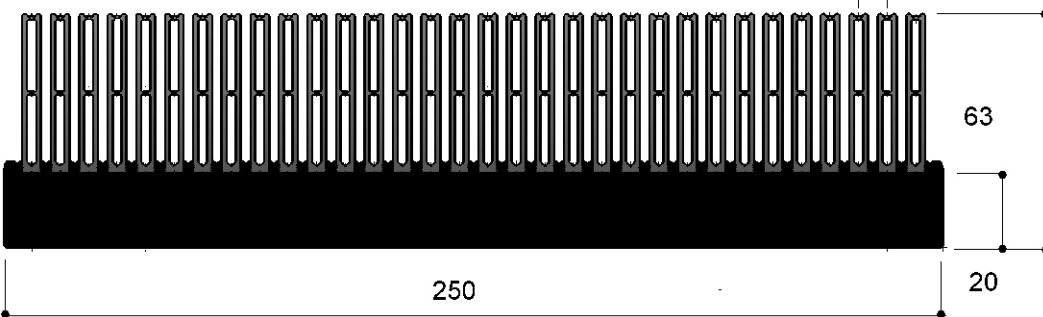

Resistenza termica (K/W) in ventilazione forzata

Lg. (mm)	100	200	300
Rth 11m/s	0,0480	0,0328	0,0265

length 11.81 in. [300mm]

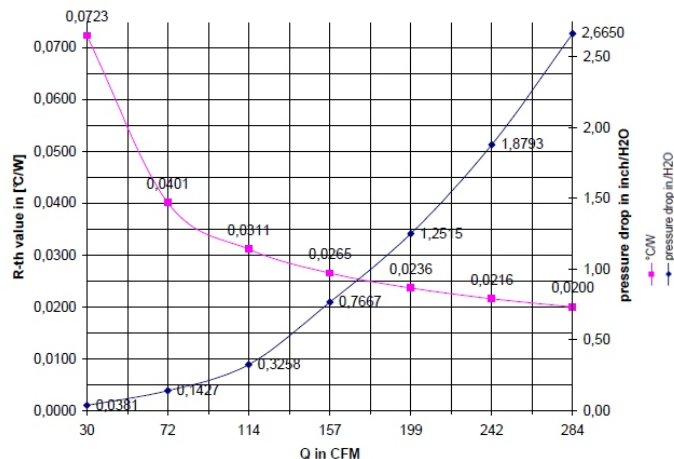

Cataloghi Online: www.omar-alluminio.it
www.omar-alluminio.com

PROFILATI ALLUMINIO A DISEGNO / STANDARD / SPECIALI / E PER:
ELETTRONICA / LED / FOTOVOLTAICO / AUTOMAZIONE ROBOTICA / PNEUMATICA / AUTOMOTIVE



Via Newton, n.12

20016 Pero (Milano - Italy)

Tel. +39 02 3535955 r.a. Fax. +39 02 3539929

E-Mail: info@omar-alluminio.it

DISSIPATORI AD ALTO RENDIMENTO

DISEGNI META' DEL VERO (1:2)- SCALE 1:2



Via Newton, n.12
20016 Pero (Milano - Italy)
Tel. +39 02 3535955 r.a. Fax. +39 02 3539929
E.Mai: info@omar-alluminio.it

Cataloghi Online: www.omar-alluminio.it
www.omar-alluminio.com
PROFILATI ALLUMINIO A DISEGNO / STANDARD / SPECIALI / E PER:
ELETTRONICA / LED / FOTOVOLTAICO / AUTOMAZIONE ROBOTICA / PNEUMATICA / AUTOMOTIVE

483

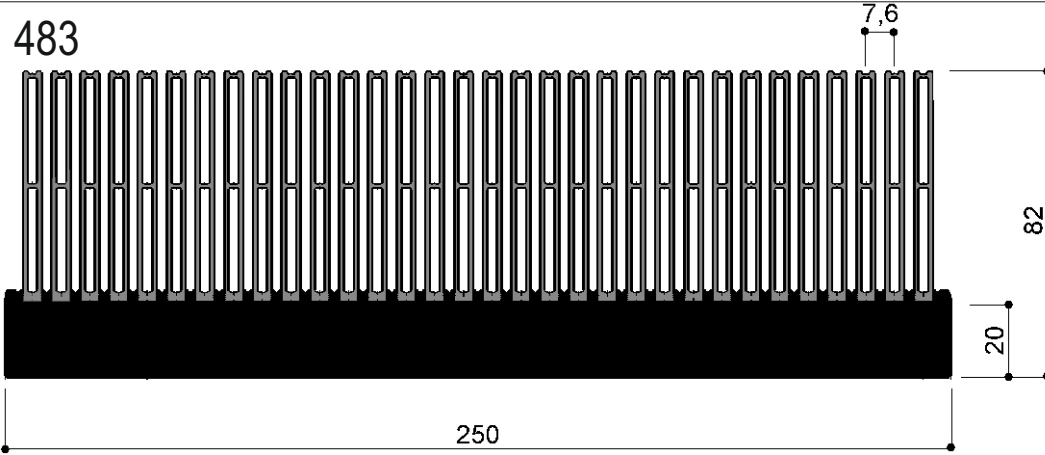

Resistenza termica (K/W) in ventilazione forzata

Lg. (mm)	100	200	300
R _{th} 11m/s	0,0400	0,0261	0,0207

length 11.81 in. [300mm]

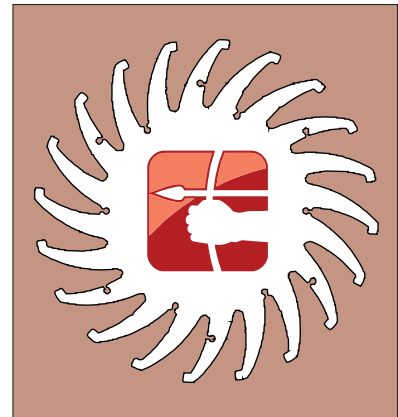
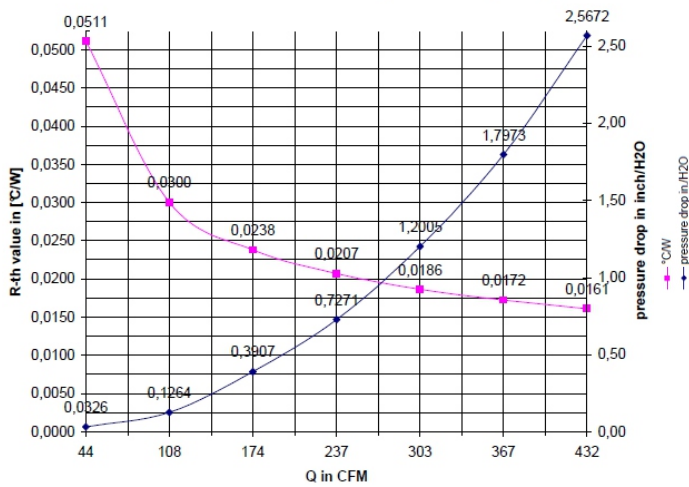

489

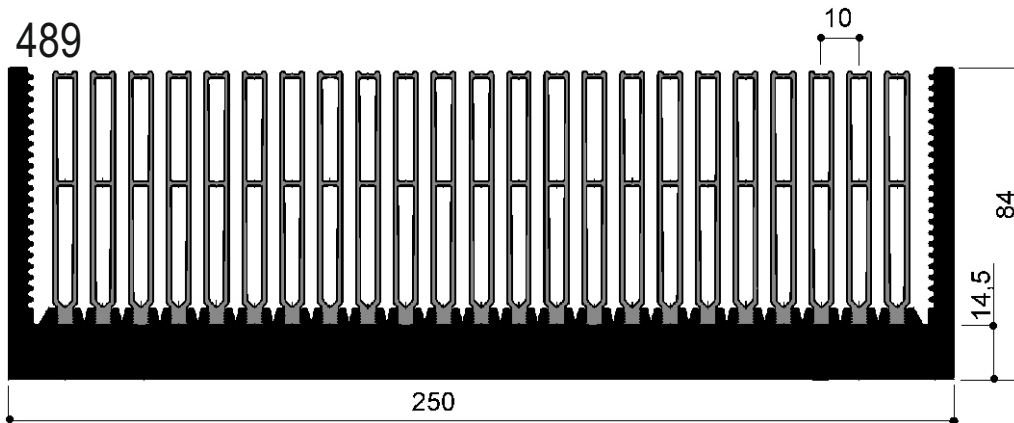

Resistenza termica (K/W) in ventilazione forzata

Lg. (mm)	100	200	300	400
R _{th} 5/s	0,0663	0,0438	0,0349	0,0300

length 15.74 in. [400mm]

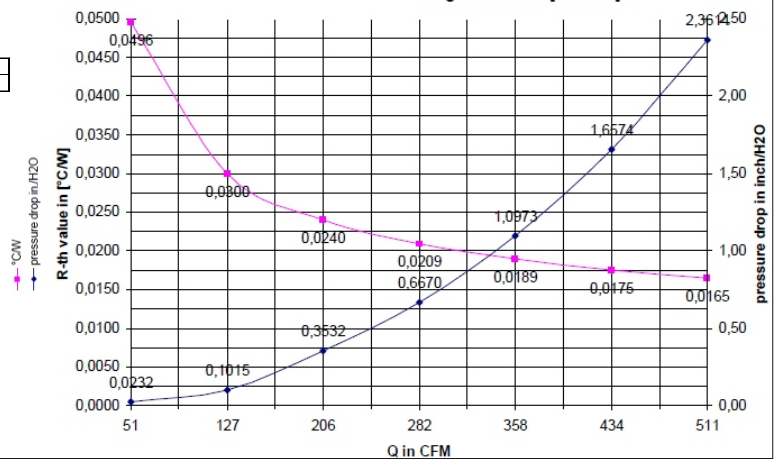

DISSIPATORI AD ALTO RENDIMENTO



DISEGNI META' DEL VERO (1:2)- SCALE 1:2

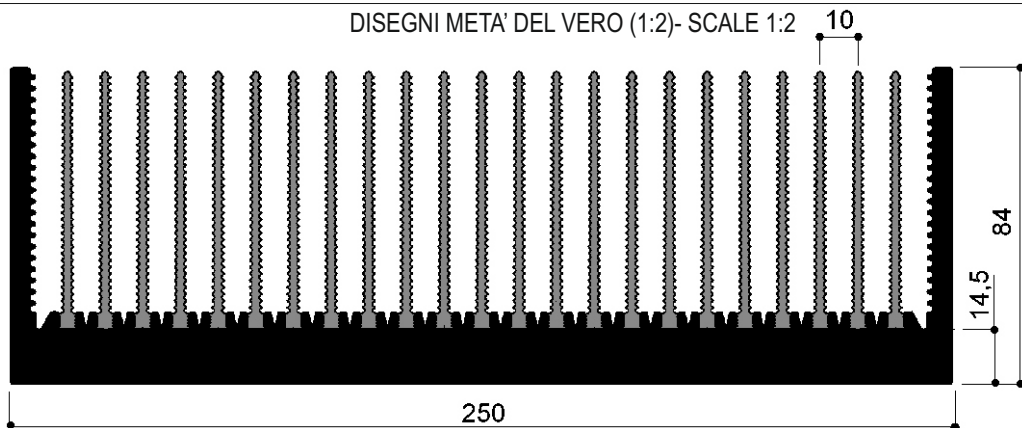

492

Resistenza termica (K/W) in ventilazione forzata

Lg. (mm)	100	200	300	400
Rth5/s	0,0963	0,0644	0,0516	0,0437

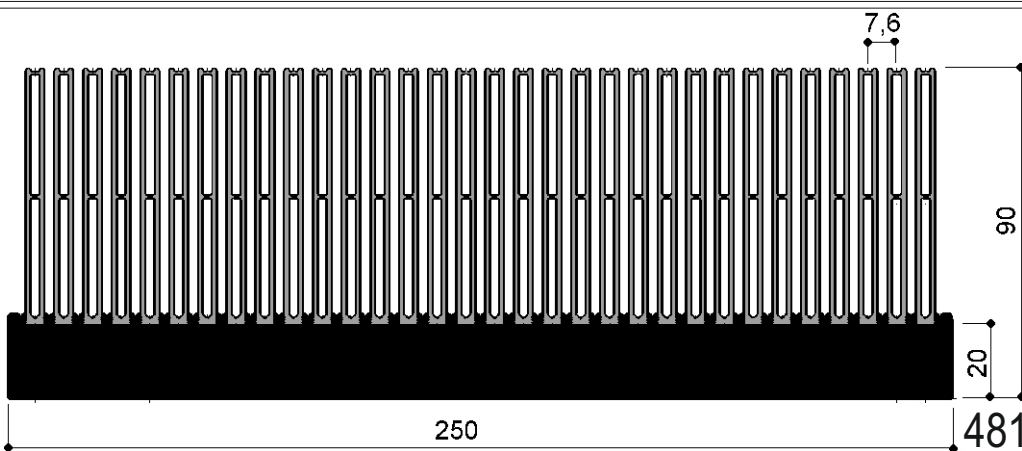
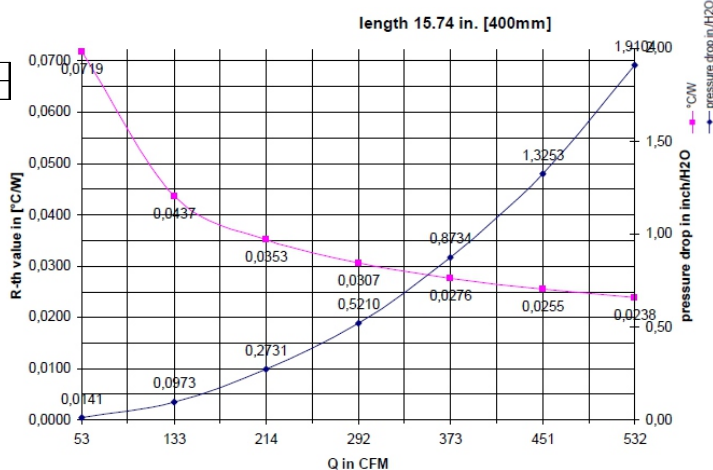

Resistenza termica (K/W) in ventilazione forzata

Lg. (mm)	100	200	300
Rth11m/s	0,0370	0,0239	0,0188

length 11.81 in. [300mm]



FOTO DI ESEMPIO: DISSIPATORI "FLOWER" A STOCK IN PRONTA CONSEGNA

Via Newton, n.12
20016 Pero (Milano - Italy)
Tel. +39 02 3535955 r.a. Fax. +39 02 3539929
E-Mail: info@omar-alluminio.it

Cataloghi Online: www.omar-alluminio.it
www.omar-alluminio.com

PROFILATI ALLUMINIO

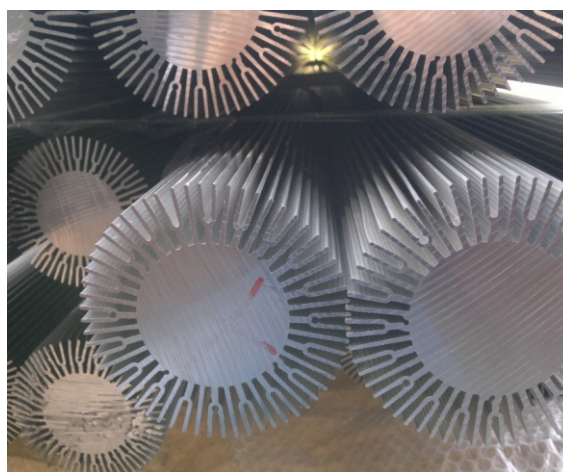
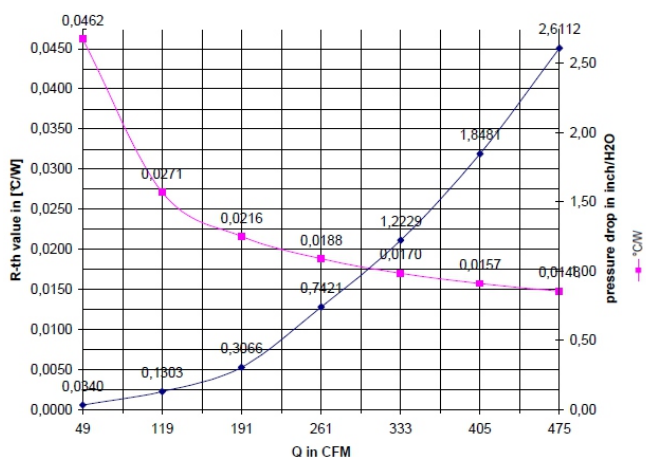
A DISEGNO / STANDARD / SPECIALI E LORO DERIVATI



DISSIPATORI AD ALTO RENDIMENTO

DISEGNI META' DEL VERO (1:2)- SCALE 1:2

Via Newton, n. 12
20016 Pero (Milano - Italy)
Tel. +39 02 3535955 r.a. Fax. +39 02 3539929
E. Mail: info@omar-alluminio.it

Cataloghi Online: www.omar-alluminio.it
www.omar-alluminio.com

PROFILATI ALLUMINIO A DISEGNO / STANDARD / SPECIALI / E PER:
ELETTRONICA / LED / FOTOVOLTAICO / AUTOMAZIONE ROBOTICA / PNEUMATICA / AUTOMOTIVE

482

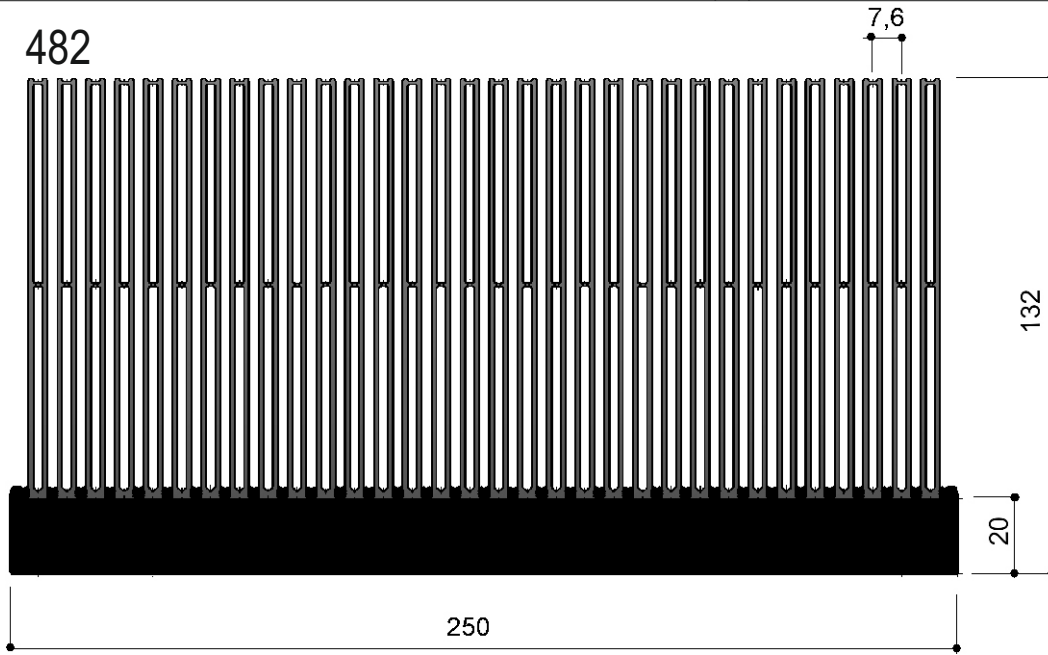

Resistenza termica (K/W) in ventilazione forzata

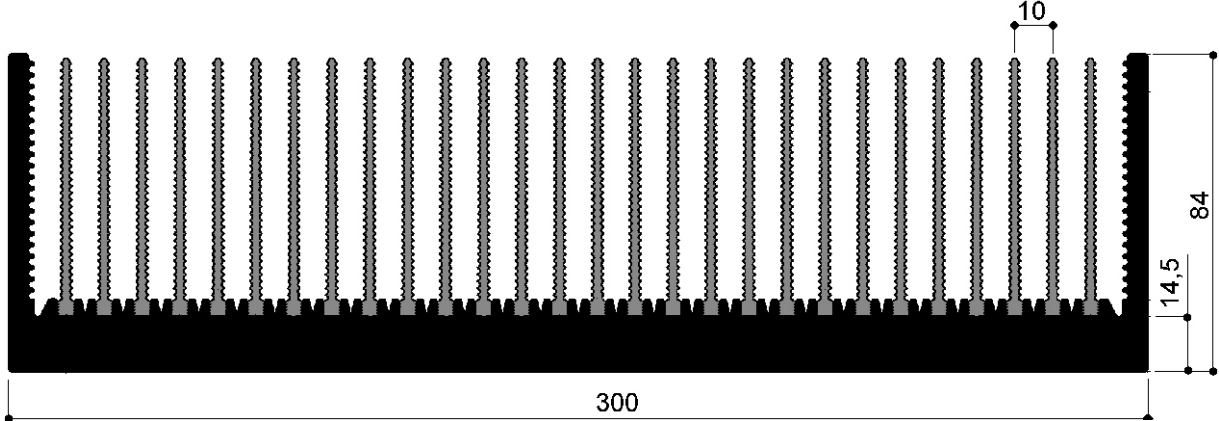
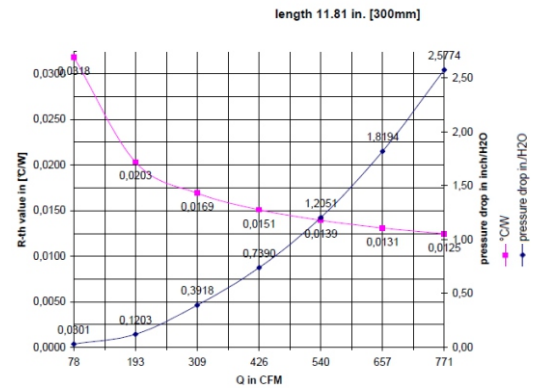

493

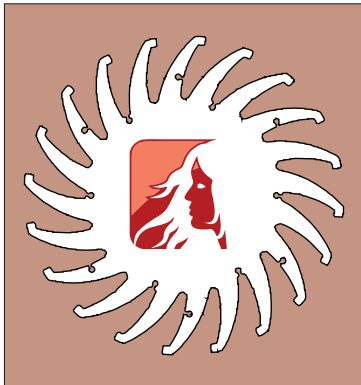
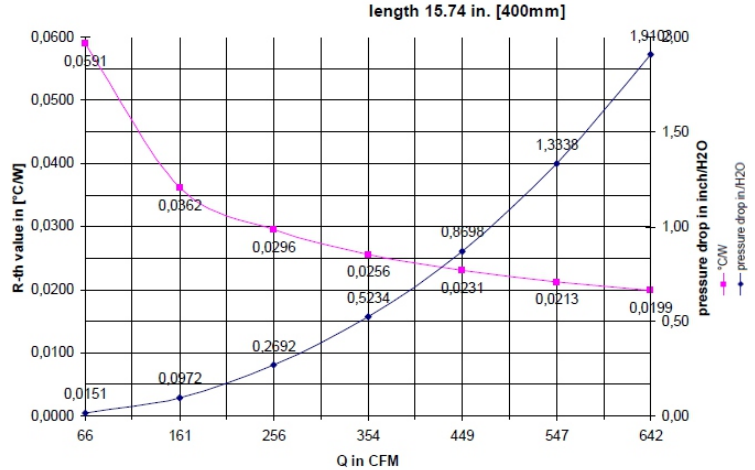

DISSIPATORI AD ALTO RENDIMENTO



DISEGNI FUORI SCALA

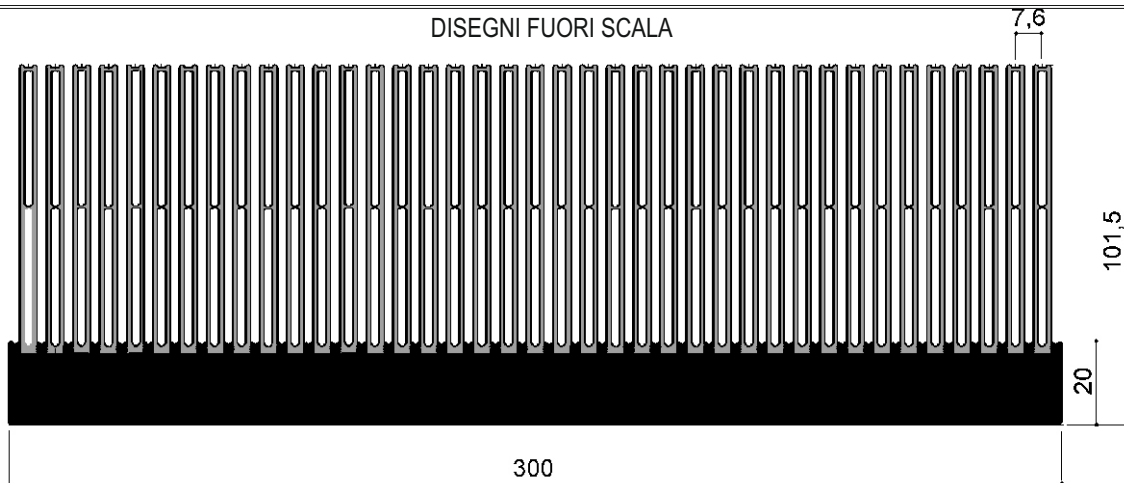

456

300

length 7.87 in. [200mm]

Resistenza termica (KW) in ventilazione forzata

Lg. (mm)	100	200	300	400
R _{th} a 11 m/s	0,00284	0,0181	0,0141	0,119

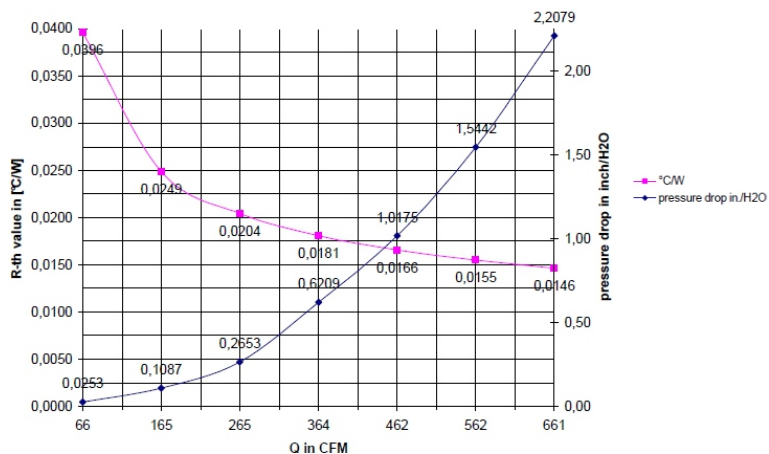

DISEGNI FUORI SCALA

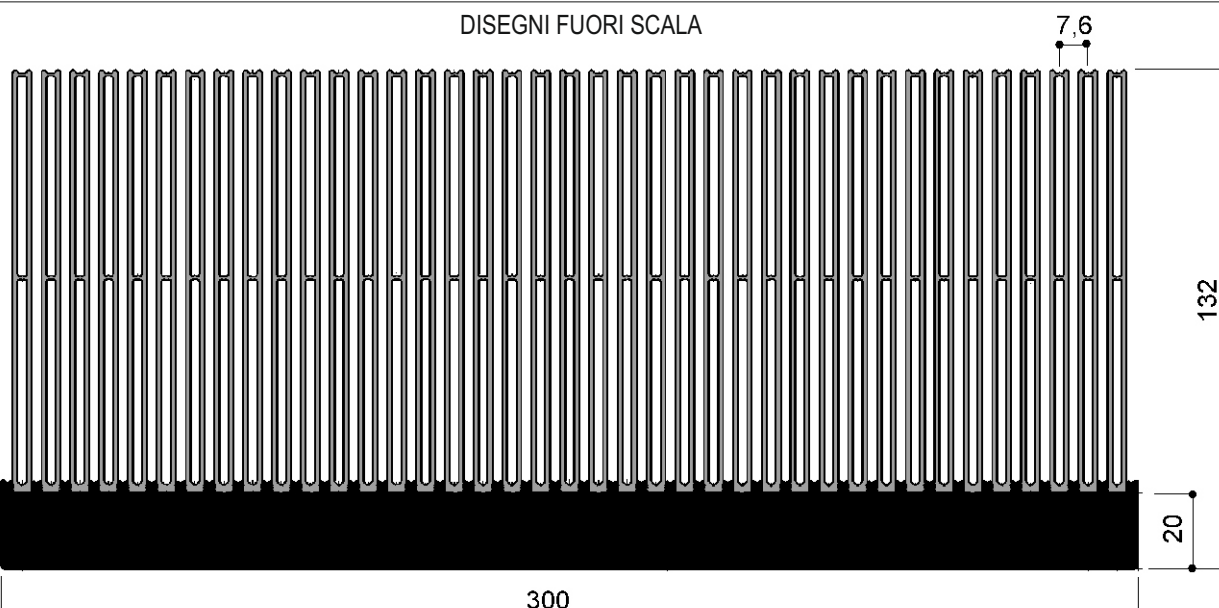

479

300

length 19.68 in. [500mm]

Resistenza termica (KW) in ventilazione forzata

Lg. (mm)	200	300	400
R _{th} 5 m/s	0,0163	0,0124	0,0103

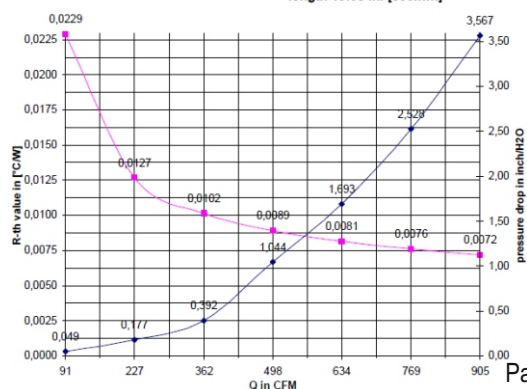

DISSIPATORI AD ALTO RENDIMENTO

DISEGNI FUORI SCALA



Via Newton, n.12
20016 Pero (Milano - Italy)
Tel. +39 02 3535955 r.a. Fax. +39 02 3539929
E.Mail: info@omar-alluminio.it

Cataloghi Online: www.omar-alluminio.it
www.omar-alluminio.com

PROFILATI ALLUMINIO A DISEGNO / STANDARD / SPECIALI / E PER:
ELETTRONICA / LED / FOTVOLTAICO / AUTOMAZIONE ROBOTICA / PNEUMATICA / AUTOMOTIVE



FOTO DI ESEMPIO: PROFILI IN ALLUMINIO CARCASSE DI MOTORI ELETTRICI TAGLIATI A MISURA STOCCATI SU PALLETT, IN PRONTA CONSEGNA

DISSIPATORI AD ALTO RENDIMENTO



DISEGNI FUORI SCALA

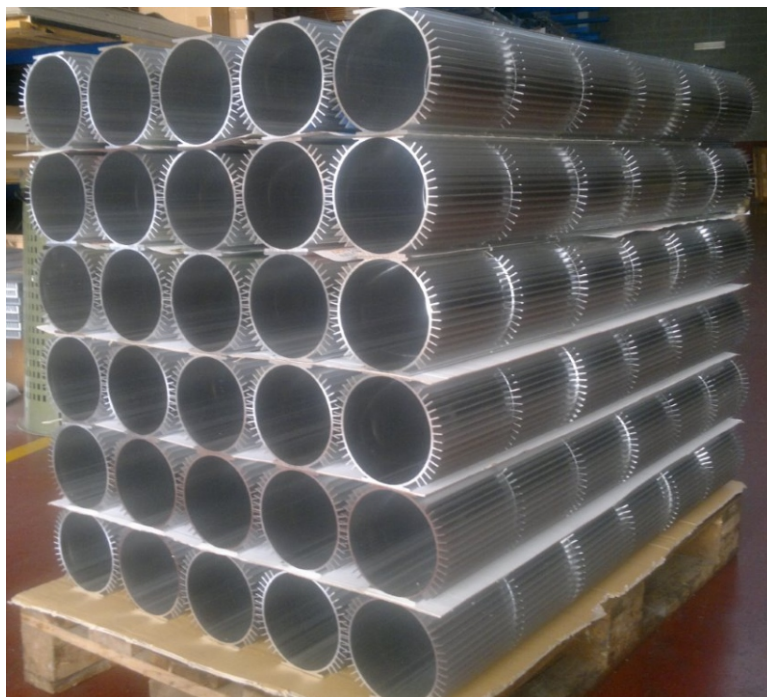
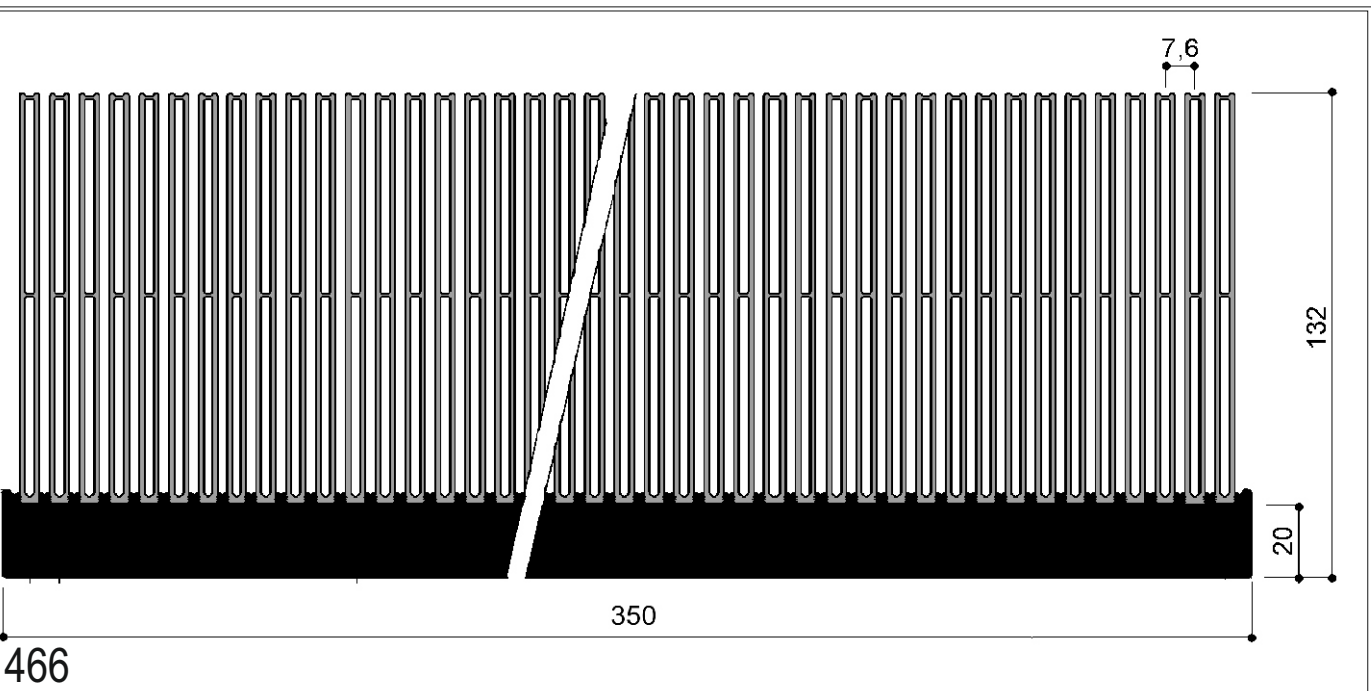
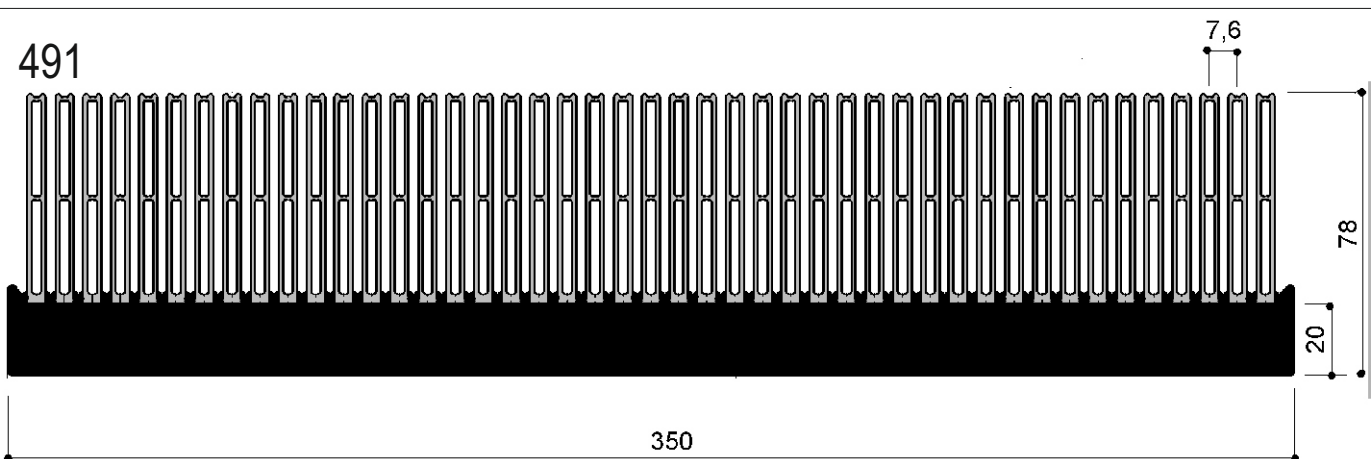
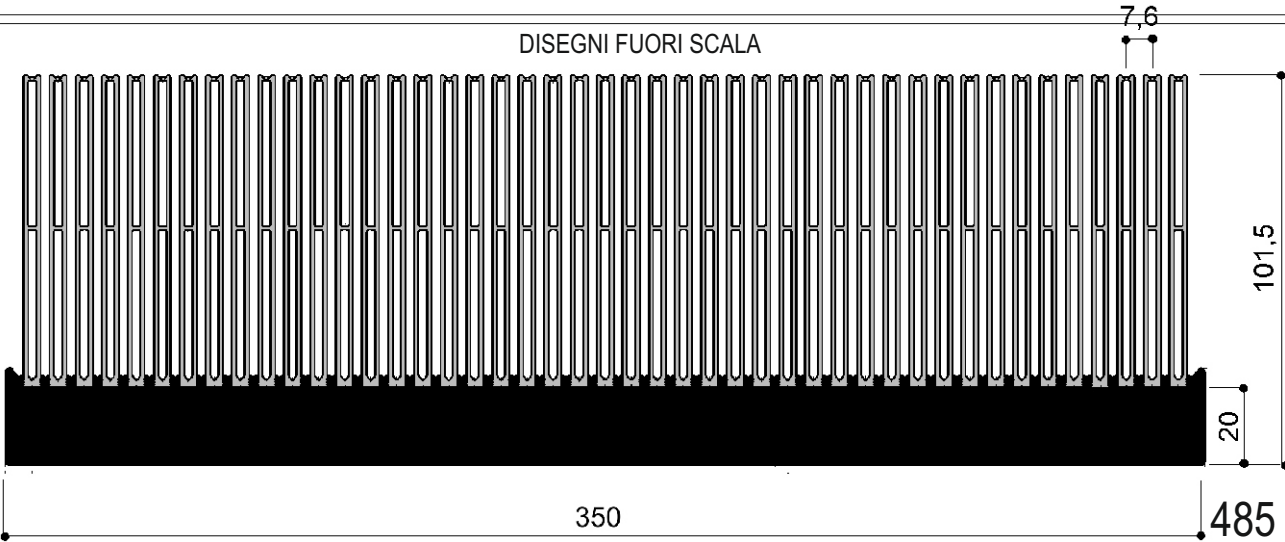

Resistenza termica (KW) in ventilazione forzata

Lg. (mm)	200	300	400
Rth 11 m/s	0,0157	0,0122	0,0103

length 15.75 in. [400mm]



FOTO DI ESEMPIO: DISSIPATORI A VENTILAZIONE FORZATA PER 6 SCHEDE LED

DISEGNI FUORI SCALA

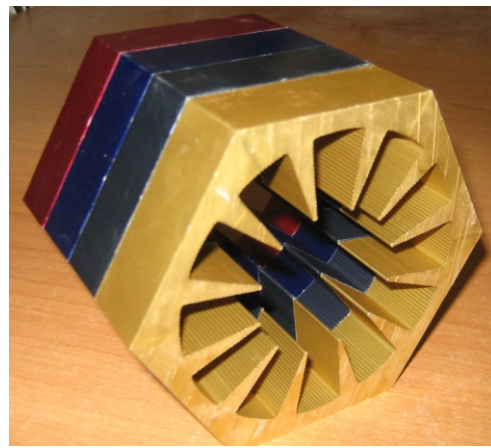
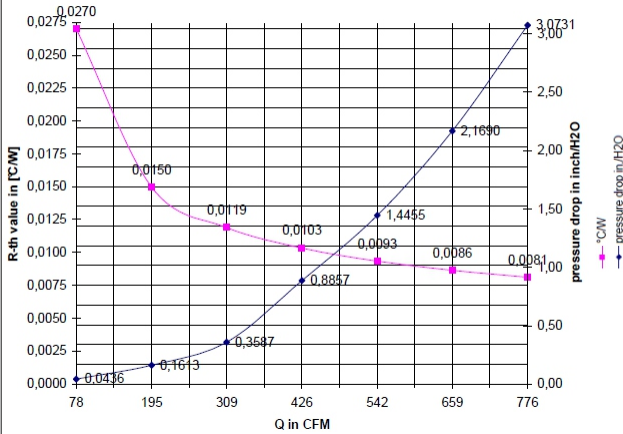
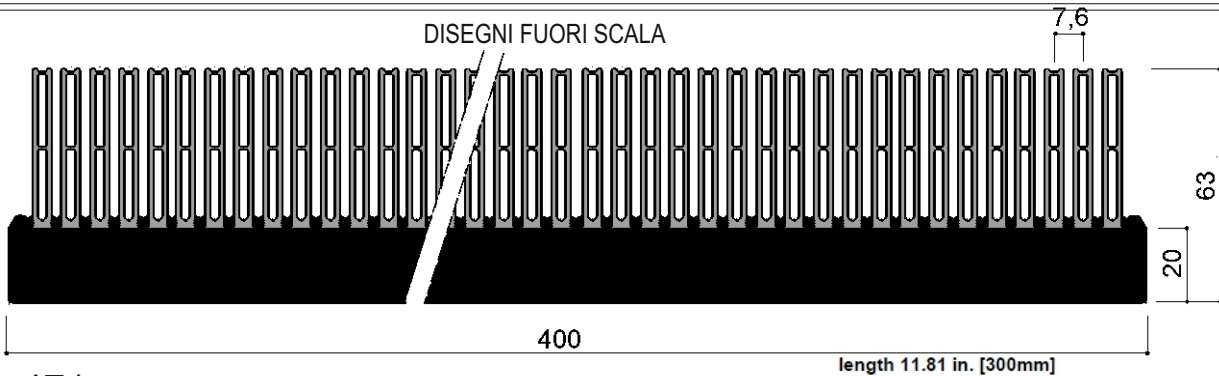

471

length 11.81 in. [300mm]

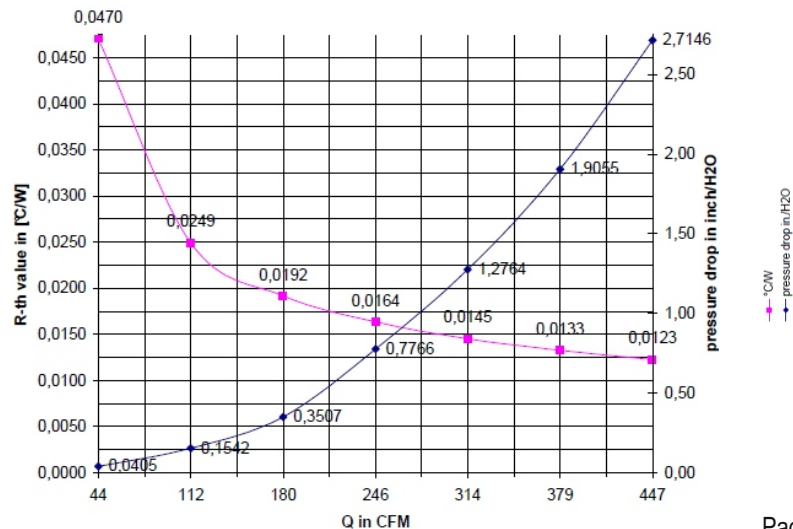

I valori espressi dalle curve sono puramente indicativi
 AGGIORNAMENTO CONTINUO - ED. DEL 02-2017
 -RIPRODUZIONE VIETATA-

Via Newton, n.12
 20016 Pero (Milano - Italy)
 Tel. +39 02 3535955 r.a. Fax. +39 02 3539929
 E-Mail: info@omar-alluminio.it

Cataloghi Online: www.omar-alluminio.it
www.omar-alluminio.com

PROFILATI ALLUMINIO A DISEGNO / STANDARD / SPECIALI / E PER:
 ELETTRONICA / LED / FOTOVOLTAICO / AUTOMAZIONE ROBOTICA / PNEUMATICA / AUTOMOTIVE



DISSIPATORI AD ALTO RENDIMENTO

DISEGNI META' DEL VERO (1:2)- SCALE 1:2

Via Newton, n. 12
20016 Pero (Milano - Italy)
Tel. +39 02 3535955 r.a. Fax. +39 02 3539929
E. Mail: info@omar-alluminio.it

Cataloghi Online: www.omar-alluminio.it
www.omar-alluminio.com
PROFILATI ALLUMINIO A DISEGNO / STANDARD / SPECIALI / E PER:
ELETTRONICA / LED / FOTOVOLTAICO / AUTOMAZIONE ROBOTICA / PNEUMATICA / AUTOMOTIVE

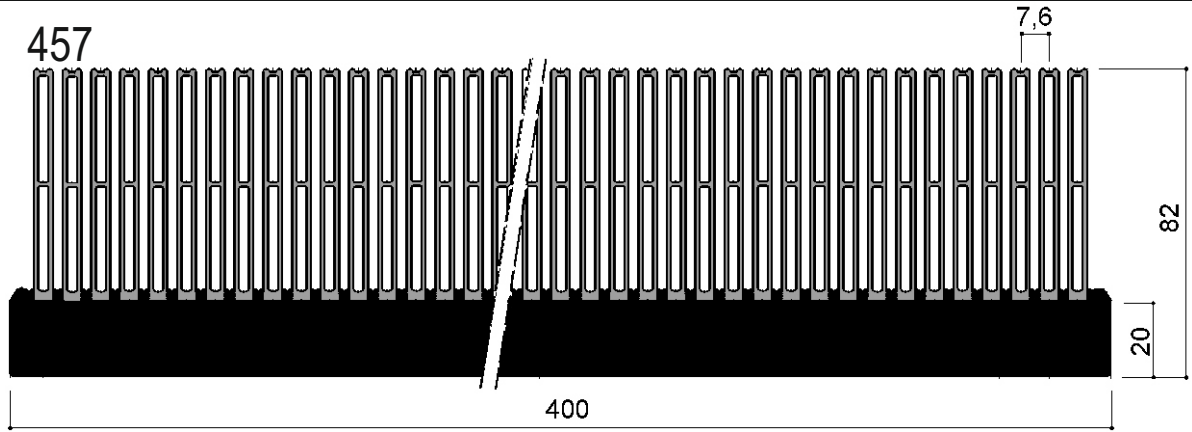

Resistenza termica (KW) in ventilazione forzata

Lg. (mm)	200	300	400	500
R _{th} a 11m/s	0,00161	0,0128	0,0109	0,0097

length 11.81 in. [300mm]



FOTO DI ESEMPIO: TAGLIO A MISURA DI DISSIPATORI "FLOWER" ANCHE DI GROSSE DIMENSIONI



Resistenza termica (KW) in ventilazione forzata

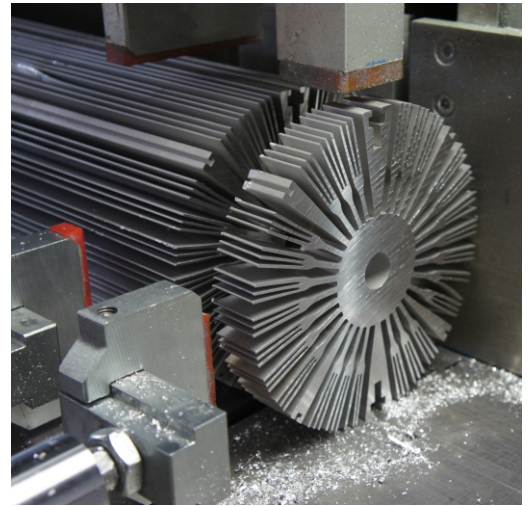
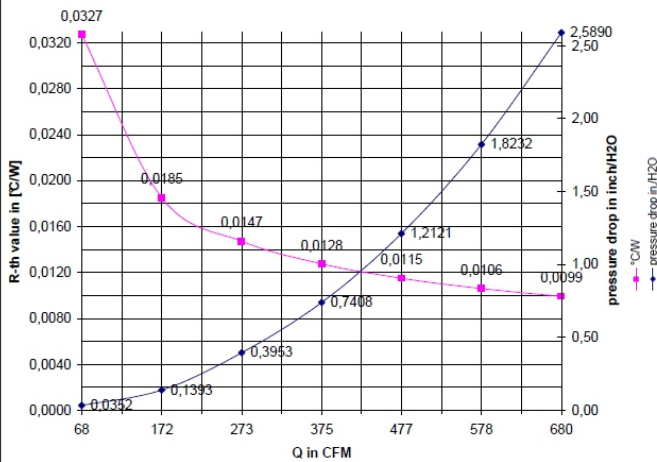
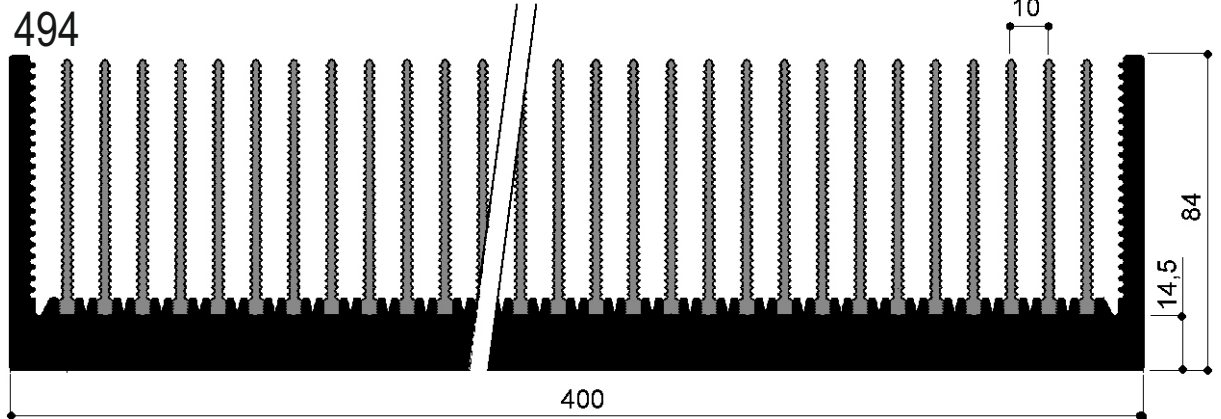
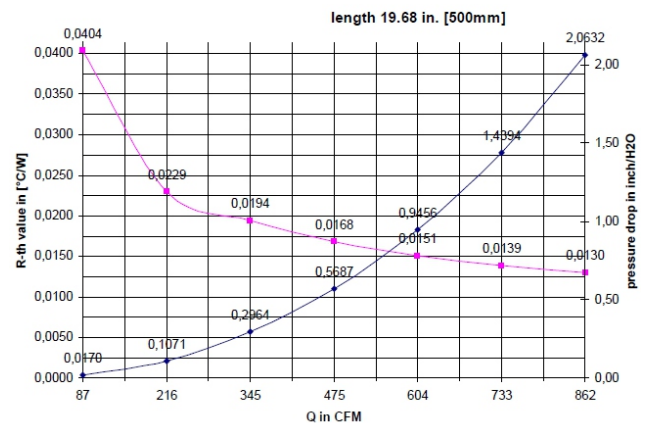

DISSIPATORI AD ALTO RENDIMENTO

DISEGNI META' DEL VERO (1:2)- SCALE 1:2

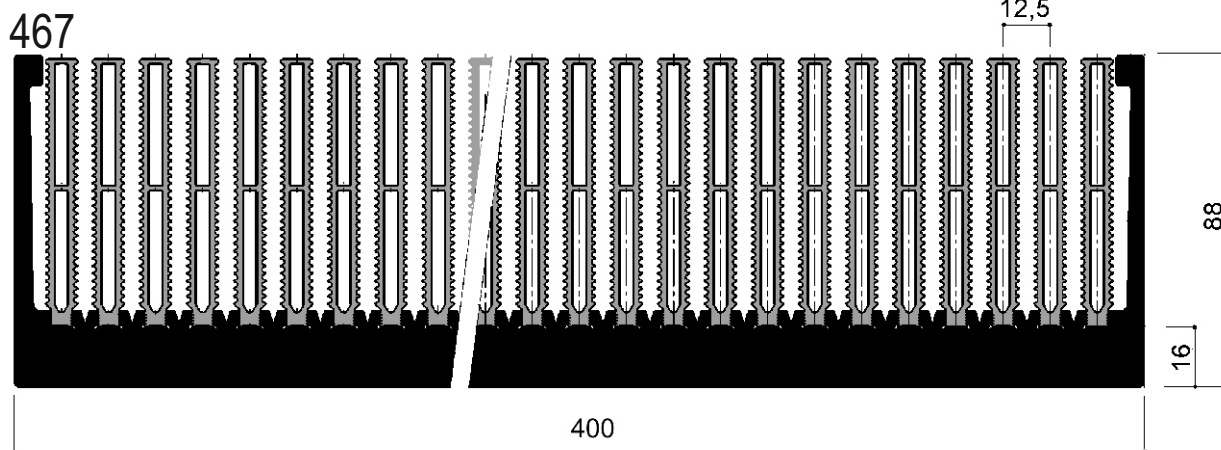

Resistenza termica (K/W) in ventilazione forzata

Lg. (mm)	100	200	300
R _{th} a 5m/s	0,036	0,026	0,019

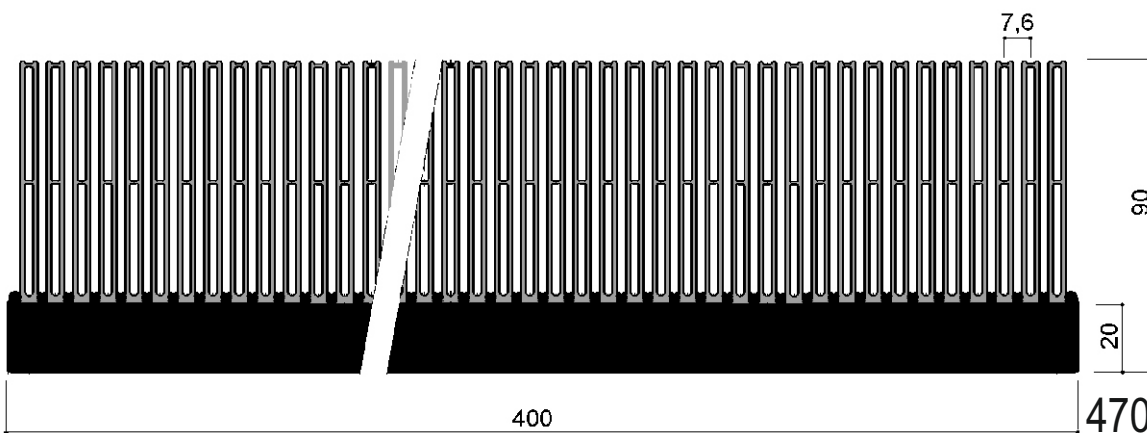
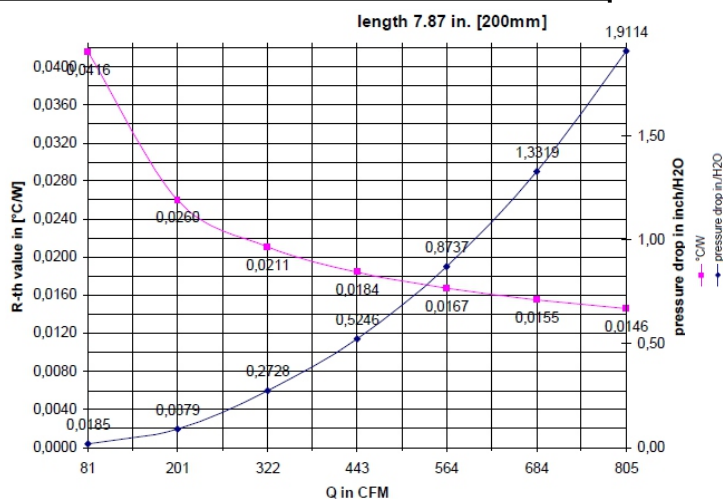

Resistenza termica (K/W) in ventilazione forzata

Lg. (mm)	200	300	400	500
R _{th} a 11m/s	0,0145	0,0115	0,0098	0,0087

length 11.81 in. [300mm]



FOTO DI ESEMPIO: TAGLIO PROFILO IN ALLUMINIO ESTRUSO PER LED DI GROSSE DIMENSIONI

Via Newton, n.12
20016 Pero (Milano - Italy)
Tel. +39 02 3535955 r.a. Fax. +39 02 3539929
E-Mail: info@omar-alluminio.it

Cataloghi Online: www.omar-alluminio.it
www.omar-alluminio.com

PROFILATI ALLUMINIO A DISEGNO / STANDARD / SPECIALI / E PER:
ELETTRONICA / LED / FOTOVOLTAICO / AUTOMAZIONE ROBOTICA / PNEUMATICA / AUTOMOTIVE

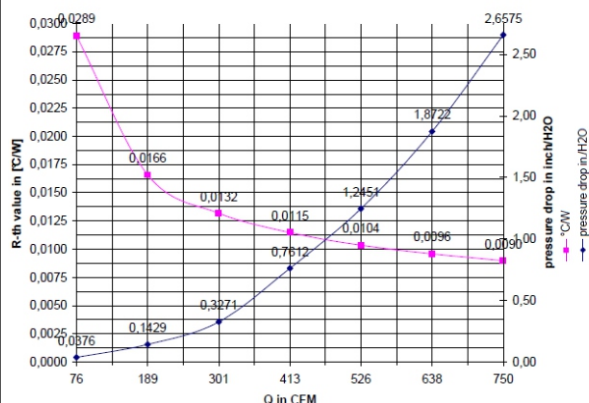

DISSIPATORI AD ALTO RENDIMENTO

DISEGNI META' DEL VERO (1:2)- SCALE 1:2

Via Newton, n.12
20016 Pero (Milano - Italy)
Tel. +39 02 3535955 r.a. Fax. +39 02 3539929
E.Mai: info@omar-alluminio.it

Cataloghi Online: www.omar-alluminio.it
www.omar-alluminio.com
PROFILATI ALLUMINIO A DISEGNO / STANDARD / SPECIALI / E PER:
ELETTRONICA / LED / FOTOVOLTAICO / AUTOMAZIONE ROBOTICA / PNEUMATICA / AUTOMOTIVE

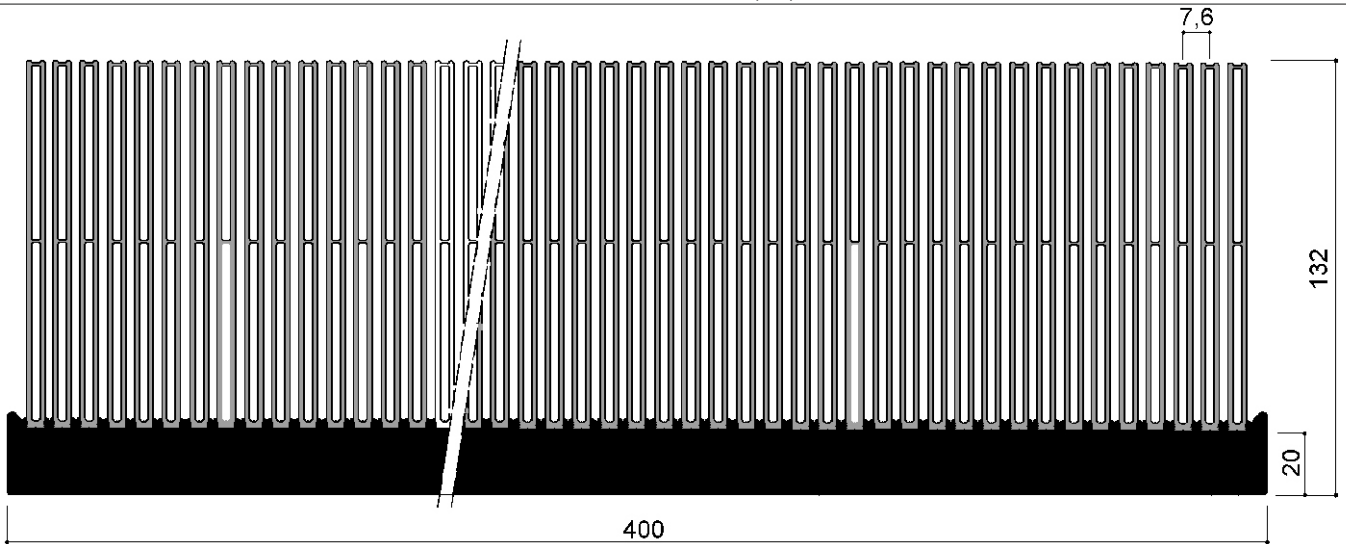

474

length 11.81 in. [300mm]

Resistenza termica (K/W) in ventilazione forzata

Lg. (mm)	200	300	400	500
R _{th} a 5m/s	0,0121	0,0092	0,0077	0,0067

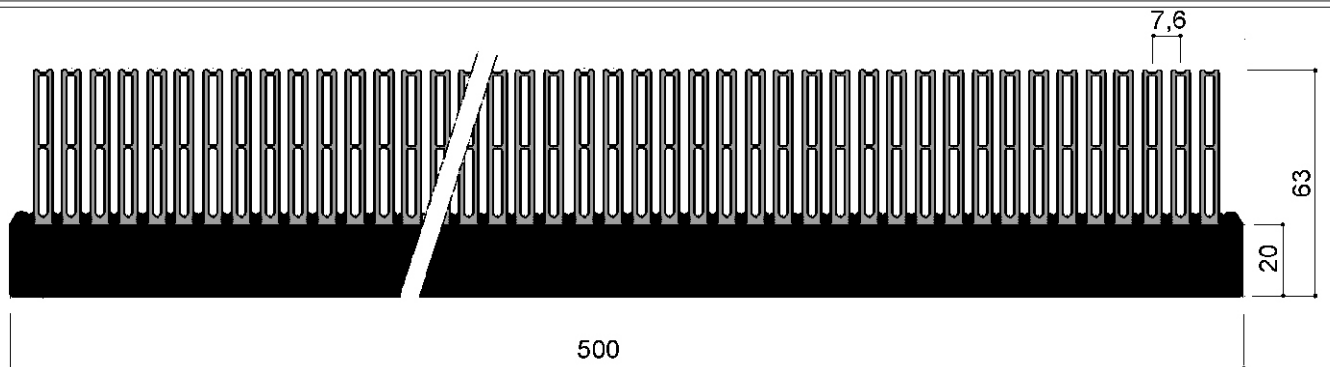
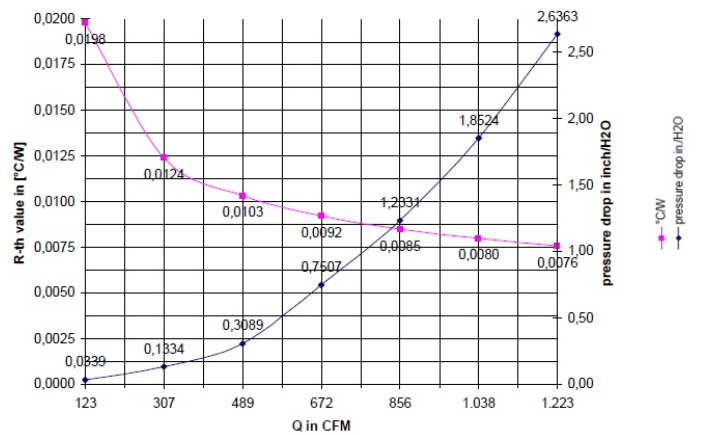

472

length 15.74 in. [400mm]

Resistenza termica (K/W) in ventilazione forzata

Lg. (mm)	200	300	400	500
R _{th} a 11 m/s	0,0162	0,0131	0,0114	0,0103

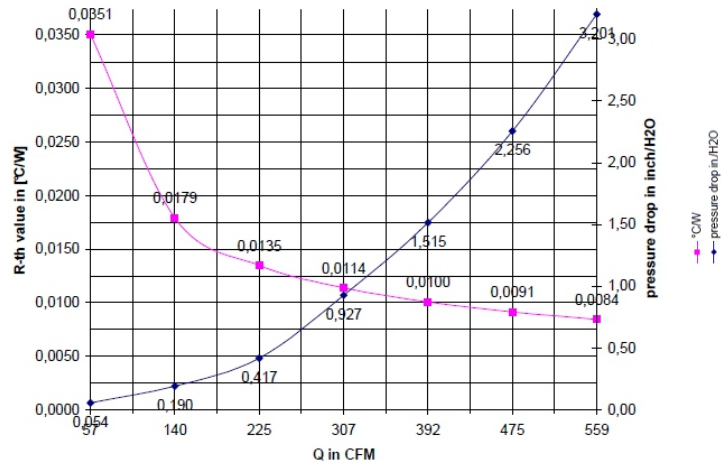

DISSIPATORI AD ALTO RENDIMENTO



DISEGNI META' DEL VERO (1:2)- SCALE 1:2

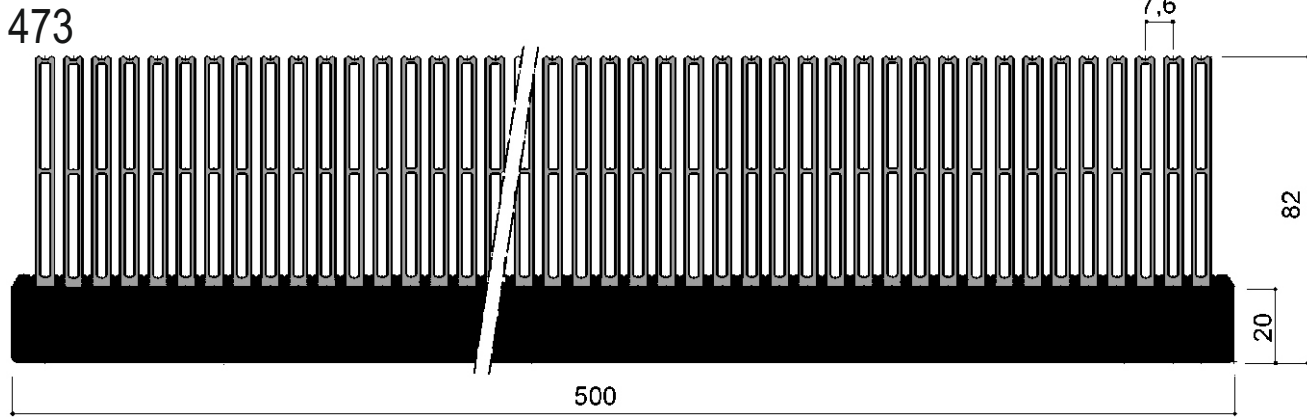

Resistenza termica (KW) in ventilazione forzata

Lg. (mm)	200	300	400	500
R _{th} a 5m/s	0,0129	0,0102	0,0087	0,0077

length 11.81 in. [300mm]

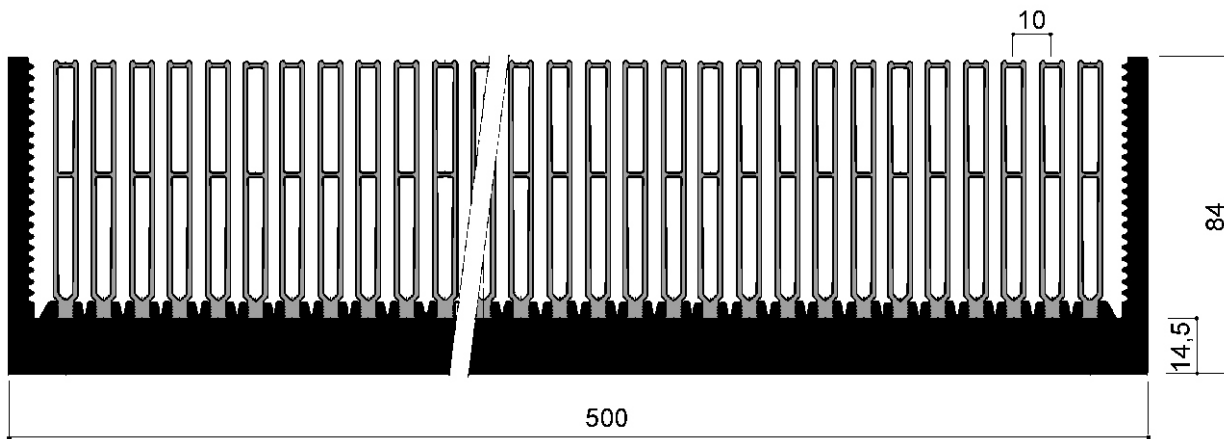
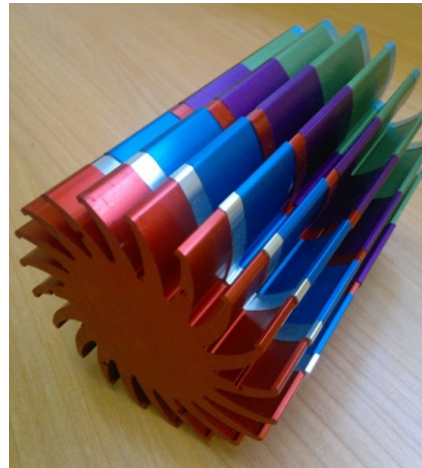
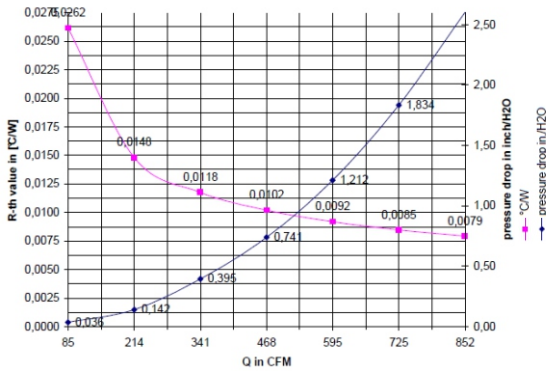

461

length 15.74 in. [400mm]

Resistenza termica (KW) in ventilazione forzata

Lg. (mm)	100	200	300	400	500
R _{th} a 5m/s	0,0324	0,0215	0,0171	0,0147	0,0131

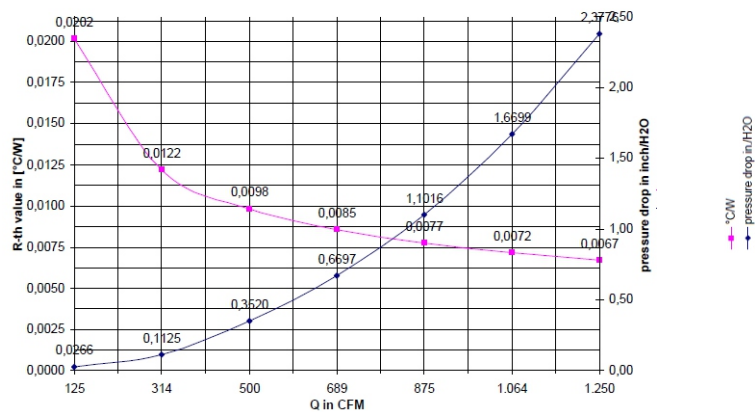

Cataloghi Online: www.omar-alluminio.it
www.omar-alluminio.com

PROFILATI ALLUMINIO A DISEGNO / STANDARD / SPECIALI / E PER:
ELETTRONICA / LED / FOTOVOLTAICO / AUTOMAZIONE ROBOTICA / PNEUMATICA / AUTOMOTIVE



Via Newton, n.12
20016 Pero (Milano - Italy)
Tel. +39 02 3535955 r.a. Fax. +39 02 3539929
E-Mail: info@omar-alluminio.it

DISSIPATORI AD ALTO RENDIMENTO



DISEGNI META' DEL VERO (1:2)- SCALE 1:2

Via Newton, n.12
20016 Pero (Milano - Italy)
Tel. +39 02 3535955 r.a. Fax. +39 02 3539929
E. Mail: info@omar-alluminio.it

Cataloghi Online: www.omar-alluminio.it
www.omar-alluminio.com
PROFILATI ALLUMINIO A DISEGNO / STANDARD / SPECIALI / E PER:
ELETTRONICA / LED / FOTOVOLTAICO / AUTOMAZIONE ROBOTICA / PNEUMATICA / AUTOMOTIVE

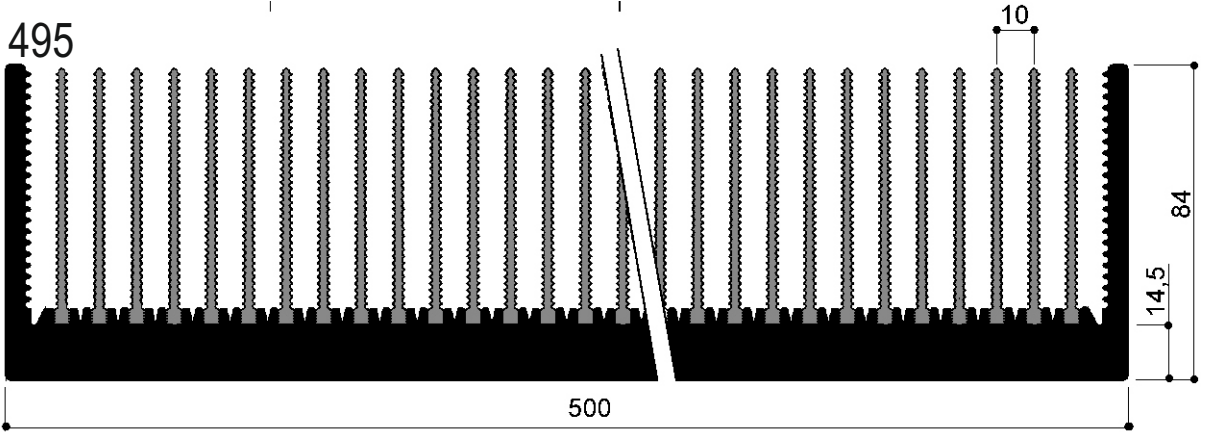

Resistenza termica (KW) in ventilazione forzata

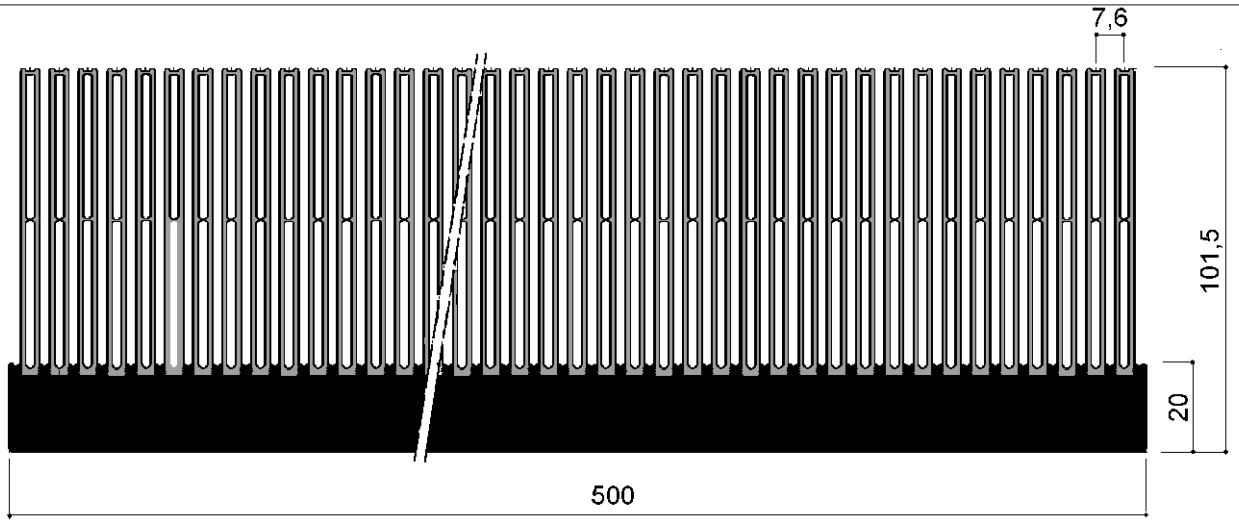
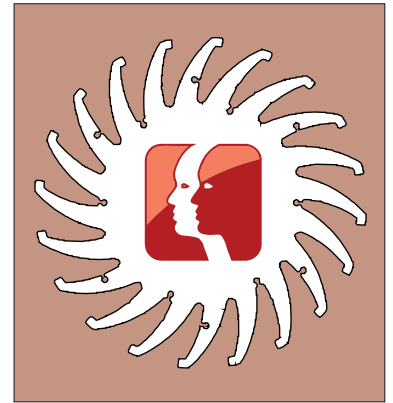
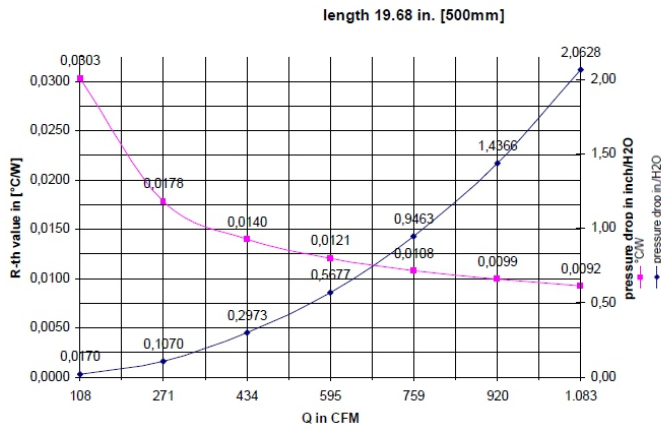

Resistenza termica (KW) in ventilazione forzata

Lg. (mm)	200	300	400	500
R _{th} a 11 m/s	0,0109	0,0085	0,0072	0,0063

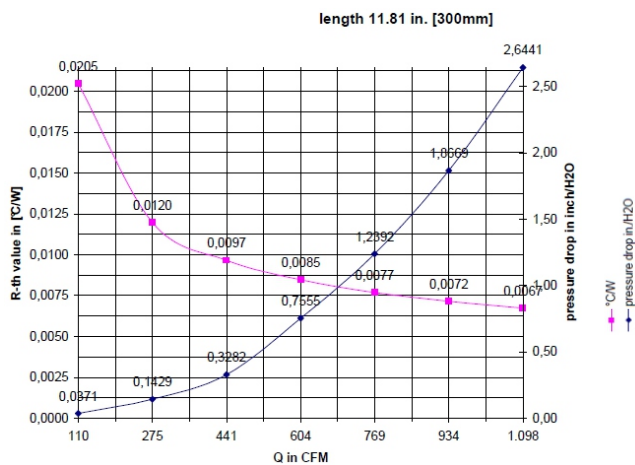

DISSIPATORI AD ALTO RENDIMENTO



DISEGNI META' DEL VERO (1:2)- SCALE 1:2

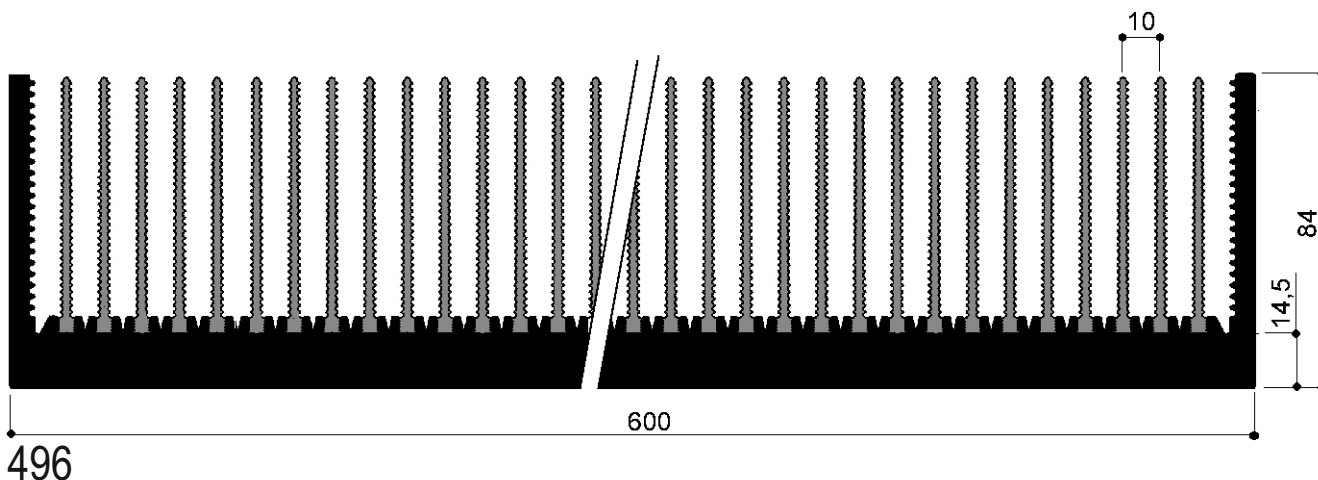
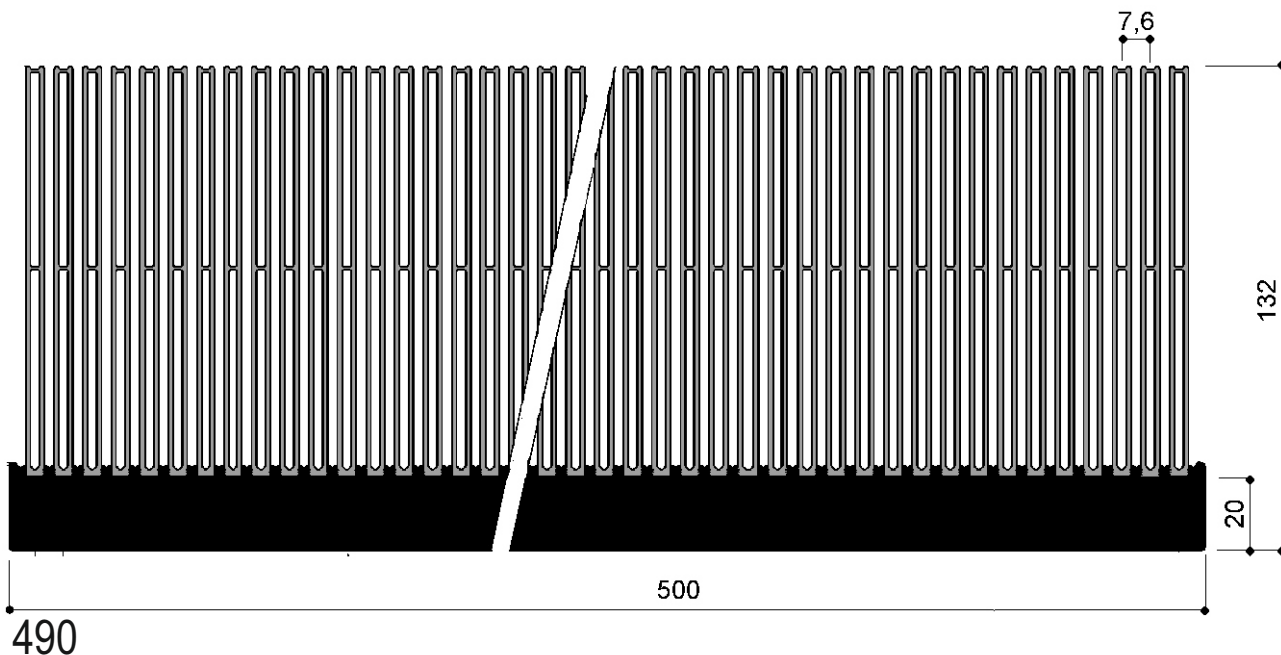

Resistenza termica (K/W) in ventilazione forzata

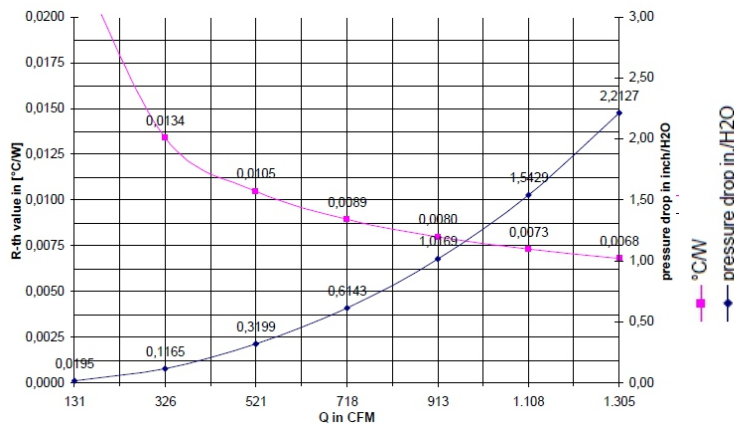

Via Newton, n.12

20016 Pero (Milano - Italy)

Tel. +39 02 3535955 r.a. Fax. +39 02 3539929

E-Mail: info@omar-alluminio.it

Cataloghi Online: www.omar-alluminio.it

www.omar-alluminio.com

PROFILATI ALLUMINIO A DISEGNO / STANDARD / SPECIALI / E PER:

ELETTRONICA / LED / FOTOVOLTAICO / AUTOMAZIONE ROBOTICA / PNEUMATICA / AUTOMOTIVE

OMAR s.p.a.
PROFILATI ALLUMINIO
ALTA TECNOLOGIA



DISSIPATORI AD ALTO RENDIMENTO

DISEGNI META' DEL VERO (1:2)- SCALE 1:2



Via Newton, n. 12
20016 Pero (Milano - Italy)
Tel. +39 02 3535955 r.a. Fax. +39 02 3539929
E. Mail: info@omar-alluminio.it

Cataloghi Online: www.omar-alluminio.it
www.omar-alluminio.com

PROFILATI ALLUMINIO A DISEGNO / STANDARD / SPECIALI / E PER:
ELETTRONICA / LED / FOTOVOLTAICO / AUTOMAZIONE ROBOTICA / PNEUMATICA / AUTOMOTIVE

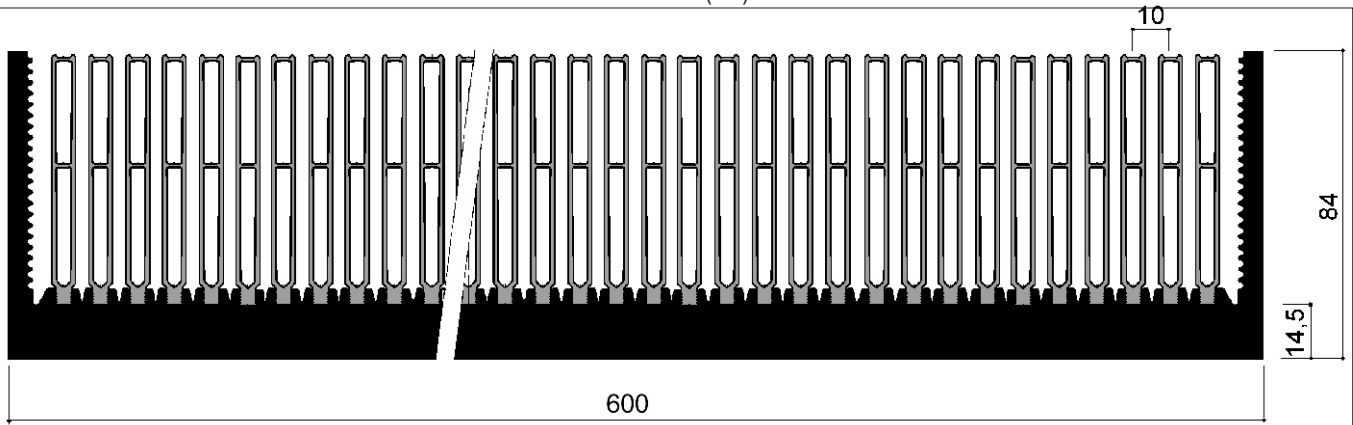

468

Resistenza termica (KW) in ventilazione forzata

Lg. (mm)	100	200	300	400	500	600
R _{th} a 11 m/s	0,0269	0,0178	0,0142	0,0122	0,0109	0,0100

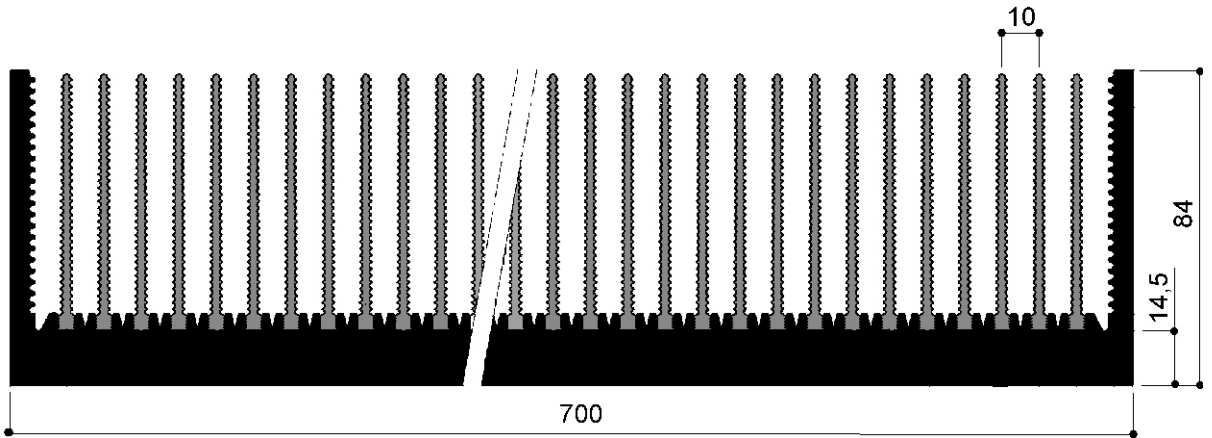
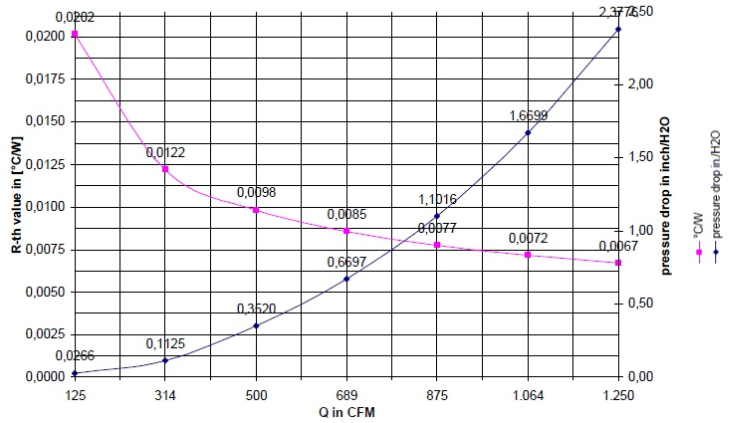

497

Resistenza termica (KW) in ventilazione forzata

Lg. (mm)	200	300	400	500	600	700
R _{th}	0,0210	0,0168	0,0143	0,0121	0,0107	0,0099

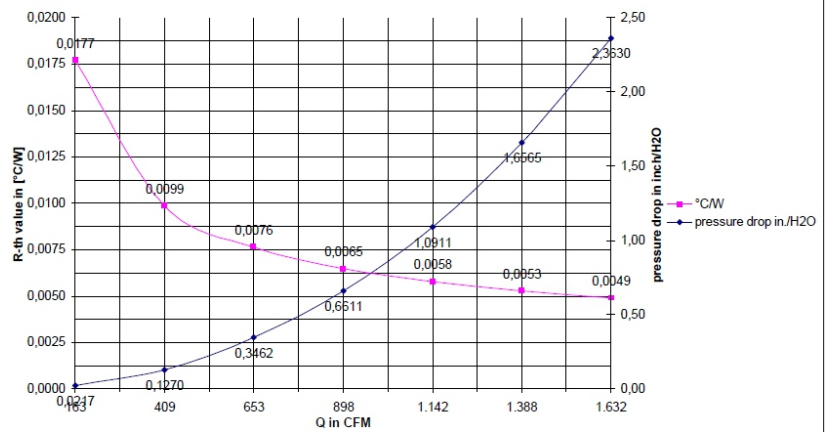

DISSIPATORI AD ALTO RENDIMENTO

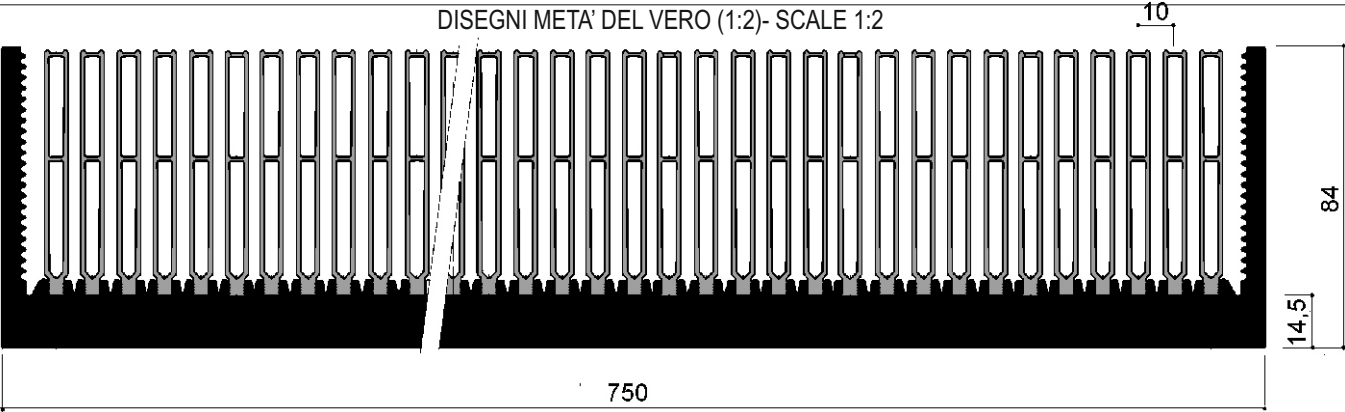

469

length 19.68 in. [500mm]

Resistenza termica (KW) in ventilazione forzata

Lg. (mm)	200	300	400	500	600	700
R _n a 5m/s	0,0142	0,0113	0,0097	0,0087	0,008	0,0074

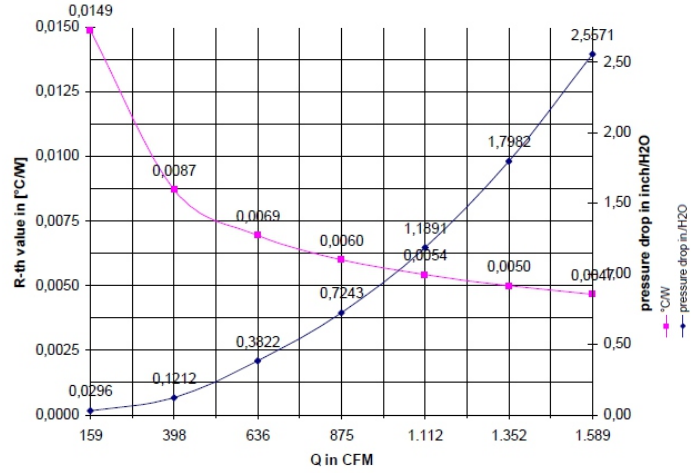

I valori espressi dalle curve sono puramente indicativi

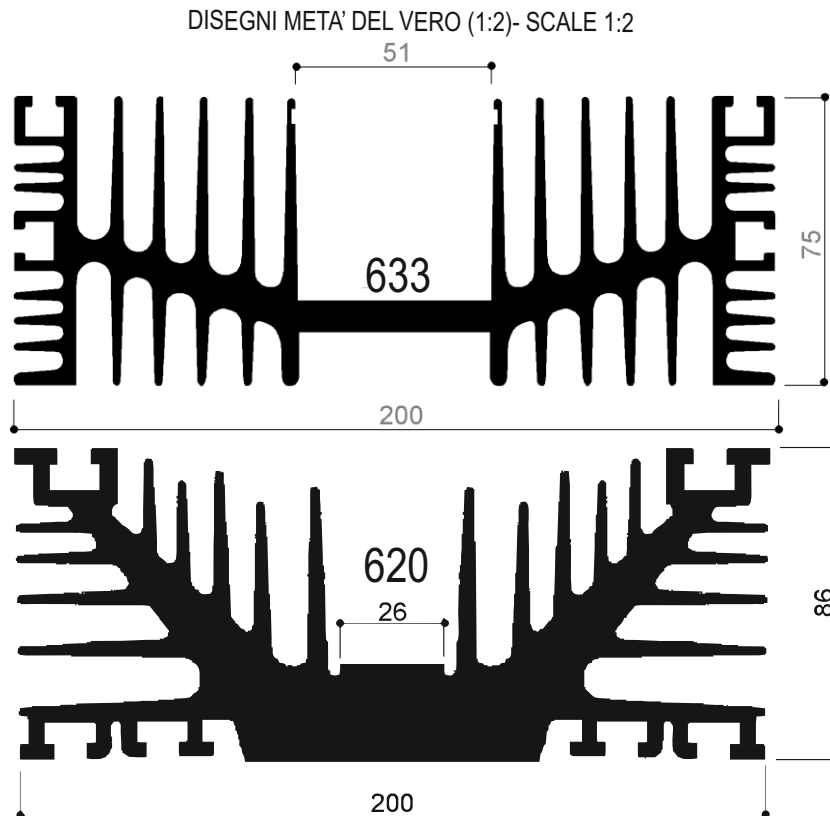

Via Newton, n.12
20016 Pero (Milano - Italy)
Tel. +39 02 3535955 r.a. Fax. +39 02 3539929
E-Mail: info@omar-alluminio.it

Cataloghi Online: www.omar-alluminio.it
www.omar-alluminio.com

PROFILATI ALLUMINIO A DISEGNO / STANDARD / SPECIALI / E PER:
ELETTRONICA / LED / FOTOVOLTAICO / AUTOMAZIONE ROBOTICA / PNEUMATICA / AUTOMOTIVE



FIERA MILANO RHO - PERO

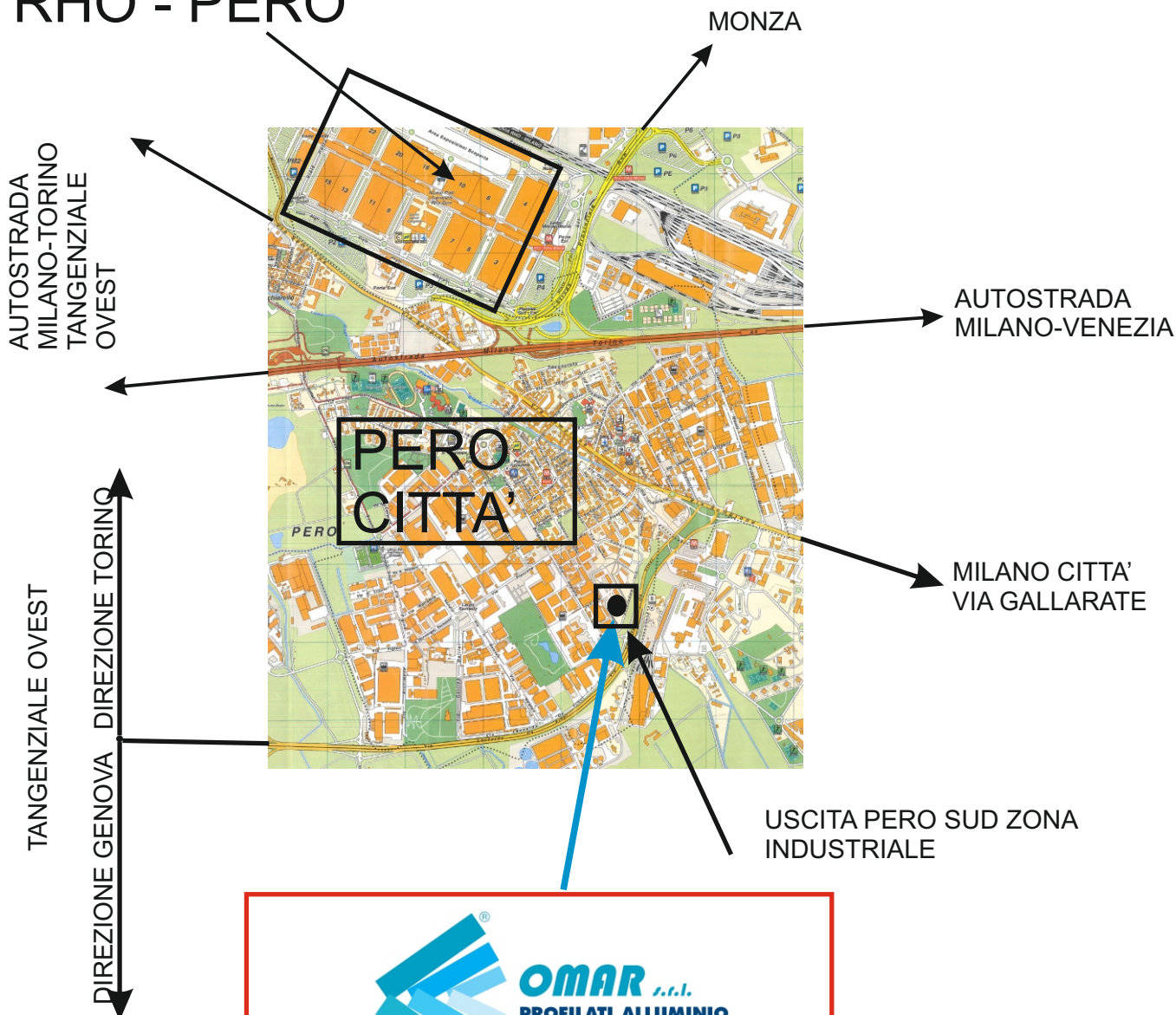

OMAR s.r.l.
PROFILATI ALLUMINIO
ALTA TECNOLOGIA

Via Newton, n.12
20016 Pero (Milano - Italy)
Tel.+39 02 3535955 r.a.
Fax.+39 02 3539929
E.Mail: info@omar-alluminio.it

Consultate il ns. catalogo aggiornato online all'indirizzo:

www.omar-alluminio.it

www.omar-alluminio.com

www.omar-alluminio.eu

PROFILATI IN ALLUMINIO
A DISEGNO-STANDARD-SPECIALI



E PER: ELETTRONICA-LED-FOTOVOLTAICO
AUTOMAZIONE ROBOTICA-PNEUMATICA-AUTOMOTIVE